



OUTDOOR

Exterior
Extérieur

2016

© LOREFAR, 2016

Referencia/Reference/Référence:

A0266

Primera edició / First edition / Première édition:
Diseño catálogo / Catalogue designer / Conception du catalogue:
Fotografía / Photography / Photographie:
Impresión / Printed by / Imprimer:

Enero / January / Janvier 2016
Faro Barcelona (Joel Polls), Empiezapori Comunicació Gràfica i Web
Guillem FH, Fotodisseny
INGOPRINT

green.
innovation



www.faro.es

About us

We are a team with international and highly professional profiles covering all phases of the lighting and fan business, from design and manufacturing to distribution.

+90 Countries in which we operate.



+3.000

Lighting & fan solutions.



+60



Years experience.



**Álex &
Manel Llusca**



Conillas



**Estudi
Ribaudí**



**Faro
Team**



**Jordi
Blasi**



**Jordi
Busquets**



**Jordi
Llopis**



**Marina
Milà**



Nahtrang



**Pepe
Llaudet**



**Alegre
Design**



**Xjer
Studio**

More than 350 registered
products. Ideas born in Barcelona.

Designers



Special luminaries
14



Series
28



Beacons & Post lamps
134



Wall & Ceiling lamps
148



Recessed
228

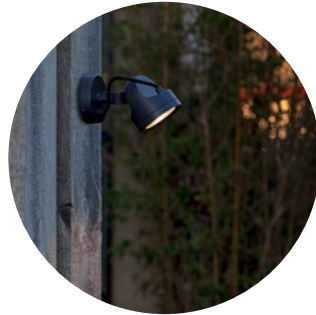

Projectors & Spikers
264



Led Strips
283

More info

292
Faro
commitment

294
Symbols

296
Materials

298
Finishes

299
Recessed
drainage

299
Beacons

299
Stainless
steel

300
IP
information

302
General
information

Grow [new]

Design: Estudi Ribaudí

We have created a conciliatory element in their environment. Looking for something hard to get ... the balance between technology and nature.



30



Sizes in mm/inch

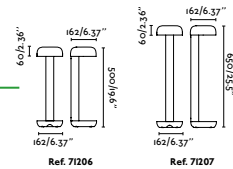

series

Energy label

[new]

Finish

Seacon		IP65	LED
Ref.	71206	● dark grey gris oscuro	
	71207	● dark grey gris oscuro	
Bulb	SMD LED 9W 3000K 720Lm incl.		
Materials	Die Cast Aluminium + Transparent Polycarbonate Aluminio Inyectado + Policarbonato Transparente		
V/Hz	100-240V / 50-60 Hz		
EEL	A++ to A		
Weight	1.5-1.86 kg / 3.31-4.10 lb		
+ info			

Bulb & consumption

Engine & diffuser material

Technique information: class, IP



Flowerpot for Grow
Macetero para Grow

71208 ● dark grey
gris oscuro

Polycarbonate
Policarbonato
0.32 kg / 0.71 lb



31



Aday
161



Alfa
266



Bracket
186



Cat
16



Flux
270



Grow
30



Half
150



Ina
215



Jarrett
20



Mera
215



Mila
137



Must
191



Nase
231



Num
183



Olan
168



Olot
211



Path
192



Plec
38



Salt
257



Shelby
34



Sun
167



Taima
181



Tami
211



Teba
181



Toluca
187



Toni
276



Tram
36



Usagui
187



Uve
230









































































Vertice
167





















































Zoe
183



Wall lamps















 [new] Aday 161	 Alp 89	 Amon 163	 Áncora 156	 Argot 218	 Askot 225	 Baco 185	 Beret 103	 Bird 49	 Blind 169
 Blub's 68	 Boletus 87	 Bonn 203	 [new] Bracket 186	 Cabo 207	 Canon 171	 Capri 175	 Cela 205	 Ceres 159	 Coal 195
 Cobo 172	 Code 154	 Crata 171	 Cripta 220	 Cross 81	 Dado 219	 Das 91	 Datna 45	 Derby 221	 Didot 173
 Dorval 205	 Dragma 157	 Ele 162	 Ellen 101	 Erio 195	 Estay 223	 Estoril 123	 Fedon 202	 Fenes 199	 Future 153
 Gina 93	 Giza 95	 Grant 193	 [new] Grow 33	 [new] Half 151	 Hepta 225	 Inari 184	 Ion 177	 Kamal 179	 Kami 176
 Keenan 189	 Klamp 58	 Kubick 200	 Lace 169	 Lacre 173	 Latina 173	 Ling 169	 Long 110	 Marat 178	 Mare 165
 Mirto 223	 Mistu 77	 Mitra 121	 Mol 197	 Moon 64	 Muffin 73	 [new] Must 191	 Naomi 185	 Natron 197	 Náutica 128

									
Neftis 177	Negus 203	Neo 105	Newport 61	Nisha 185	Nono 222	Noray 207	[new] Num 183	[new] Olan 168	Onze 117
									
Óvalo 223	Papo 175	Paris 124	Parma 219	[new] Path 192	Pistón 172	[new] Plec 39	Proa 155	Radha 165	Radio 225
									
Rondo 224	Rounder 99	Rustic 209	Saga 97	Sail 63	Sentinel 57	[new] Shelby 35	Sol 119	Sor 199	Steps 51
									
Suma 196	[new] Sun 167	[new] Taima 181	Tane 172	Tarraco 115	[new] Teba 181	Tejo 197	Terra 221	Tinia 175	[new] Toluca 187
									
[new] Tram 37	[new] Usagui 187	[new] Vertice 167	View 152	Visnu 209	Wally 219	West 201	Wilma 107	Yak 55	[new] Zoe 183



































Ceilings lamps

							
Dakron 217	Dakyu 217	[new] Ina 215	[new] Mera 215	[new] Olot 211	[new] Tami 211	Tasa 213	Yen 216

Pendant lamps

									
Blub'S 71	Ellen 101	Estoril 122	Mistu 78	Mitra 121	Moon 67	Muffin 75	Náutica 129	Newport 61	Paris 125
									
[new] Plec 39	[new] Plec 41	Sail 63	Wilma 107						

Recessed

									
Bastet 243	Carter 245	Citrus 239	Crosby 253	Curtis 252	Edel 257	Esca 247	Filter 237	Horus 235	Indi 241
									
Landai 240	Led -15 259	Led -16 259	Led -18 249	Led -19 261	Lio 261	Liso 247	Metric 237	Mini Carter 245	Mini Contra 246
									
Mini Geo 247	Mini Racing 244	Mysore 262	[new] Nase 231	Racing 245	[new] Salt 257	Sedna 233	Store 237	Sula 241	Suria 255
									
Taro 253	Tecno -1 259	Tecno -6 263	Tecno -8 258	[new] Uve 230					

Projectors



[new]
Alfa
267



Apolo
275



Aran
271



Aton
271



[new]
Flux
270



Garten
281



Gera
271



Nava
274



Onda
275



Pola
281



Project
269



Toran
273

Spikes



Balder
277



Sobek
277



[new]
Toni
276



Tono
281



Garten
279



Seth
278

Post lamps



Blub'S
69



Boletus
87



Cartago
113



Cross
81



Datna
45



Giza
95



Long
111



[new]
Mila
137



Mistu
77



Moon
65



Muffin
73



Naya
141



Paris
125



Sol
119



Tau
43



Wilma
109

Portables



Balda
27



Boo
26



[new]
Cat
17



Cross
80



[new]
Jarrett
21



Nuk
25



Versus
22

Pole lamps



Beret
102



Blub's
70

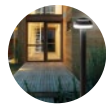

Boletus
86



Cartago
112



Cross
83



Datna
47



Mistu
79



Moon
67



Muffin
74



Náutica
132



Paris
126



Sol
118

Beacons



Agra
143



Alp
89



Aristo
145



Beret
103



Bird
49



Blub's
69



Boletus
87



Cartago
113



Chandra
142



Cross
82



Das
91



Datna
47



Gina
93



Giza
95



[new]
Grow
31

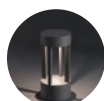

Jaipur
137



Klamp
59



Long
111



Mistu
77



Moon
65

									
Muffin 73	Naya 141	Neo 105	Onze 117	Rounder 99	Saga 97	Sentinel 57	Sete 138	Shelby 35	Sol 119
									
Sora 139	Steps 53	Surat 139	Tarraco 115	Tau 43	Tram 37	Verno 145	Wilma 109	Yak 55	

Balda	27
Boo	26
Cat [new]	16
Jarrett [new]	20
Nuk	24
Versus	22



Cat [new]

Design: Nahtrang

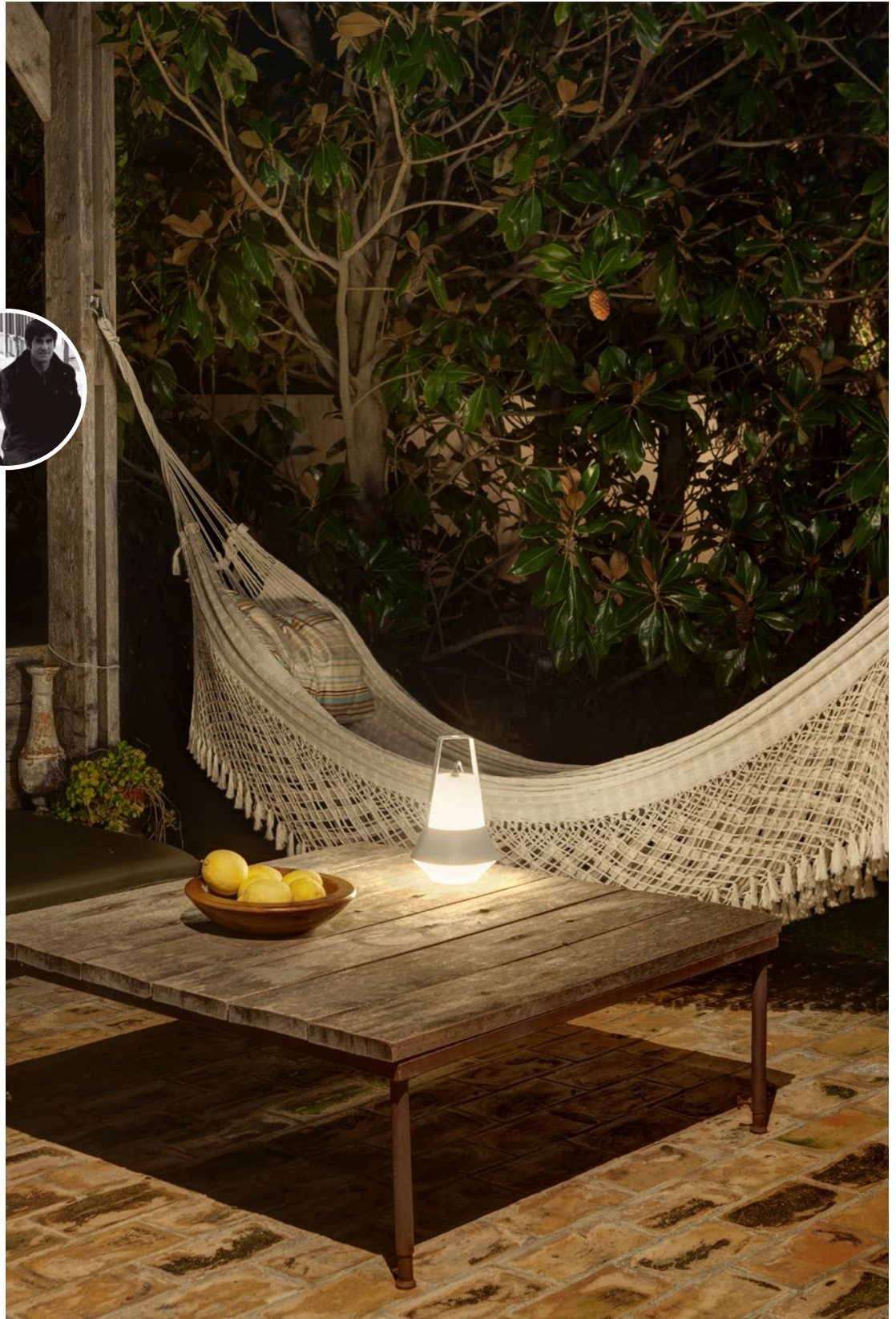

One way, as restless as direct, invites you to put each piece as a company point wherever you go.

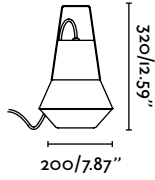



[new]

Portable

Ref.	71562		black negro
	71563		white blanco
	71564		red rojo

Bulb 1xE27 20W not incl. [LED 17453]

Materials Aluminium + PEMD
Aluminio + PEMD

V/Hz 100-240V / 50-60 Hz

EEL A++ to B

Weight 0.67 kg / 1.48 lb

+ info   





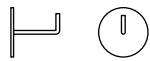

71556

Die Cast Aluminium
Aluminio Inyectado
0,07 kg / 0.15 lb

Jarrett [new]

Design: Àlex&Manel
Llusçà







We have
looked for a daily
form to illuminate our
more informal spaces.





[new]

Portable

Ref.	70477		orange naranja
	70478		green verde
	70479		grey gris
	70480		fuchsia fúcsia

Bulb E27x60W not incl. [LED I7457]

Materials PEMD + Translucent Opal
PEMD + Opal Translucido

V/Hz 100-240V / 50-60 Hz

EEL A++ to E

Weight 3.42 kg / 7.54 lb

+ info

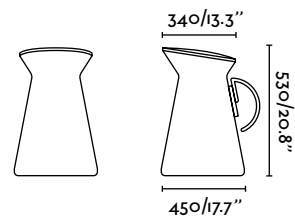
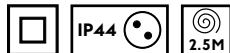

Versus

Design: Pepe Llaudet



Simple, easily-integrated and versatile. A contemporary object with a classic geometrical design formed from two conical elements.

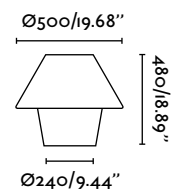

Table Lamp

MADE IN SPAIN
HECHO EN ESPAÑA



Ref.	74423  white blanco
Bulb	1xE27 20W not incl. [LED 17457]
Materials	PEMD PEMD
V/Hz	100-240V / 50-60 Hz
EEL	A++ to B
Weight	4.1 kg / 9.04 lb

+ info

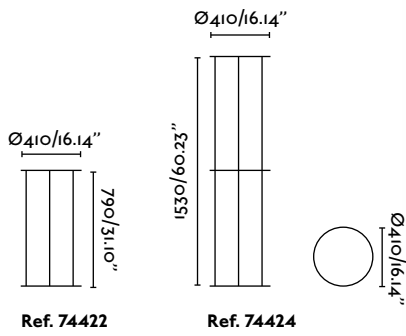



Structure

Ref.	74422		black negro
	74424		black negro

Materials Steel
Acero

Weight 14 kg / 30.86 lb



Nuk







Design: Àlex&Manel
Llusçà

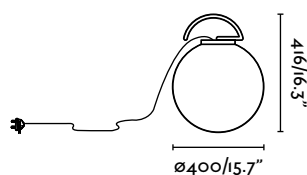

Relaxation
and enjoyment come
with nuk, a highly deco-
rative portable lamp
Intended to fully enjoy
life in the outdoors.





Portable	
Ref.	<p>70484  orange naranja</p> <p>70485  lime green verde lima</p> <p>70486  grey gris</p> <p>70487  fuchsia fúcsia</p>
Bulb	1xE27 max 60W not incl. [LED 17457]
Materials	PMMA PMMA
V/Hz	100-240V / 50-60 Hz
EEl	A++ to E
Weight	0.6 kg / 1.32 lb
+ info	  



ERGONOMIC

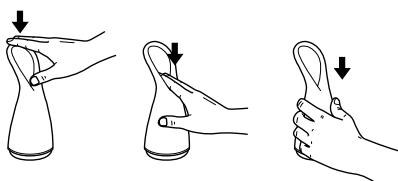

DIMMABLE 3 INTENSITIES
DIMABLE 3 INTENSIDADES

LED BATTERY NOT INCL.
PILAS NO INCLUIDAS
4XAA TOUCH LAMP
LAMPARA TACTIL

BOO

Portable

Ref. **70492**  white
blanco

Bulb LED 3W 3000K incl.

Materials Opal ABS
Opal ABS

V/Hz 6V

Weight 0.35 kg / 0.77 lb

+ info  IP44

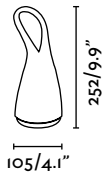



BALDA

IP65

Portable

Ref.	70498		white blanco
	70499		white blanco

Bulb 1xE27 15W not incl. [LED 17453]





Materials Opal Polyethylene
Polietileno Opal

V/Hz 100-240V / 50-60 Hz

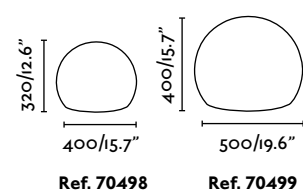
EEL A++ to B

Weight 2 kg / 4.41 lb



+ info    

Alp	88	Paris	124
Beret	102	Plec <small>[new]</small>	38
Bird	48	Rounder	98
Blub's	68	Saga	96
Boletus	86	Sail	62
Cartago	112	Sentinel	56
Cross	80	Shelby <small>[new]</small>	34
Das	90	Sol	118
Datna	44	Steps	50
Ellen	100	Tarraco	114
Estoril	122	Tau	42
Gina	92	Tram <small>[new]</small>	36
Giza	94	Wilma	106
Grow <small>[new]</small>	30	Yak	54
Klamp	58		
Long	110		
Mistu	76		
Mitra	120		
Moon	64		
Muffin	72		
Náutica	128		
Neo	104		
Newport	60		
Onze	116		



Grow [new]



Design: Estudi Ribaudf



We have created a conciliatory element in their environment. Looking for something hard to get ... the balance between technology and nature.



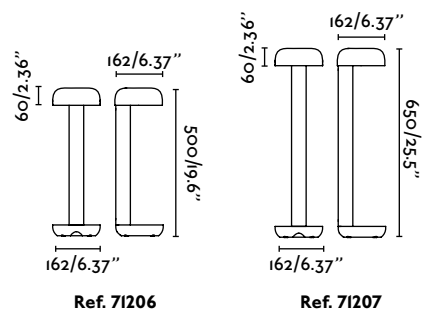

[new]

Beacon

IP65

LED

Ref.	71206	● dark grey gris oscuro
	71207	● dark grey gris oscuro

Bulb SMD LED 9W 3000K 720Lm incl.

Materials Die Cast Aluminium + Transparent Polycarbonate
Aluminio Inyectado + Policarbonato Transparente

V/Hz 100-240V / 50-60 Hz**EEL** A++ to A**Weight** 1.5-1.86 kg / 3.31-4.10 lb

+ info



IP65

DRIVER ✓

Flowerpot for Grow
 Macetero para Grow

71208 ● dark grey
gris oscuro

 Polycarbonate
 Policarbonato

0.32 kg / 0.71 lb





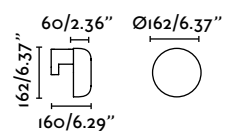
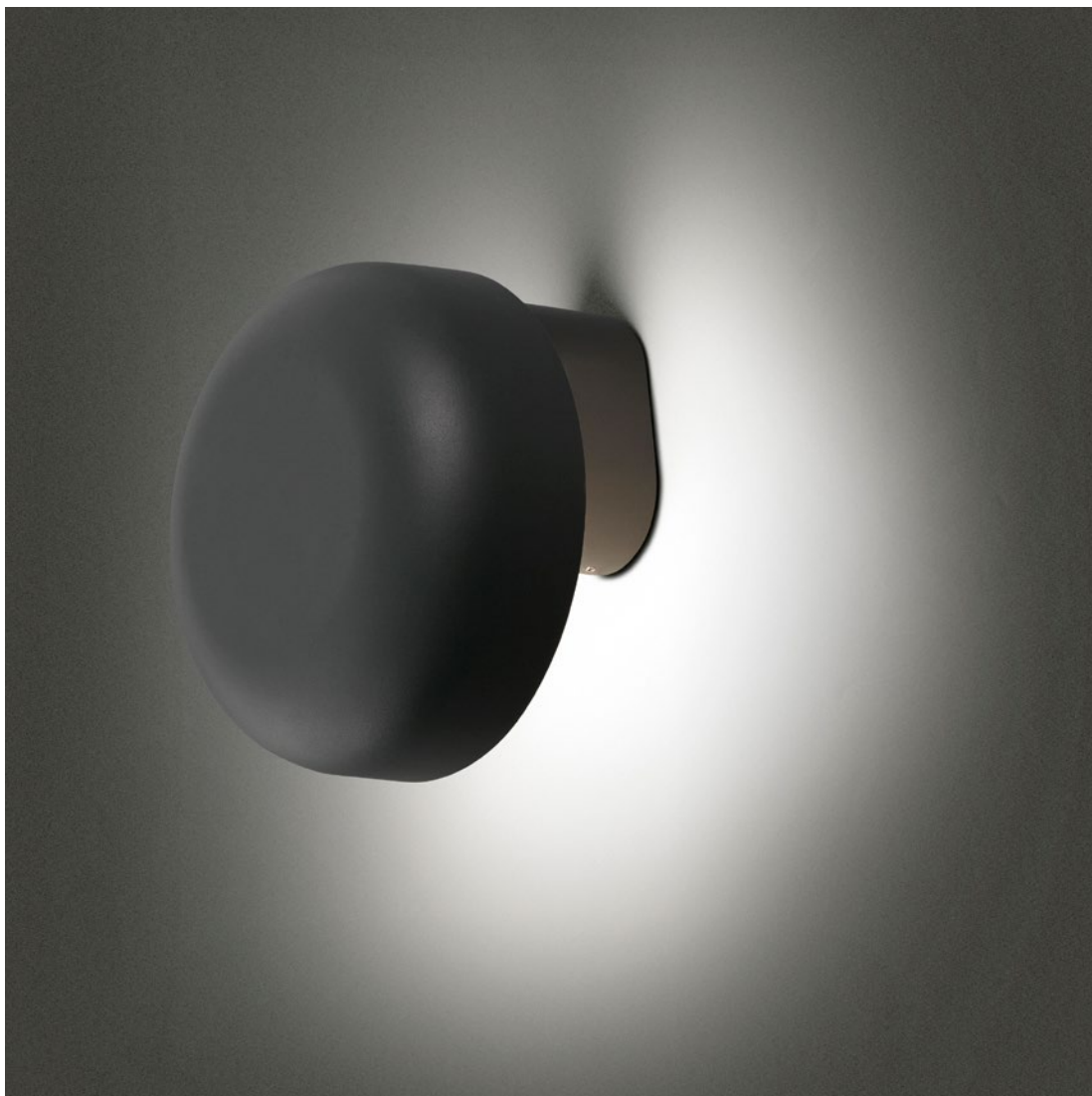

[new]

**Wall
Lamp**

LED

Ref. 71205  dark grey
gris oscuro

Bulb SMD LED 9W 3000K 720Lm incl.

Materials Die Cast Aluminium + Transparent Polycarbonate
Aluminio Inyectado + Policarbonato Transparente

V/Hz 100-240V / 50-60 Hz

EEL A++ to A

Weight 0.92 kg / 2.03 lb

+ info



IP44

DRIVER 

Shelby [new]

Design: Conillas



Shelby is the revision of a classic. Applying new technology, we have improved its performance. A model that provides light at 360°.

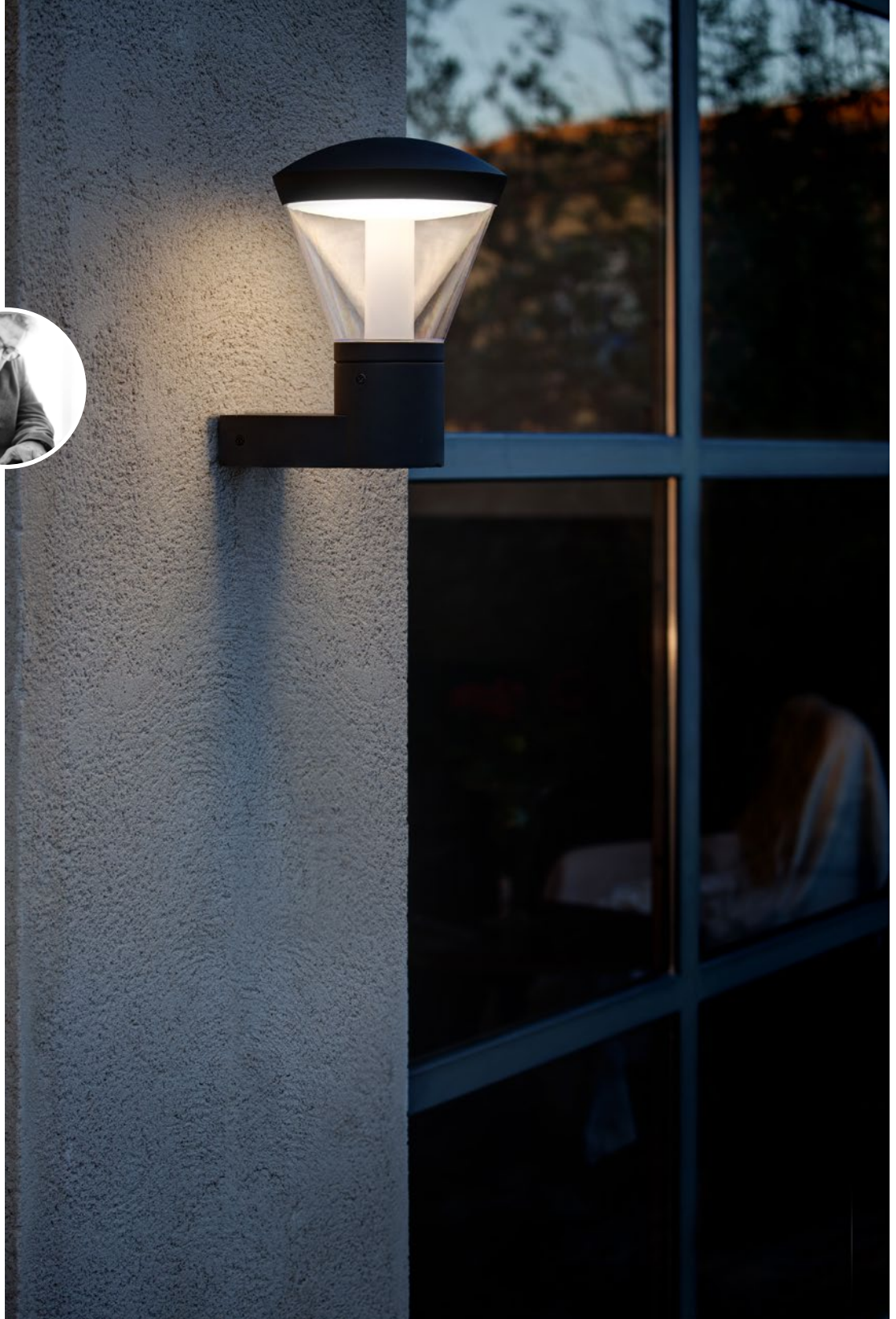

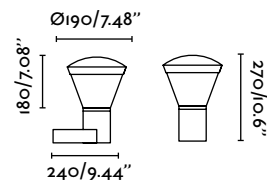

[new]

Wall Lamp

LED

Ref.	75536	● dark grey gris oscuro
Bulb	SMD LED 10W 3000K 700Lm incl.	
Materials	Die Cast Aluminium + Transparent Polycarbonate Aluminio Inyectado + Policarbonato Transparente	
V/Hz	100-240V / 50-60 Hz	
EEL	A++ to A	
Weight	1.5 kg / 3.31 lb	

+ info

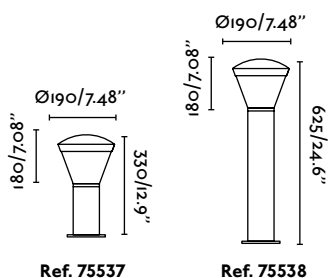

Ref. 75537

Ref. 75538

[new]

Beacon

IP65

LED

Ref.	75537	● dark grey gris oscuro
	75538	● dark grey gris oscuro
Bulb	SMD LED 10W 3000K 700Lm incl.	
Materials	Die Cast Aluminium + Transparent Polycarbonate Aluminio Inyectado + Policarbonato Transparente	
V/Hz	100-240V / 50-60 Hz	
EEL	A++ to A	
Weight	1.38-1.97 kg / 3.04-4.34 lb	

+ info



Ref. 75537

Ref. 75538

Tram [new]

Design: Estudi Ribaudí



Tram is a beacon that fits spaces adding value and harmony. Simple shapes, elegance, to create natural spaces, in perfect harmony.





[new]

Wall Lamp

Ref.	75529		dark grey gris oscuro
	75533		white blanco

Bulb 1xE27 20W not incl. [LED 17453]**Materials** Aluminium + Polycarbonate
Aluminio + Policarbonato**V/Hz** 100-240V / 50-60 Hz**EEL** A++ to B**Weight** 0.71 kg / 1.57 lb

+ info



IP44

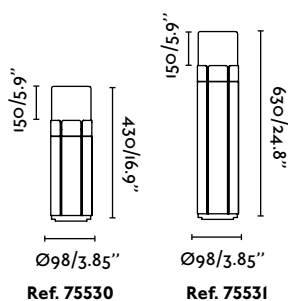
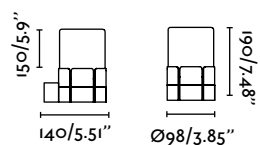

[new]

Beacon

IP65

Ref.	75530		dark grey gris oscuro
	75531		dark grey gris oscuro

Bulb 1xE27 20W not incl. [LED 17453]**Materials** Aluminium + Polycarbonate
Aluminio + Policarbonato**V/Hz** 100-240V / 50-60 Hz**EEL** A++ to B**Weight** 1.3-1.64 kg / 2.87-3.62 lb

+ info



IP65



Ref. 75530

Ref. 75531

Plec [new]

Design: Àlex&Manel
Llusçà



To create the collection PLEC we have been inspired by the old, but near, post-industrial trends.



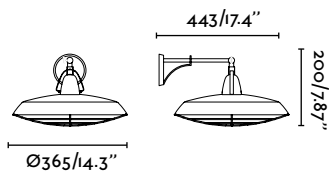



[new]

Wall
Lamp

LED

Ref. **66208**  old brown
marrón envejecido

66209  off white
blanco roto

Bulb SMD LED 15W 2700K | 200Lm incl.

Materials Steel + PVC
Acero + PVC

V/Hz 220-240V / 50-60 Hz

EEl A++ to A

Weight 1.83 kg / 4.03 lb

+ info

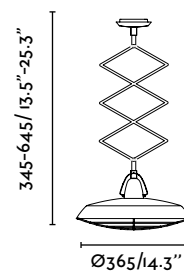

IP44

DRIVER 

[new]

Extensible
Pendant
Lamp | L

LED

Ref. **66212**  old brown
marrón envejecido

66213  off white
blanco roto

Bulb SMD LED 15W 2700K | 200Lm incl.

Materials Steel + PVC
Acero + PVC

V/Hz 220-240V / 50-60 Hz

EEl A++ to A

Weight 2.52 kg / 5.56 lb

+ info



IP44

DRIVER 



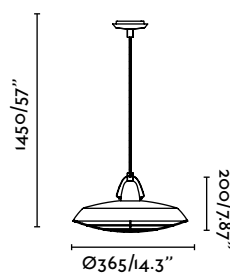

[new]

**Pendant
Lamp 1L**

LED

Ref.	66210		old brown marrón envejecido
	66211		off white blanco roto

Bulb	SMD LED 15W 2700K 1200Lm incl.
-------------	--------------------------------

Materials	Steel + PVC Acero + PVC
------------------	----------------------------

V/Hz	220-240V / 50-60 Hz
-------------	---------------------

EEL	A++ to A
------------	----------

Weight	1.8 kg / 3.97 lb
---------------	------------------

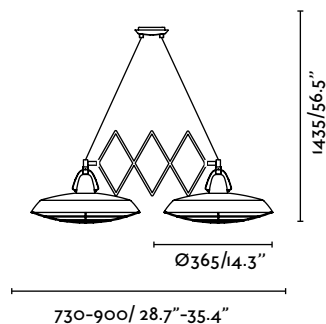

+ info



[new]

**Extensible
Pendant
Lamp 2L**

LED

Ref.	66214		old brown marrón envejecido
	66215		off white blanco roto

Bulb	SMD 2xLED 15W 2700K 2400Lm incl.
-------------	----------------------------------

Materials	Steel + PVC Acero + PVC
------------------	----------------------------

V/Hz	220-240V / 50-60 Hz
-------------	---------------------

EEL	A++ to A
------------	----------

Weight	4.21 kg / 9.28 lb
---------------	-------------------

+ info

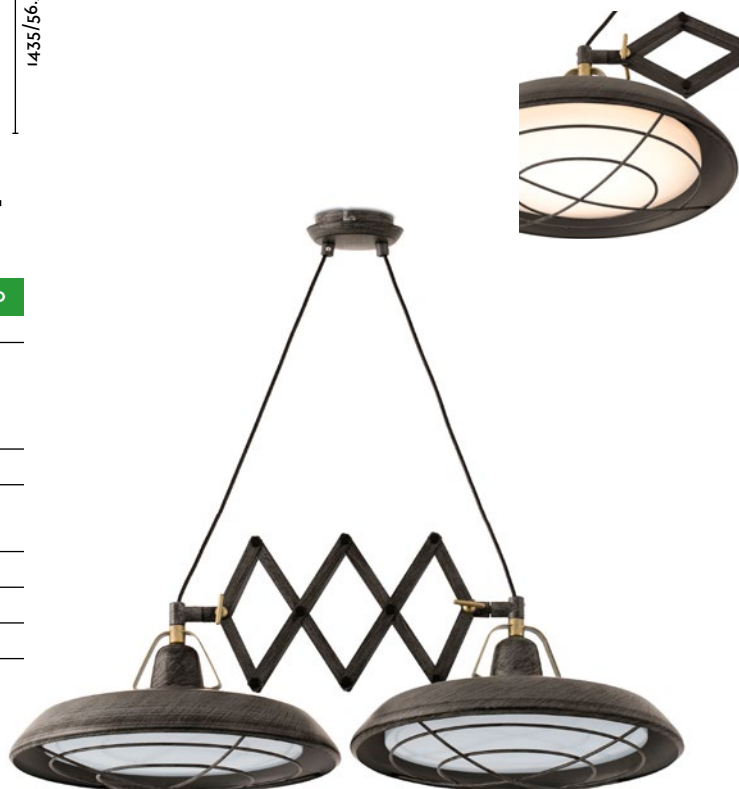

Tau

Design: Àlex&Manel
Llusçà

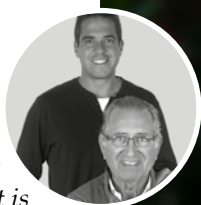

An outdoor collection that is characterized by its sober and architectural lines.

Tau presents a compact and solid design, making it a solution for highly aesthetic outdoor lighting.

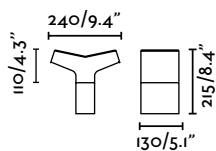

**Post Lamp**

Ref.	74446  dark grey gris oscuro
Bulb	1xE27 max 20W not incl. [LED 17455]
Materials	Die Cast Aluminium + Opal Polycarbonate Aluminio Inyectado + Policarbonato Opal
V/Hz	100-240V / 50-60 Hz
EEL	A++ to A
Weight	0.86 kg / 1.90 lb

+ info

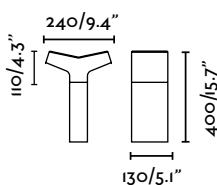
**Beacon**

Ref.	74447  dark grey gris oscuro
Bulb	1xE27 max 20W not incl. [LED 17455]
Materials	Die Cast Aluminium + Opal Polycarbonate Aluminio Inyectado + Policarbonato Opal
V/Hz	100-240V / 50-60 Hz
EEL	A++ to A
Weight	1.34 kg / 2.95 lb

+ info

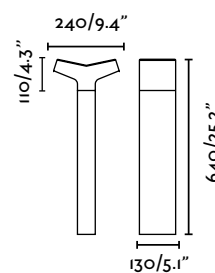
**Beacon**

Ref.	74448  dark grey gris oscuro
Bulb	1xE27 max 20W not incl. [LED 17455]
Materials	Die Cast Aluminium + Opal Polycarbonate Aluminio Inyectado + Policarbonato Opal
V/Hz	100-240V / 50-60 Hz
EEL	A++ to A
Weight	1.51 kg / 3.33 lb

+ info



Datna

Design: Àlex & Manel
Llusçà



Seeing integration with the urban landscape and new architecture, we provide a minimalist design with a single volume.

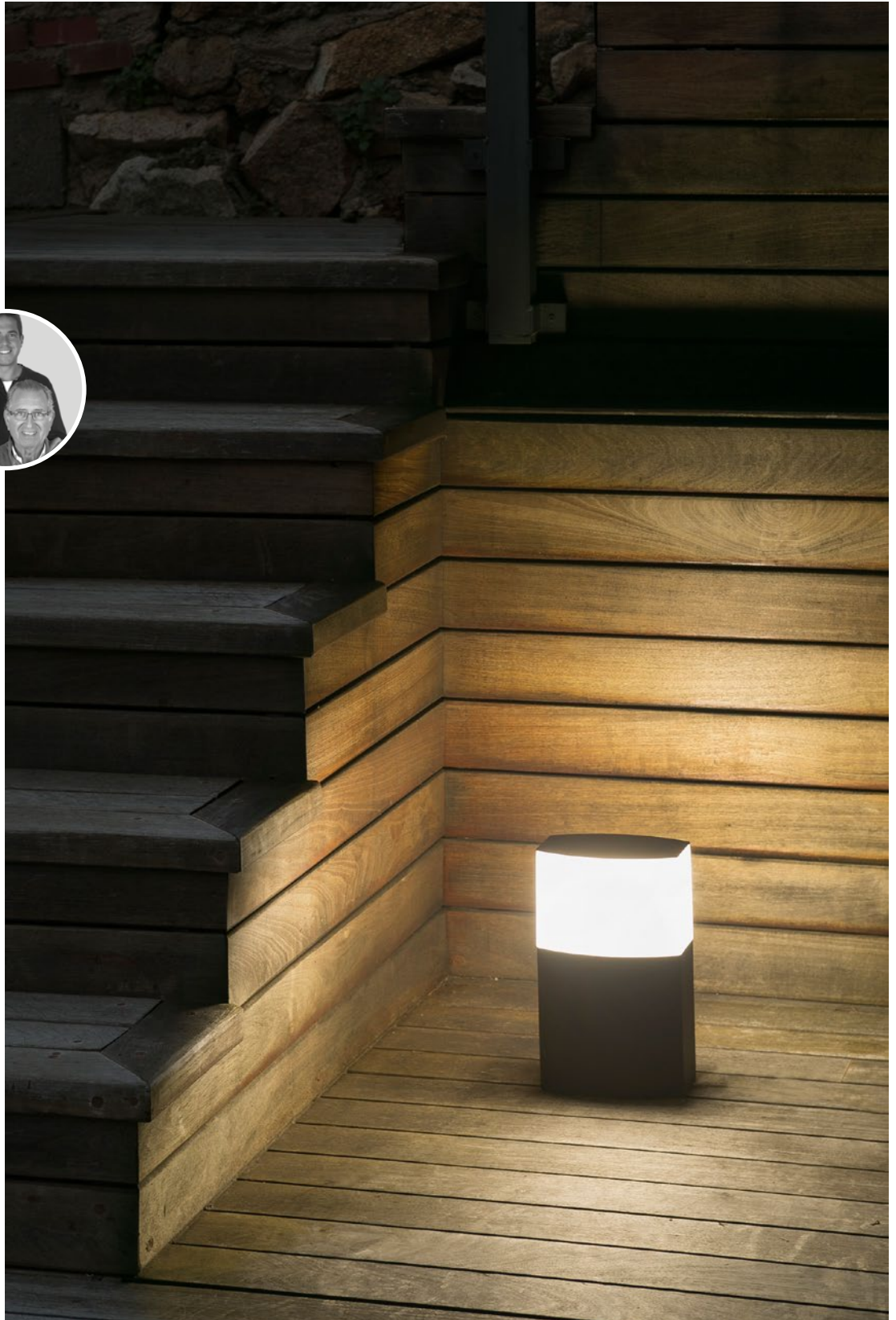



Wall Lamp

Ref. 74440  dark grey
gris oscuro

Bulb 1xE27 max 20W not incl. [LED 17453]

Materials Die Cast Aluminium + Opal Polypropilene
Aluminio Inyectado + Polipropileno Opal

V/Hz 100-240V / 50-60 Hz

EEL A++ to B

Weight 1.1 kg / 2.43 lb

+ info

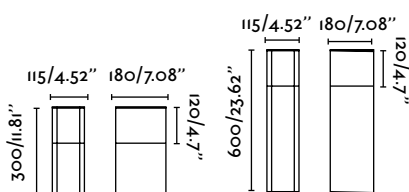

Post Lamp / Beacon

Ref. 74441  dark grey
gris oscuro

74442  dark grey
gris oscuro

Bulb 1xE27 max 20W not incl. [LED 17453]

Materials Die Cast Aluminium + Opal Polypropilene
Aluminio Inyectado + Polipropileno Opal

V/Hz 100-240V / 50-60 Hz

EEL A++ to B

Weight 1.3-2.4 kg / 2.87-5.29 lb

+ info



Ref. 74441

Ref. 74442

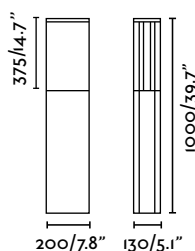

**Beacon** LED

IP65 LED

[new]

Ref.	74443L  dark grey gris oscuro
Bulb	COB LED 38W 4000K 3800Lm CRI>85 incl.
Materials	Die Cast Aluminium + Opal Polycarbonate Aluminio Inyectado + Policarbonato Opal
V/Hz	220-240V / 50-60 Hz
EEl	A++ to A

+ info



IP65

DRIVER **Beacon** PL

IP65

Ref.	74443  dark grey gris oscuro
Bulb	1xPL 2GII 36W not incl. [15923]
Materials	Die Cast Aluminium + Opal Polycarbonate Aluminio Inyectado + Policarbonato Opal
V/Hz	220-240V / 50-60 Hz
EEl	A++ to B
Weight	2.4 kg / 5.29 lb

+ info

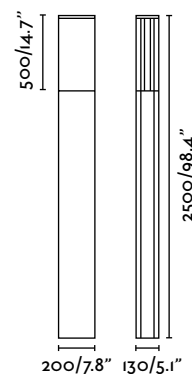

IP65

BALLAST **Pole Lamp**

IP65

Ref.	74444  dark grey gris oscuro
Bulb	1x2GII 55W not incl. [15925]
Materials	Die Cast Aluminium + Opal Polycarbonate Aluminio Inyectado + Policarbonato Opal
V/Hz	220-240V / 50-60 Hz
EEl	A++ to B
Weight	8.3 kg / 18.30 lb

+ info



IP65

BALLAST 

Bird

Design: Estudi Ribaudf





Bird is inspired by Japanese origami, a culture that sought permanent harmony in open spaces.

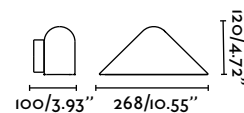



Wall Lamp

Ref.	75509		white blanco
	75510		grey gris
	75511		black negro
Bulb	1x E27 max 20W not incl. [LED 17454]		
Materials	Die Cast Aluminium + Translucent Polycarbonate Aluminio Inyectado + Policarbonato Translúcido		
V/Hz	100-240V / 50-60 Hz		
EEL	A++ to B		
Weight	0.7 kg / 1.54 lb		

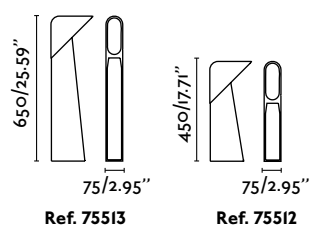

+ info



Ref. 75513

Ref. 75512

Beacon

Ref.	75512		black negro	HF
	75513		black negro	HF
Bulb	1x E27 max 20W not incl. [LED 17454]			
Materials	Die Cast Aluminium + Translucent Polycarbonate Aluminio Inyectado + Policarbonato Translúcido			
V/Hz	100-240V / 50-60 Hz			
EEL	A++ to B			
Weight	1.7-2.3 kg / 3.75-5.07 lb			

+ info



Ref. 75513

Ref. 75512

HF Until stock exhaustion
Hasta final de stock
Jusqu'à la fin de stock

Steps



Design: Estudi Ribaudf



Steps is a tubular composition that gives a growing sensation in the space. A set of upper and lower lights accentuates this feeling.



Wall Lamp

Ref.	75500		white blanco
	75501		dark grey gris oscuro
Bulb	2xGU10 max 35W not incl. [LED 17317]		
Materials	Die Cast Aluminium + Tempered Glass Aluminio Inyectado + Cristal Templado		
V/Hz	100-240V / 50-60 Hz		
EEL	A++ to E		
Weight	0.9 kg / 1.98 lb		

+ info   

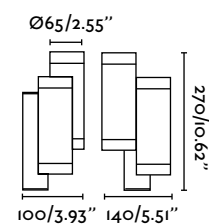
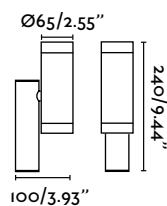

Wall Lamp



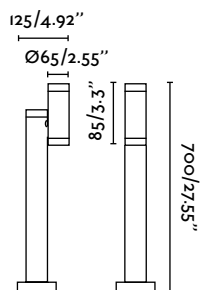

Ref.	75502		white blanco
	75503		dark grey gris oscuro
Bulb	4xGU10 max 35W not incl. [LED 17317]		
Materials	Die Cast Aluminium + Tempered Glass Aluminio Inyectado + Cristal Templado		
V/Hz	100-240V / 50-60 Hz		
EEL	A++ to E		
Weight	1.4 kg / 3.09 lb		

+ info   







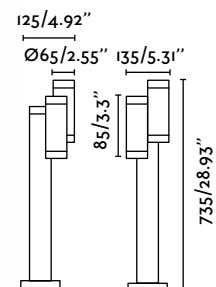

**Beacon**

Ref.	75504  white blanco	HF
	75505  dark grey gris oscuro	HF
Bulb	1xGU10 max 35W not incl. [LED 17317]	
Materials	Die Cast Aluminium + Tempered Glass Aluminio Inyectado + Cristal Templado	
V/Hz	100-240V / 50-60 Hz	
EEl	A++ to E	
Weight	2.11 kg / 4.65 lb	
+ info	  	

**Beacon**

Ref.	75506  white blanco	HF
	75507  dark grey gris oscuro	HF
Bulb	2xGU10 max 35W not incl. [LED 17317]	
Materials	Die Cast Aluminium + Tempered Glass Aluminio Inyectado + Cristal Templado	
V/Hz	100-240V / 50-60 Hz	
EEl	A++ to E	
Weight	2.61 kg / 5.75 lb	
+ info	  	

HF Until stock exhaustion
Hasta final de stock
Jusqu'à la fin de stock

Yak

Design: Àlex&Manel
Llusçà



Minimising
space and achieving
new unconventional
shapes through the use
of LED technology.

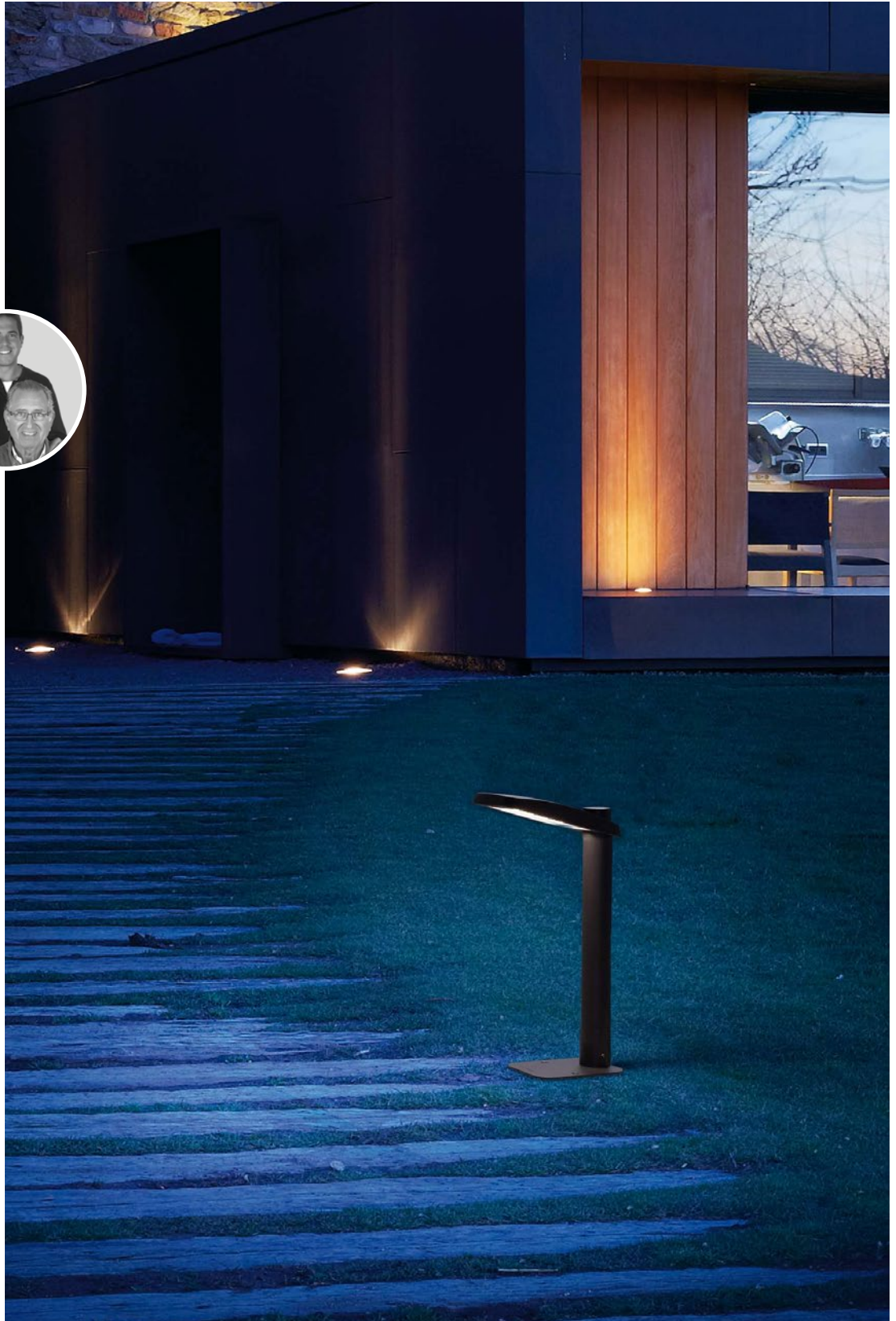

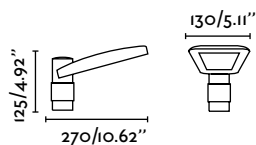

Wall Lamp

LED

Ref.	75106	 dark grey gris oscuro
Bulb	SMD LED 6W 4000K 630Lm incl.	
Materials	Die Cast Aluminium + Transparent Glass Aluminio Inyectado + Cristal Transparente	
V/Hz	220-240V / 50/60 Hz	
EEL	A++	
Weight	1.2 kg / 2.65 lb	
+ info	    	

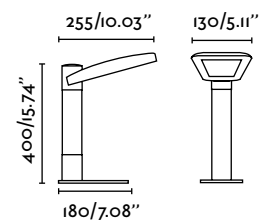

LED

Beacon		
Ref.	75108	 dark grey gris oscuro
Bulb	SMD LED 6W 4000K 630Lm incl.	
Materials	Die Cast Aluminium + Transparent Glass Aluminio Inyectado + Cristal Transparente	
V/Hz	220-240V / 50/60 Hz	
EEL	A++	
Weight	1.8 kg / 3.97 lb	
+ info	    	

Sentinel



Design: Estudi Ribaudf



Sentinel comes from the synthesis of form, the result provides us with a collection of soft shapes with real personality.



Wall Lamp

Ref.	75100		white blanco
	75101		dark grey gris oscuro
Bulb	1xE27 max 20W not incl. [LED 17453]		
Materials	Die Cast Aluminium + Transparent Glass Aluminio Inyectado + Cristal Transparente		
V/Hz	100-240V / 50-60 Hz		
EEL	A++ to B		
Weight	1.1 kg / 2.43 lb		

+ info

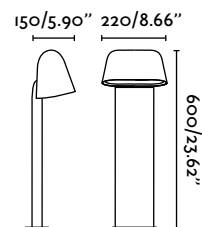
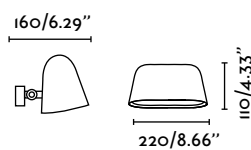

Beacon

Ref.	75102		white blanco
	75103		dark grey gris oscuro
Bulb	1xE27 max 20W not incl. [LED 17453]		
Materials	Die Cast Aluminium + Transparent Glass Aluminio Inyectado + Cristal Transparente		
V/Hz	100-240V / 50-60 Hz		
EEL	A++ to B		
Weight	2.64 kg / 5.82 lb		

+ info



Klamp

Design: Àlex&Manel
Llusçà



Aesthetics and functionality come together in this series of contemporary and stylish lines. The beacons are available with a light sensor to provide the user with maximum comfort and safety.



Wall Lamp

Ref.	74407  dark grey gris oscuro
Bulb	1xGU10 max 35W not incl. [LED 17317]
Materials	Die Cast Aluminium + Transparent Glass Aluminio Inyectado + Cristal Transparente
V/Hz	100-240V / 50-60 Hz
EEl	A++ to E
Weight	0.65 kg / 1.43 lb

+ info    

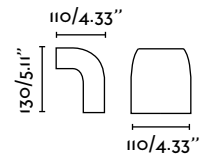

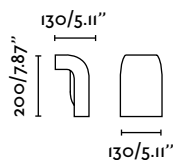

Wall Lamp

Ref. 74409  dark grey
gris oscuro

Bulb 1xE27 max 15W not incl. [LED 17454]

Materials Die Cast Aluminium + Opal Polycarbonate
Aluminio Inyectado + Policarbonato Opal

V/Hz 100-240V / 50-60 Hz

EEL A++ to B

Weight 1.1 kg / 2.43 lb

+ info

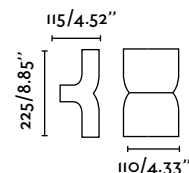

Wall Lamp

Ref. 74408  dark grey
gris oscuro

Bulb 2xGU10 max 35W not incl. [LED 17317]

Materials Die Cast Aluminium + Transparent Glass
Aluminio Inyectado + Cristal Transparente

V/Hz 100-240V / 50-60 Hz

EEL A++ to B

Weight 0.97 kg / 2.14 lb

+ info

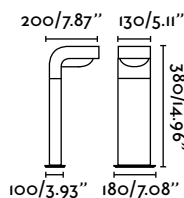

Beacon

Ref. 74410  dark grey
gris oscuro

Bulb 1xE27 15W not incl. [LED 17454]

Materials Die Cast Aluminium + Opal Polycarbonate
Aluminio Inyectado + Policarbonato Opal

V/Hz 100-240V / 50-60 Hz

EEL A++ to B

Weight 2.1 kg / 4.63 lb

+ info

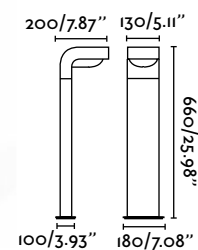

Beacon

Ref. 74411  dark grey
gris oscuro

Bulb 1xE27 15W not incl. [LED 17454]

Materials Die Cast Aluminium + Opal Polycarbonate
Aluminio Inyectado + Policarbonato Opal

V/Hz 100-240V / 50-60 Hz

EEL A++ to B

Weight 2.84 kg / 6.26 lb

+ info



Newport

Design: Estudi Ribaudí





Newport is a lamp that evokes a return to authentic and intimate objects. It transports us to the romanticism of the beginning of the century ... A timeless appearance.

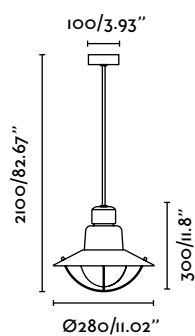



Pendant Lamp

Ref.	71154		white blanco
	71155		green verde
	71156		bordeaux burdeos

Bulb 1xE27 max 60W not incl. [LED 17453]

Materials Metal + Opal Glass
Metal + Cristal Opal

V/Hz 100-240V / 50-60 Hz

EEL A++ to E

Weight 1.7 kg / 3.75 lb

+ info   

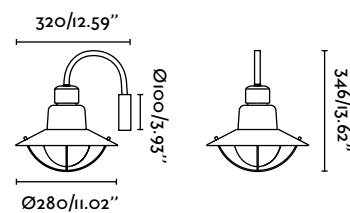

Wall Lamp

Ref.	71151		white blanco
	71152		green verde
	71153		bordeaux burdeos

Bulb 1xE27 max 60W not incl. [LED 17453]

Materials Metal + Opal Glass
Metal + Cristal Opal

V/Hz 100-240V / 50-60 Hz

EEL A++ to E

Weight 1.8 kg / 3.97 lb

+ info  





Sail

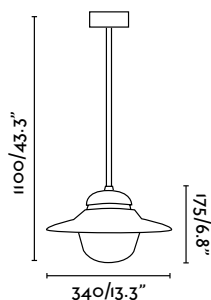



Pendant Lamp

Ref.	71358		white blanco	HF
	71359		black negro	HF

Bulb	1xE27 max 60W not incl. [LED 17453]
Materials	Die Cast Aluminium + Opal Glass Aluminio Inyectado + Cristal Opal
V/Hz	100-240V / 50-60 Hz
EEL	A++ to E
Weight	1.22 kg / 2.69 lb

+ info  

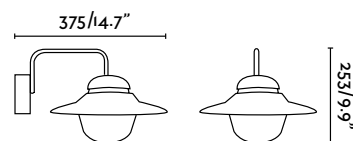

Wall Lamp

Ref.	71357		black negro	HF
-------------	--------------	---	----------------	----

Bulb	1xE27 max 60W not incl. [LED 17453]
Materials	Die Cast Aluminium + Opal Glass Aluminio Inyectado + Cristal Opal
V/Hz	100-240V / 50-60 Hz
EEL	A++ to E
Weight	1.22 kg / 2.69 lb

+ info  

HF Until stock exhaustion
Hasta final de stock
Jusqu'à la fin de stock





Moon

Design: Faro Team

It is the search for the essence of light, and simplicity in shape. A full moon that floods everything around it with light.



Wall Lamp

Ref.	74432+74437	 dark grey gris oscuro	TOTAL PRICE
Bulb	1xE27 20W not incl. [LED 17056]		
Materials	Die Cast Aluminium + Opal PMMA Aluminio Inyectado + PMMA Opal		
V/Hz	100-240V / 50-60 Hz		
EEL	A++ to B		
Weight	0.6 kg / 1.32 lb		
+ info	  		

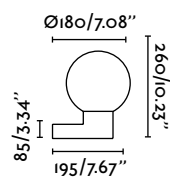

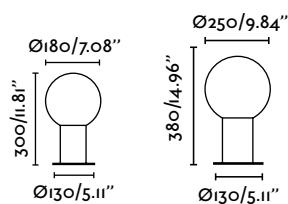

Ref. 74433+74437 Ref. 74433+74438

Post Lamp	
Ref.	74433+74437 ● dark grey gris oscuro TOTAL PRICE
	74433+74438 ● dark grey gris oscuro TOTAL PRICE
Bulb	1x E27 20W not incl. [LED 17056]
Materials	Die Cast Aluminium + Opal PMMA Aluminio Inyectado + PMMA Opal
V/Hz	100-240V / 50-60 Hz
EEL	A++ to B
Weight	0.6 kg / 1.32 lb

+ info

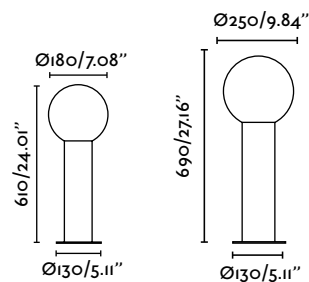

Ref. 74434+74437 Ref. 74434+74438

Beacon	
Ref.	74434+74437 ● dark grey gris oscuro TOTAL PRICE
	74434+74438 ● dark grey gris oscuro TOTAL PRICE
Bulb	1x E27 20W not incl. [LED 17056]
Materials	Die Cast Aluminium + Opal PMMA Aluminio Inyectado + PMMA Opal
V/Hz	100-240V / 50-60 Hz
EEL	A++ to B
Weight	1.3 kg / 2.87 lb



+ info



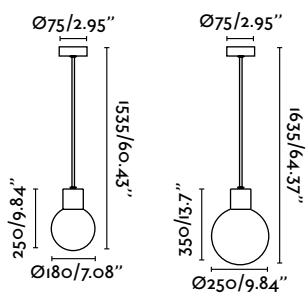



Pendant Lamp

Ref.	74427+74437		dark grey gris oscuro	TOTAL PRICE
	74427+74438		dark grey gris oscuro	TOTAL PRICE

Bulb	1xE27 max 20W not incl. [LED 17056]
Materials	Die Cast Aluminium + Opal PMMA Aluminio Inyectado + PMMA Opal
V/Hz	100-240V / 50-60 Hz
EEL	A++ to B
Weight	0.99-1.49 kg / 2.18-3.28 lb

+ info

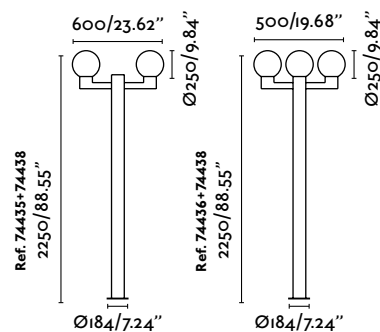

Pole Lamp

Ref.	74435+74438		dark grey gris oscuro	TOTAL PRICE
	(1 ud.) (2 ud.)			

Bulb 2xE27 max 20W not incl. [LED 17056]

Ref.	74436+74438		dark grey gris oscuro	TOTAL PRICE
	(1 ud.) (3 ud.)			

Bulb 3xE27 max 20W not incl. [LED 17056]

Materials Die Cast Aluminium + Opal PMMA
Aluminio Inyectado + PMMA Opal

V/Hz 100-240V / 50-60 Hz

EEL A++ to B

Weight 8.8-10.10 kg / 19.40-22.27 lb

+ info



Blub's

Design: Estudi Ribaudf

Blub's is like a bubble of air emanating from the earth. Its shapes are softened by the light and complement the space in a simple and ordered way.



Wall Lamp

Ref.	74432+74430	 dark grey gris oscuro	<small>TOTAL PRICE</small>
Bulb	1 x E27 20W not incl. [LED 17056]		
Materials	Die Cast Aluminium + Opal PMMA Aluminio Inyectado + PMMA Opal		
V/Hz	100-240V / 50-60 Hz		
EEL	A++ to B		
Weight	0.6 kg / 1.32 lb		

+ info

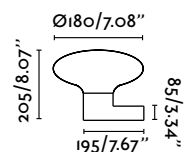

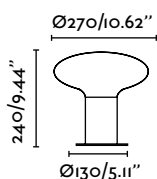



Post Lamp

Ref.	74433+74430	 dark grey gris oscuro	TOTAL PRICE
Bulb	1xE27 20W not incl. [LED 17056]		
Materials	Die Cast Aluminium + Opal PMMA Aluminio Inyectado + PMMA Opal		
V/Hz	100-240V / 50-60 Hz		
EEL	A++ to B		
Weight	0.8 kg / 1.76 lb		

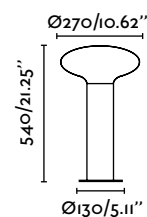
+ info



Beacon

Ref.	74434+74430	 dark grey gris oscuro	TOTAL PRICE
Bulb	1xE27 20W not incl. [LED 17056]		
Materials	Die Cast Aluminium + Opal PMMA Aluminio Inyectado + PMMA Opal		
V/Hz	100-240V / 50-60 Hz		
EEL	A++ to B		
Weight	1.2 kg / 2.65 lb		

+ info





Pole Lamp		
Ref.	74435+74430 (1 ud.) (2 ud.)	dark grey / gris oscuro
Bulb	2xE27 max 20W not incl. [LED 17056]	
Materials	Die Cast Aluminium + Opal PMMA / Aluminio Inyectado + PMMA Opal	
V/Hz	100-240V / 50-60 Hz	
EEL	A++ to B	
Weight	10.1 kg / 22.27 lb	

TOTAL PRICE

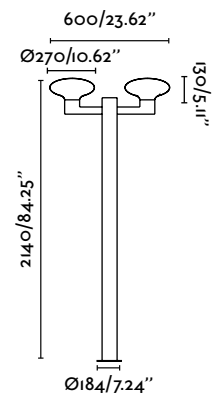

+ info   

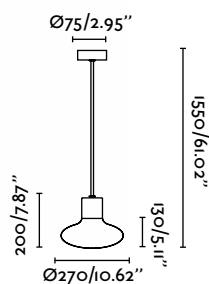
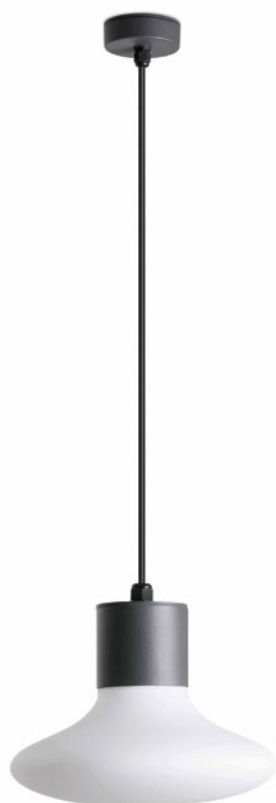

Pendant Lamp

Ref.	74427+74430	 dark grey gris oscuro	TOTAL PRICE
Bulb	1xE27 max 20W not incl. [LED 17056]		
Materials	Die Cast Aluminium + Opal PMMA Aluminio Inyectado + PMMA Opal		
V/Hz	100-240V / 50-60 Hz		
EEL	A++ to B		
Weight	0.59 kg / 1.30 lb		

+ info

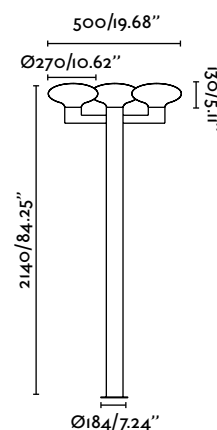

Pole Lamp

Ref.	74436+74430	 dark grey gris oscuro	TOTAL PRICE
	(1 ud.) (3 ud.)		
Bulb	3xE27 max 20W not incl. [LED 17056]		
Materials	Die Cast Aluminium + Opal PMMA Aluminio Inyectado + PMMA Opal		
V/Hz	100-240V / 50-60 Hz		
EEL	A++ to B		
Weight	10.1 kg / 22.27 lb		

+ info



Muffin

Design: Àlex&Manel
Llusçà



A series with
a fun and informal
die cast aluminium de-
sign with a pleated white
opal pmma shade.



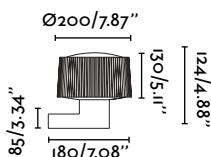



Wall Lamp

Ref.	74432+74429	 dark grey gris oscuro	TOTAL PRICE
Bulb	1xE27 max 20W not incl. [LED 17056]		
Materials	Die Cast Aluminium + Opal PMMA Aluminio Inyectado + PMMA Opal		
V/Hz	100-240V / 50-60 Hz		
EEl	A++ to B		
Weight	0.6 kg / 1.32 lb		

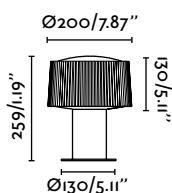
+ info



Post Lamp

Ref.	74433+74429	 dark grey gris oscuro	TOTAL PRICE
Bulb	1xE27 max 20W not incl. [LED 17056]		
Materials	Die Cast Aluminium + Opal PMMA Aluminio Inyectado + PMMA Opal		
V/Hz	100-240V / 50-60 Hz		
EEl	A++ to B		
Weight	0.6 kg / 1.32 lb		

+ info

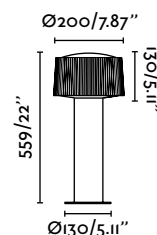

Beacon

Ref.	74434+74429	 dark grey gris oscuro	TOTAL PRICE
Bulb	1xE27 max 20W not incl. [LED 17056]		
Materials	Die Cast Aluminium + Opal PMMA Aluminio Inyectado + PMMA Opal		
V/Hz	100-240V / 50-60 Hz		
EEl	A++ to B		
Weight	1.3 kg / 2.87 lb		

+ info





**Pole
Lamp**

Ref.	74435+74429 (1 ud.) (2 ud.)	 dark grey gris oscuro	TOTAL PRICE
Bulb	2xE27 max 20W not incl. [LED 17056]		
Materials	Die Cast Aluminium + Opal PMMA Aluminio Inyectado + PMMA Opal		
V/Hz	100-240V / 50-60 Hz		
EEL	A++ to B		
Weight	8.3 kg / 18.30 lb		

+ info   

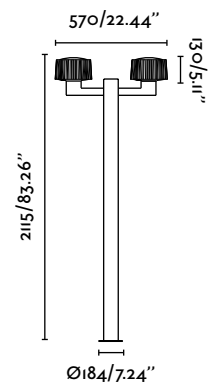

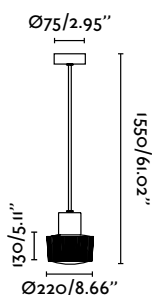



Pendant Lamp

Ref.	74427+74429	 dark grey gris oscuro	TOTAL PRICE
Bulb	1xE27 max 20W not incl. [LED 17056]		
Materials	Die Cast Aluminium + Opal PMMA Aluminio Inyectado + PMMA Opal		
V/Hz	100-240V / 50-60 Hz		
EEL	A++ to B		
Weight	1.3 kg / 2.87 lb		

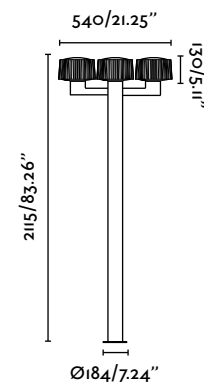
+ info



Pole Lamp

Ref.	74436+74429	 dark grey gris oscuro	TOTAL PRICE
	(1 ud.) (3 ud.)		
Bulb	3xE27 max 20W not incl. [LED 17056]		
Materials	Die Cast Aluminium + Opal PMMA Aluminio Inyectado + PMMA Opal		
V/Hz	100-240V / 50-60 Hz		
EEL	A++ to B		
Weight	10.4 kg / 22.93 lb		

+ info



Mistu

Design: Faro Team

Pleasant design for a highly versatile series. A polymethacrylate (pmma) diffuser provides excellent, perfectly proportioned light.



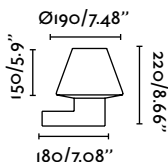



Wall Lamp

Ref.	74432+74428		dark grey gris oscuro	TOTAL PRICE
Bulb	1xE27 20W not incl. [LED 17056]			
Materials	Die Cast Aluminium + Opal PMMA Aluminio Inyectado + PMMA Opal			
V/Hz	100-240V / 50-60 Hz			
EEL	A++ to B			
Weight	0.6 kg / 1.32 lb			

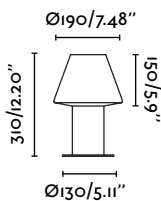
+ info



Post Lamp

Ref.	74433+74428		dark grey gris oscuro	TOTAL PRICE
Bulb	1xE27 20W not incl. [LED 17056]			
Materials	Die Cast Aluminium + Opal PMMA Aluminio Inyectado + PMMA Opal			
V/Hz	100-240V / 50-60 Hz			
EEL	A++ to B			
Weight	0.56 kg / 1.23 lb			

+ info

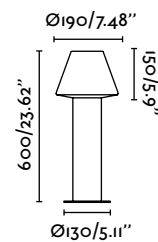

Beacon

Ref.	74434+74428		dark grey gris oscuro	TOTAL PRICE
Bulb	1xE27 20W not incl. [LED 17056]			
Materials	Die Cast Aluminium + Opal PMMA Aluminio Inyectado + PMMA Opal			
V/Hz	100-240V / 50-60 Hz			
EEL	A++ to B			
Weight	0.6 kg / 1.32 lb			

+ info







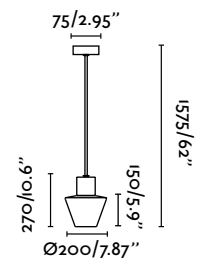

**Pendant
Lamp**

Ref.	74427+74428	 dark grey gris oscuro
Bulb	1xE27 max 20W not incl. [LED 17056]	
Materials	Die Cast Aluminium + Opal PMMA Aluminio Inyectado + PMMA Opal	
V/Hz	100-240V / 50-60 Hz	
EEl	A++ to B	
Weight	0.6 kg / 1.32 lb	

TOTAL
PRICE

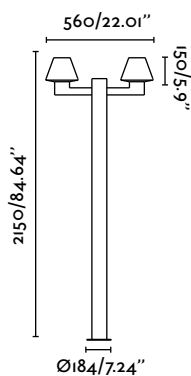

+ info    

**Pole
Lamp**

Ref. **74435+74428**  dark grey
(1 ud.) (2 ud.) gris oscuro

TOTAL PRICE

Bulb 2xE27 20W not incl. [LED 17056]

Materials Die Cast Aluminium + Opal PMMA
Aluminio Inyectado + PMMA Opal

V/Hz 100-240V / 50-60 Hz

EEL A++ to B

Weight 8.3 kg / 18.30 lb

+ info

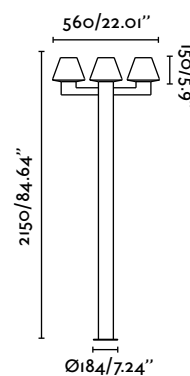
**Pole
Lamp**

Ref. **74436+74428**  dark grey
(1 ud.) (3 ud.) gris oscuro

TOTAL PRICE

Bulb 3xE27 20W not incl. [LED 17056]

Materials Die Cast Aluminium + Opal PMMA
Aluminio Inyectado + PMMA Opal

V/Hz 100-240V / 50-60 Hz

EEL A++ to B

Weight 9 kg / 19.84 lb

+ info



Cross

Design: Àlex&Manel
Llusçà



Made of die cast aluminium and polycarbonate, the cross series is ideal for both contemporary and classic environments.



Portable

IP65

Ref.	74353	 dark grey gris oscuro
Bulb	1xE27 max 20W not incl. [LED 17453]	
Materials	Die Cast Aluminium + Opal Polycarbonate Aluminio Inyectado + Policarbonato Opal	
V/Hz	100-240V / 50-60 Hz	
EEL	A++ to E	
Weight	0.57 kg / 1.26 lb	

HF

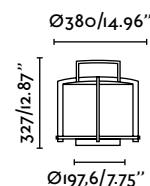

+ info



HF Until stock exhaustion
Hasta final de stock
Jusqu'à la fin de stock

Ceiling Lamp

Ref.	74355  dark grey gris oscuro
Bulb	2xE27 max 20W not incl. [LED I7452]
Materials	Die Cast Aluminium + Opal Polycarbonate Aluminio Inyectado + Policarbonato Opal
V/Hz	100-240V / 50-60 Hz
EEL	A++ to B
Weight	2.2 kg / 4.85 lb

+ info

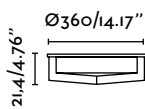

HF

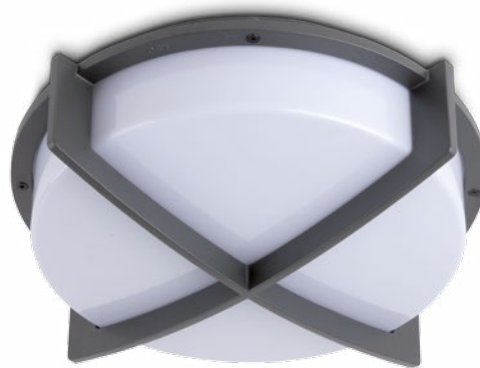

Wall Lamp

Ref.	74350  dark grey gris oscuro
Bulb	1xE27 max 20W not incl. [LED I7452]
Materials	Die Cast Aluminium + Opal Polycarbonate Aluminio Inyectado + Policarbonato Opal
V/Hz	100-240V / 50-60 Hz
EEL	A++ to E
Weight	1.8 kg / 3.97 lb

+ info

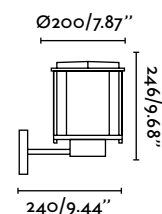

IP65

HF

Post Lamp

Ref.	74351  dark grey gris oscuro
Bulb	1xE27 max 20W not incl. [LED I7452]
Materials	Die Cast Aluminium + Opal Polycarbonate Aluminio Inyectado + Policarbonato Opal
V/Hz	100-240V / 50-60 Hz
EEL	A++ to B
Weight	1.55 kg / 3.42 lb

+ info

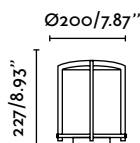

IP65

HF





HF Until stock exhaustion
Hasta final de stock
Jusqu'à la fin de stock



Beacon

IP65

Ref.	74356		dark grey gris oscuro
	74357		dark grey gris oscuro

HF

HF

Bulb 1xE27 max 20W not incl. [LED 17452]

Materials Die Cast Aluminium + Opal Polycarbonate
Aluminio Inyectado + Policarbonato Opal

V/Hz 100-240V / 50-60 Hz

EEL A++ to E

Weight 3 kg / 6.61 lb

+ info

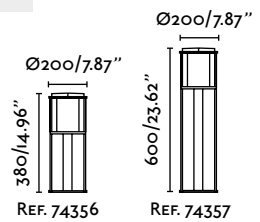

HF Until stock exhaustion
Hasta final de stock
Jusqu'à la fin de stock

Pole Lamp

IP65

Ref.	74358 ● dark grey / gris oscuro
Bulb	PL2G II 55W 5000K incl. [I5925]
Materials	Die Cast Aluminium + Opal Polycarbonate / Aluminio Inyectado + Policarbonato Opal
V/Hz	220-240V / 50-60 Hz
EEl	A to B
Weight	14.5 kg / 31.97 lb

+ info



IP65

BALLAST ✓

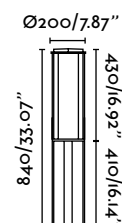

IP65

Beacon PL

Ref.	74359 ● dark grey / gris oscuro	HF
Bulb	PL2G II 36W 6400W incl. [I5923]	
Materials	Die Cast Aluminium + Opal Polycarbonate / Aluminio Inyectado + Policarbonato Opal	
V/Hz	220-240V / 50-60 Hz	
EEl	A to B	
Weight	5.97 kg / 13.16 lb	

+ info



IP65

BALLAST ✓

Beacon LED

IP65

LED

Ref.	74349 ● dark grey / gris oscuro	HF
Bulb	LED STRIPS 24W 4000K 2500Lm incl.	
Materials	Die Cast Aluminium + Opal Polycarbonate / Aluminio Inyectado + Policarbonato Opal	
V/Hz	220-240V / 50-60 Hz	
EEl	A++ to A	
Weight	5.97 kg / 13.16 lb	

+ info



IP65

DRIVER ✓

HF Until stock exhaustion
Hasta final de stock
Jusqu'à la fin de stock



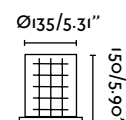

Antipolution Light P

Ref. **74369**  chrome cromado

HF

Materials Steel + Transparent Polycarbonate
Acero + Policarbonato Transparente

Weight 0.8 kg / 1.76 lb

+ info



For / Para 74350,73351,74356, 74357, 74366

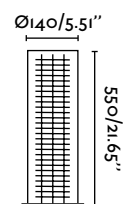

Antipolution Light G

Ref. **74370**  chrome cromado

HF

Materials Steel + Transparent Polycarbonate
Acero + Policarbonato Transparente

Weight 2.4 kg / 5.29 lb

+ info



For / Para 74358

HF Until stock exhaustion
Hasta final de stock
Jusqu'à la fin de stock





Boletus

Design: Àlex&Manel
Llusçà



With a modern design and rounded lines, boletus provides indirect and nuanced light thanks to its opal polycarbonate diffuser and the slot in the top of the shade.



Pole Lamp	
Ref.	74395  dark grey / gris oscuro
Bulb	3xE27 20W not incl. [LED 17452]
Materials	Die Cast Aluminium + Opal Polycarbonate / Aluminio Inyectado + Policarbonato Opal
V/Hz	100-240V / 50-60 Hz
EEL	A++ to B
Weight	9.5 kg / 20.94 lb
+ info	   

HF

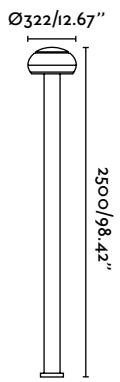

**Wall Lamp**

Ref. 74391 ● dark grey
gris oscuro

Bulb 1xE27 20W not incl. [LED 17452]

Materials Die Cast Aluminium + Opal Polycarbonate
Aluminio Inyectado + Policarbonato Opal

V/Hz 100-240V / 50-60 Hz

EEL A++ to B

Weight 1.6 kg / 3.53 lb

+ info    

HF

**Post Lamp**

Ref. 74392 ● dark grey
gris oscuro

Bulb 1xE27 20W not incl. [LED 17452]

Materials Die Cast Aluminium + Opal Polycarbonate
Aluminio Inyectado + Policarbonato Opal

V/Hz 100-240V / 50-60 Hz

EEL A++ to B

Weight 1.6 kg / 3.53 lb

+ info    

HF

**Post Lamp**

Ref. 74393 ● dark grey
gris oscuro

Bulb 3xE27 20W not incl. [LED 17452]

Materials Die Cast Aluminium + Opal Polycarbonate
Aluminio Inyectado + Policarbonato Opal

V/Hz 100-240V / 50-60 Hz

EEL A++ to B

Weight 3.1 kg / 6.83 lb

+ info    

HF

**Beacon**

Ref. 74394 ● dark grey
gris oscuro

Bulb 1xE27 20W not incl. [LED 17452]

Materials Die Cast Aluminium + Opal Polycarbonate
Aluminio Inyectado + Policarbonato Opal

V/Hz 100-240V / 50-60 Hz

EEL A++ to B

Weight 2.16 kg / 4.76 lb

+ info    

HF

HF Until stock exhaustion
Hasta final de stock
Jusqu'à la fin de stock

Alp

Family of stylized lines that works by LED technology. It is available in dark gray.



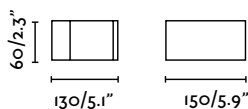

Wall Lamp

LED

Ref.	74450 ● dark grey gris oscuro
Bulb	SMD LED 8W 3000K 220Lm CRI>80 incl.
Materials	Metal + Opal Polycarbonate Metal + Policarbonato Opal
V/Hz	110-240V / 50-60 Hz
EEL	A+
Weight	0.54 kg / 1.19 lb

+ info

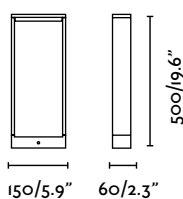
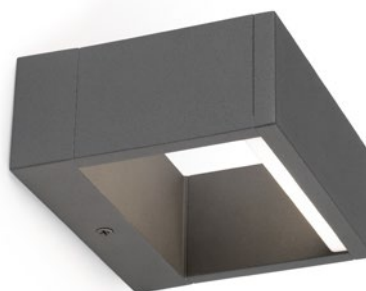

LED

Beacon

Ref.	74451 ● dark grey gris oscuro
Bulb	SMD LED 8W 3000K 220Lm CRI>80 incl.
Materials	Metal + Opal Polycarbonate Metal + Policarbonato Opal
V/Hz	110-240V / 50-60 Hz
EEL	A+
Weight	1.14 kg / 2.51 lb

+ info

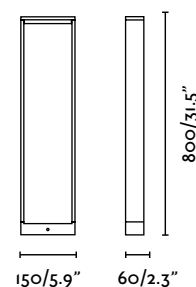

LED

Beacon

Ref.	74452 ● dark grey gris oscuro
Bulb	SMD LED 8W 3000K 220Lm CRI>80 incl.
Materials	Metal + Opal Polycarbonate Metal + Policarbonato Opal
V/Hz	110-240V / 50-60 Hz
EEL	A+
Weight	1.51 kg / 3.33 lb

+ info



Das

Das is a trendy set for outdoor lighting, which incorporates LED technology and comprises one wall lamp and two beacons.



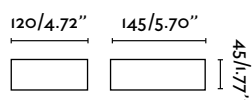

Wall Lamp		LED
Ref.	75518	● dark grey gris oscuro
Bulb	COB LED 5W 3000K 140Lm CRI>80 incl.	
Materials	Die Cast Aluminium + Transparent Glass Aluminio Inyectado + Cristal Transparente	
V/Hz	110-240V / 50-60 Hz	
EEL	A++ to A	
Weight	0.7 kg / 1.54 lb	
+ info		

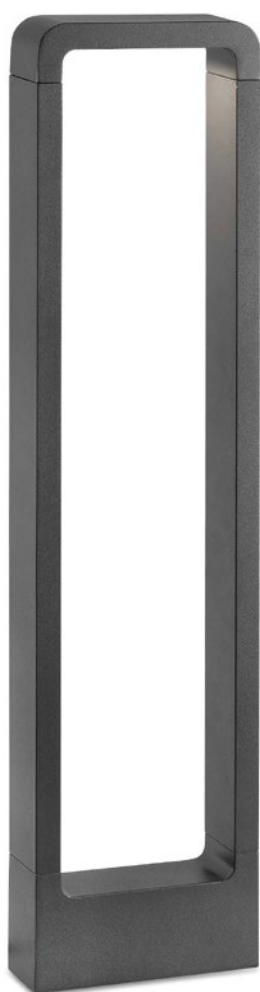
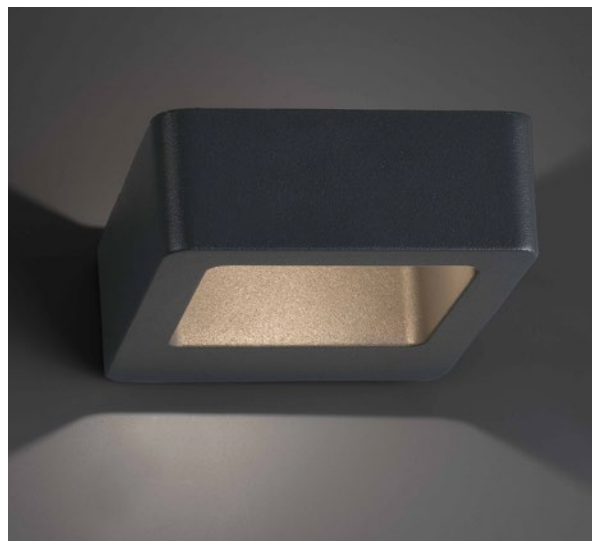

Ref. 75520



Ref. 75519

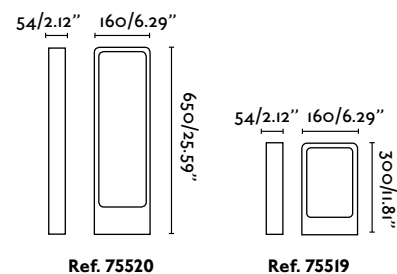

Beacon		LED
Ref.	75519	● dark grey gris oscuro
	75520	● dark grey gris oscuro
Bulb	COB LED 5W 3000K 140Lm CRI>80 incl.	
Materials	Die Cast Aluminium + Transparent Glass Aluminio Inyectado + Cristal Transparente	
V/Hz	110-240V / 50-60 Hz	
EEL	A++ to A	
Weight	2.3-3.31 kg / 15.07-7.29 lb	
+ info		

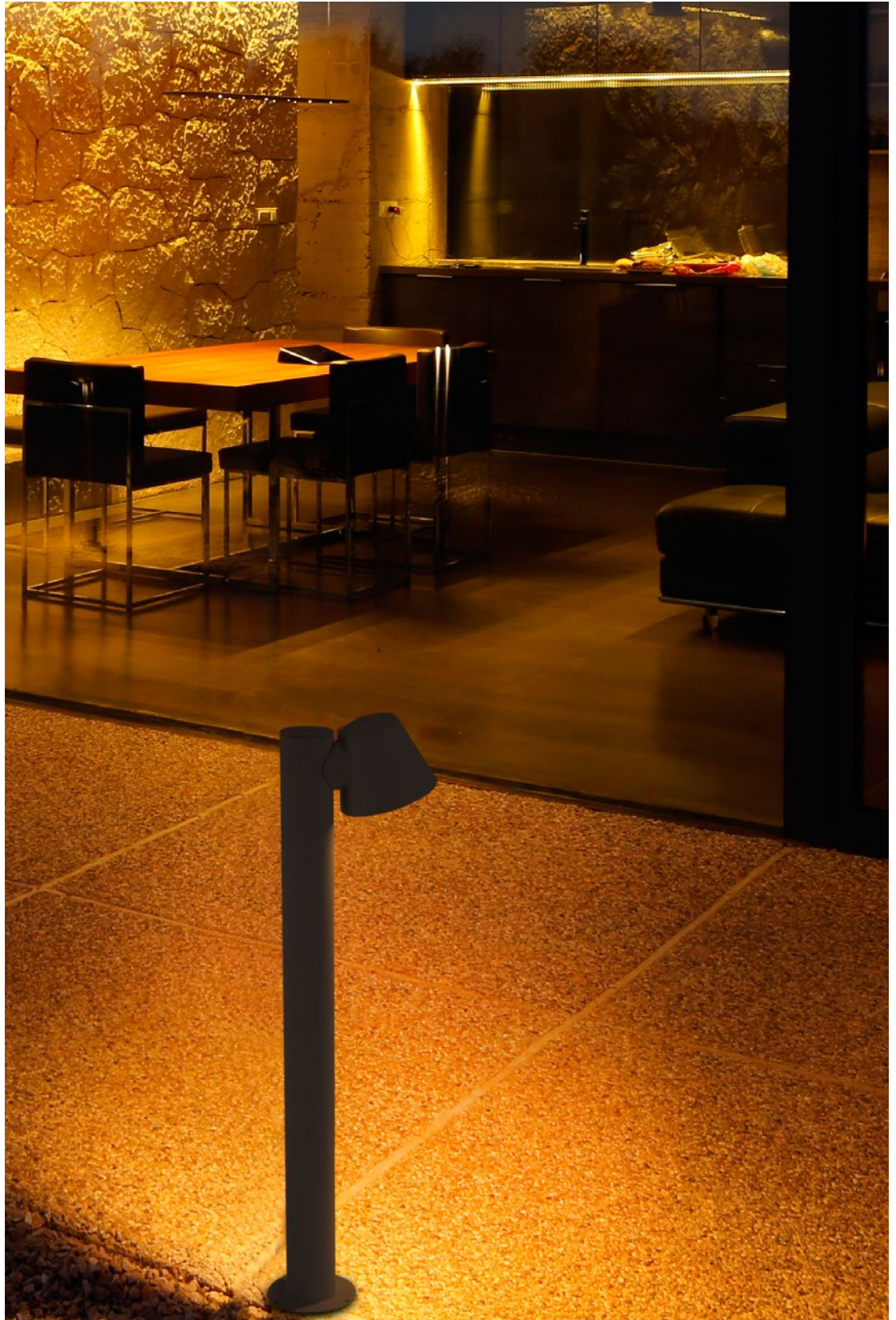

Gina

Family composed of a wall light and beacon. They are made of injected aluminum with a transparent glass diffuser.

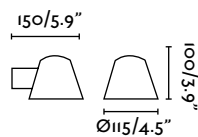

Wall Lamp



Ref.	71363		dark grey gris oscuro	[LED 17324]
	71366		white blanco	[LED 17316]
	71367		black negro	[LED 17324]

Bulb 1xGU10 35W not incl.

Materials Die Cast Aluminium + Transparent Glass
Aluminio Inyectado + Cristal Transparente

V/Hz 100-240V / 50-60 Hz

EEL A++ to E

Weight 0.44 kg / 0.97 lb

+ info

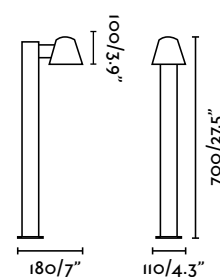

Beacon

Ref.	71352		dark grey gris oscuro
-------------	--------------	--	--------------------------

Bulb 1xGU10 35W not incl. [LED 17324]

Materials Die Cast Aluminium + Transparent Glass
Aluminio Inyectado + Cristal Transparente

V/Hz 100-240V / 50-60 Hz

EEL A++ to E

Weight 1.49 kg / 3.28 lb

+ info



Giza

Family composed of a wall light, post lamp and beacon. It works by LED technology and it is available in dark gray.



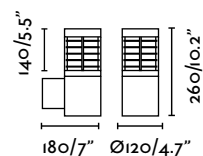

Wall Lamp	LED
Ref.	70766 ● dark grey / gris oscuro
Bulb	COB LED 15W 3000K 500Lm CRI>80 incl.
Materials	Die Cast Aluminium + Transparent Polycarbonate + Aluminium Aluminio Inyectado + Policarbonato Transparente + Aluminium
V/Hz	100-240V / 50-60 Hz
EEL	A
Weight	1.97 kg / 4.34 lb

+ info

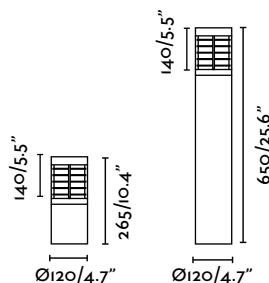

Post Lamp
Ref. 70767

Beacon
Ref. 70768

Post Lamp / Beacon	LED
Ref.	70767 ● dark grey / gris oscuro
	70768 ● dark grey / gris oscuro
Bulb	COB LED 15W 3000K 500Lm CRI>80 incl.
Materials	Die Cast Aluminium + Transparent Polycarbonate + Aluminium Aluminio Inyectado + Policarbonato Transparente + Aluminium
V/Hz	100-240V / 50-60 Hz
EEL	A
Weight	1.7-2.68 kg / 3.75-5.91 lb

+ info



Ref. 70767



Ref. 70768

Saga

Family composed by wall lamp and beacon that works through LED technology. It is made of aluminum with an opal polycarbonate diffuser.

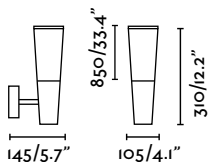

Wall Lamp

LED

Ref.	75526	● dark grey gris oscuro
Bulb	SMD LED 9W 4000K 392Lm CRI>80 incl.	
Materials	Aluminium + Opal Polycarbonate Aluminio + Policarbonato Opal	
V/Hz	100-240V / 50-60 Hz	
EEL	A++ to A	
Weight	0.88 kg / 1.94 lb	

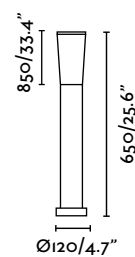
 + info   

Beacon

LED

Ref.	75527	● dark grey gris oscuro
Bulb	SMD LED 9W 4000K 392Lm CRI>80 incl.	
Materials	Aluminium + Opal Polycarbonate Aluminio + Policarbonato Opal	
V/Hz	100-240V / 50-60 Hz	
EEL	A++ to A	
Weight	1.34 kg / 2.95 lb	

 + info   

Rounder

Outdoor family made of injected aluminum that works by LED technology. It consists of a wall light and a beacon in dark grey.

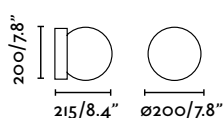

Wall Lamp

LED

Ref.	72400 ● dark grey gris oscuro
Bulb	SMD LED 8W 3000K 434Lm CRI>80 incl.
Materials	Die Cast Aluminium + Opal Glass Aluminio Inyectado + Cristal Opal
V/Hz	220-240V / 50-60 Hz
EEL	A
Weight	1.04 kg / 2.29 lb

+ info



IP44

DRIVER ✓

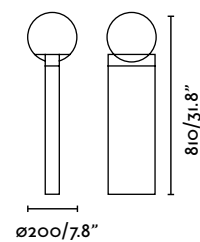
Beacon

LED

Ref.	72401 ● dark grey gris oscuro
Bulb	SMD LED 8W 3000K 434Lm CRI>80 incl.
Materials	Die Cast Aluminium + Opal Glass Aluminio Inyectado + Cristal Opal
V/Hz	220-240V / 50-60 Hz
EEL	A
Weight	3.64 kg / 8.02 lb

+ info



IP44

DRIVER ✓

Ellen

Ellen is an outdoor family composed of a wall light and a hanging light. This is modern style series with LED and it is made of injected aluminum.



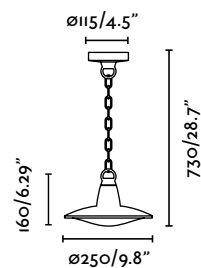

**Pendant
Lamp**

LED

Ref.	72403	 dark grey gris oscuro
Bulb	SMD LED 8W 3000K 546Lm CRI>80 incl.	
Materials	Die Cast Aluminium + Opal Polycarbonate Aluminio Inyectado + Policarbonato Opal	
V/Hz	220-240V / 50-60 Hz	
EEL	A+	
Weight	1.08 kg / 2.38 lb	

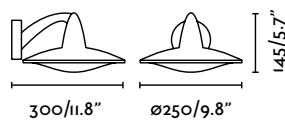
+ info

**Wall
Lamp**

LED

Ref.	72402	 dark grey gris oscuro
Bulb	SMD LED 8W 3000K 546Lm CRI>80 incl.	
Materials	Die Cast Aluminium + Opal Polycarbonate Aluminio Inyectado + Policarbonato Opal	
V/Hz	220-240V / 50-60 Hz	
EEL	A+	
Weight	1.13 kg / 2.49 lb	



+ info

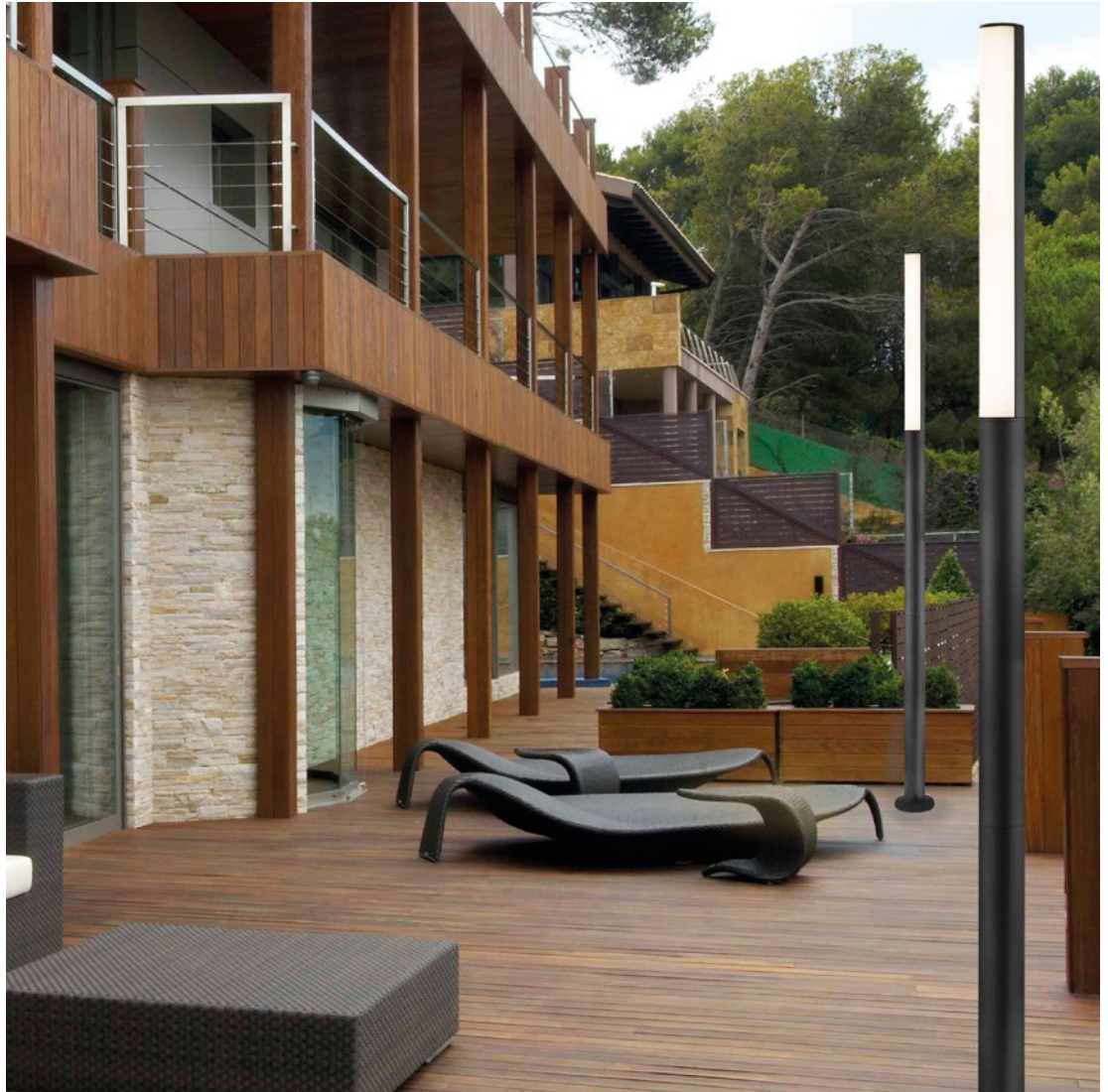

Beret

Beret is a trendy and simple set for outdoor lighting, which incorporates LED technology and comprises two beacon lamps and one lamp post.



Pole Lamp		LED
Ref.	75524	dark grey gris oscuro
Bulb	SMD LED 16W 4000K 625Lm CRI>80 incl.	
Materials	Aluminium + Opal PMMA Aluminio + PMMA Opal	
V/Hz	220-240V / 50-60 Hz	
EEL	A++ to A	
Weight	3.15 kg / 6.94 lb	
+ info		IP54 DRIVER 

Ø65/2.55"

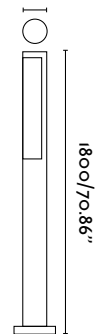

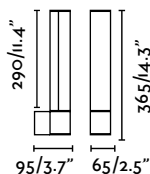

Wall Lamp

LED

Ref.	75525	dark grey gris oscuro
Bulb	SMD LED 8W 3000K 350Lm CRI>80 incl.	
Materials	Aluminium + Opal PMMA Aluminio + PMMA Opal	
V/Hz	220-240V / 50-60 Hz	
EEL	A	
Weight	0.85 kg / 1.87 lb	

+ info   

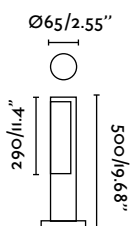

Beacon

LED

Ref.	75522	dark grey gris oscuro
Bulb	SMD LED 8W 4000K 350Lm CRI>80 incl.	
Materials	Aluminium + Opal PMMA Aluminio + PMMA Opal	
V/Hz	220-240V / 50-60 Hz	
EEL	A++ to A	
Weight	0.98 kg / 2.16 lb	

+ info   

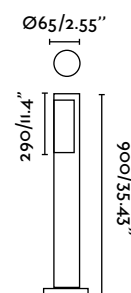

Beacon

LED

Ref.	75523	dark grey gris oscuro
Bulb	SMD LED 8W 4000K 350Lm CRI>80 incl.	
Materials	Aluminium + Opal PMMA Aluminio + PMMA Opal	
V/Hz	220-240V / 50-60 Hz	
EEL	A++ to A	
Weight	1.86 kg / 4.10 lb	

+ info   

Neo

Neo is a set for outdoor lighting made from die cast aluminium with a PMMA opal diffuser.



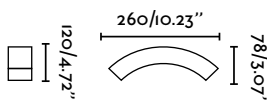

Wall Lamp

LED

Ref.	70629	● dark grey gris oscuro
Bulb	SMD LED 5W 4000K 810Lm CRI>80 incl.	
Materials	Die Cast Aluminium + Opal PMMA Aluminio Inyectado + PMMA Opal	
V/Hz	220-240V / 50-60 Hz	
EEL	A	
Weight	0.8 kg / 1.76 lb	

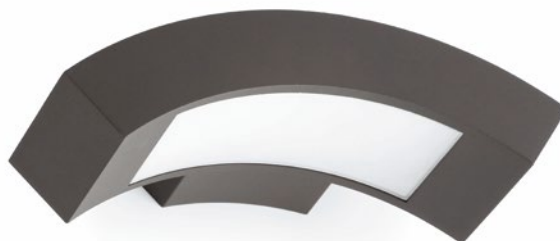
+ info



Ref. 70630

Ref. 70631

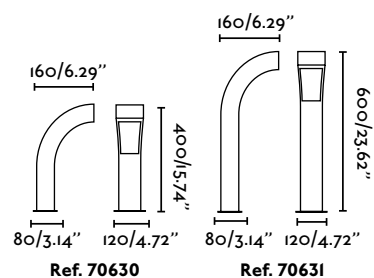

Ref. 70630

Ref. 70631

Beacon

LED

Ref.	70630	● dark grey gris oscuro
	70631	● dark grey gris oscuro
Bulb	SMD LED 5W 4000K 810Lm CRI>80 incl.	
Materials	Die Cast Aluminium + Opal PMMA Aluminio Inyectado + PMMA Opal	
V/Hz	220-240V / 50-60 Hz	
EEL	A	
Weight	1.3 kg / 2.87 lb	

+ info





Wilma



Wilma is a modern set for outdoor lighting made from aluminium with a translucent PC diffuser.





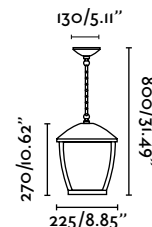

Pendant Lamp	LARGE
Ref.	75002 ● dark grey / gris oscuro
Bulb	1xE27 max 100W not incl. [LED 17453]
Materials	Die Cast Aluminium + Translucent Polycarbonate / Aluminio Inyectado + Policarbonato Translúcido
V/Hz	100-240V / 50-60 Hz
EEL	A++ to E
Weight	2.09 kg / 4.61 lb
+ info	 



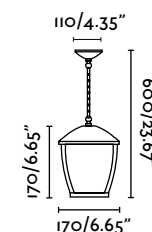

Pendant Lamp	SMALL
Ref.	74996 ● dark grey / gris oscuro
Bulb	1xE27 IIW not incl. [LED 17453]
Materials	Die Cast Aluminium + Translucent Polycarbonate / Aluminio Inyectado + Policarbonato Translúcido
V/Hz	100-240V / 50-60 Hz
EEL	A++ to B
Weight	1.3 kg / 2.87 lb
+ info	  



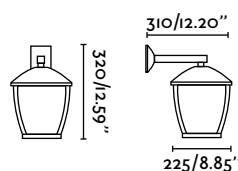

Wall Lamp	LARGE
Ref.	75000 ● dark grey / gris oscuro
Bulb	1xE27 max 100W not incl. [LED 17453]
Materials	Die Cast Aluminium + Translucent Polycarbonate / Aluminio Inyectado + Policarbonato Translúcido
V/Hz	100-240V / 50-60 Hz
EEL	A++ to E
Weight	2.14 kg / 4.72 lb
+ info	 



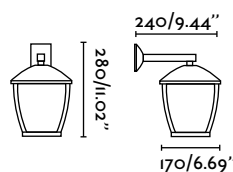



Wall Lamp	SMALL
Ref.	74998 ● dark grey / gris oscuro
Bulb	1xE27 IIW not incl. [LED 17453]
Materials	Die Cast Aluminium + Translucent Polycarbonate / Aluminio Inyectado + Policarbonato Translúcido
V/Hz	100-240V / 50-60 Hz
EEL	A++ to B
Weight	1.3 kg / 2.87 lb
+ info	  



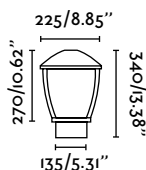





Post Lamp	LARGE
Ref.	75001  dark grey gris oscuro
Bulb	1xE27 max 100W not incl. [LED 17453]
Materials	Die Cast Aluminium + Translucent Polycarbonate Aluminio Inyectado + Policarbonato Translúcido
V/Hz	100-240V / 50-60 Hz
EEL	A++ to E
Weight	2.7 kg / 5.95 lb
+ info	 

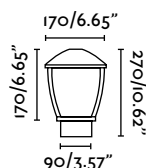





Post Lamp	SMALL
Ref.	74997  dark grey gris oscuro
Bulb	1xE27 11W not incl. [LED 17453]
Materials	Die Cast Aluminium + Translucent Polycarbonate Aluminio Inyectado + Policarbonato Translúcido
V/Hz	100-240V / 50-60 Hz
EEL	A++ to B
Weight	1.5 kg / 3.31 lb
+ info	  

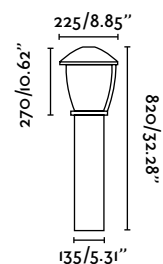

Beacon	LARGE
Ref.	75003  dark grey gris oscuro
Bulb	1xE27 max 100W not incl. [LED 17453]
Materials	Die Cast Aluminium + Translucent Polycarbonate Aluminio Inyectado + Policarbonato Translúcido
V/Hz	100-240V / 50-60 Hz
EEL	A++ to E
Weight	4.7 kg / 10.36 lb
+ info	 



Beacon	SMALL
Ref.	74999  dark grey gris oscuro
Bulb	1xE27 11W not incl. [LED 17453]
Materials	Die Cast Aluminium + Translucent Polycarbonate Aluminio Inyectado + Policarbonato Translúcido
V/Hz	100-240V / 50-60 Hz
EEL	A++ to B
Weight	2.1 kg / 4.63 lb
+ info	  

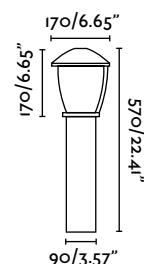

Long

Long is a modern set for outdoor lighting, comprising two beacon lamps and one wall lamp.



Wall Lamp

Ref.	75515	 dark grey gris oscuro
Bulb	1xE27 max 18W not incl. [LED 17454]	
Materials	Die Cast Aluminium + Translucent Glass Aluminio Inyectado + Cristal Translúcido	
V/Hz	100-240V / 50-60 Hz	
EEL	A++ to B	
Weight	1.18 kg / 2.60 lb	

+ info   

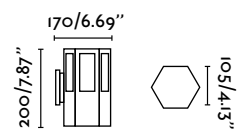

Post Lamp

Ref.	75514  dark grey gris oscuro
Bulb	1xE27 max 18W not incl. [LED 17454]
Materials	Die Cast Aluminium + Translucent Glass Aluminio Inyectado + Cristal Translúcido
V/Hz	100-240V / 50-60 Hz
EEL	A++ to B
Weight	0.82 kg / 1.81 lb

+ info

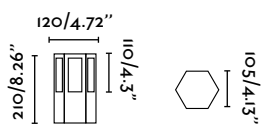
**Beacon**

Ref.	75516  dark grey gris oscuro
Bulb	1xE27 max 18W not incl. [LED 17454]
Materials	Die Cast Aluminium + Translucent Glass Aluminio Inyectado + Cristal Translúcido
V/Hz	100-240V / 50-60 Hz
EEL	A++ to B
Weight	2.35 kg / 5.18 lb

+ info

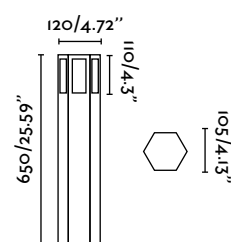



Cartago

Cartago is a set for outdoor lighting made from aluminium die casting with a polycarbonate opal diffuser.

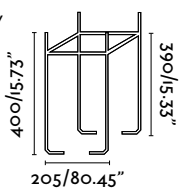

Accessory
Accesorio



R 7R I43 

Pole Lamp

Ref.	73256  dark grey gris oscuro
Bulb	3xT5 28W not incl. [I5833]
Materials	Die Cast Aluminium + Opal Polycarbonate Aluminio Inyectado + Policarbonato Opal
V/Hz	220-240V / 50 Hz
Weight	19.2 kg / 42.33 lb

+ info

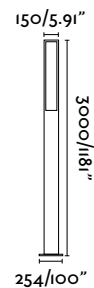

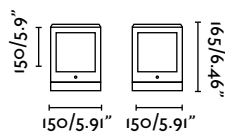



Post Lamp

Ref.	73254  dark grey gris oscuro
Bulb	1xE27 15W not incl. [LED 17453]
Materials	Die Cast Aluminium + Opal Polycarbonate Aluminio Inyectado + Policarbonato Opal
V/Hz	100-240V / 50-60 Hz
EEL	A++ to B
Weight	1.46 kg / 3.22 lb

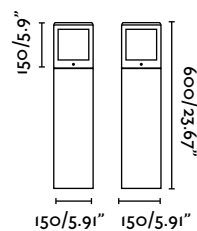
+ info



Beacon

Ref.	73255  dark grey gris oscuro
Bulb	1xE27 15W not incl. [LED 17453]
Materials	Die Cast Aluminium + Opal Polycarbonate Aluminio Inyectado + Policarbonato Opal
V/Hz	100-240V / 50-60 Hz
EEL	A++ to B
Weight	3.6 kg / 7.94 lb

+ info



Tarraco

Tarraco is a set for outdoor lighting made from aluminium die casting with a polycarbonate opal diffuser.



Wall Lamp

Ref.	73260  grey gris
Bulb	1xE27 15W not incl. [LED 17454]
Materials	Die Cast Aluminium + Opal Polycarbonate Aluminio Inyectado + Policarbonato Opal
V/Hz	100-240V / 50-60 Hz
EEI	A++ to B
Weight	0.69 kg / 1.52 lb

+ info

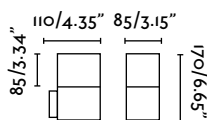

Beacon

Ref.	73261  grey gris
Bulb	1xE27 15W not incl. [LED 17454]
Materials	Die Cast Aluminium + Opal Polycarbonate Aluminio Inyectado + Policarbonato Opal
V/Hz	100-240V / 50-60 Hz
EEI	A++ to B
Weight	1.4 kg / 3.09 lb

+ info

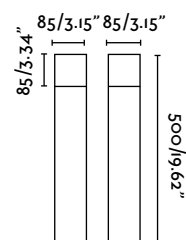

Onze

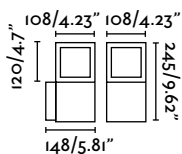

ONZE**Wall Lamp**

Ref.	70760  dark grey gris oscuro
Bulb	1xE27 20W not incl. [LED 17452]
Materials	Die Cast Aluminium + Opal Polycarbonate Aluminio Inyectado + Policarbonato Opal
V/Hz	100-240V / 50-60 Hz
EEL	A++ to B
Weight	1.6 kg / 3.53 lb

+ info

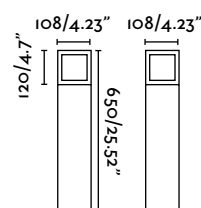
**ONZE****Beacon**

Ref.	70761  dark grey gris oscuro
Bulb	1xE27 20W not incl. [LED 17452]
Materials	Die Cast Aluminium + Opal Polycarbonate Aluminio Inyectado + Policarbonato Opal
V/Hz	100-240V / 50-60 Hz
EEL	A++ to B
Weight	3.1 kg / 6.83 lb

+ info



Sol



Pole Lamp	
Ref.	74390 ● black negro
Bulb	3xE27 max 60W not incl. [LED 17453]
Materials	Die Cast Aluminium + Opal Glass Aluminio Inyectado + Cristal Opal
V/Hz	100-240V / 50-60 Hz
EEL	A++ to E
Weight	11.9 kg / 26.24 lb
+ info	⏚ IP44

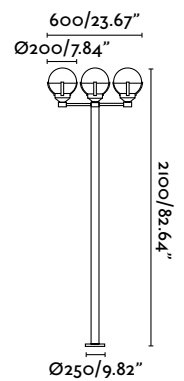

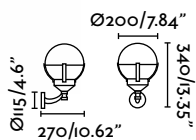

Wall Lamp

Ref.	74387	 black negro
Bulb	1xE27 max 60W not incl. [LED 17453]	
Materials	Die Cast Aluminium + Opal Glass Aluminio Inyectado + Cristal Opal	
V/Hz	100-240V / 50-60 Hz	
EEL	A++ to E	
Weight	1.9 kg / 4.19 lb	

+ info

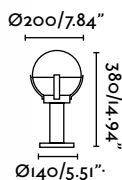

Post Lamp

Ref.	74388	 black negro
Bulb	1xE27 max 60W not incl. [LED 17453]	
Materials	Die Cast Aluminium + Opal Glass Aluminio Inyectado + Cristal Opal	
V/Hz	100-240V / 50-60 Hz	
EEL	A++ to E	
Weight	2.06 kg / 4.54 lb	

+ info

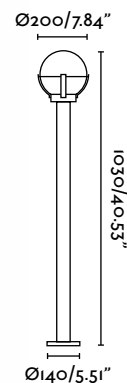

Beacon

Ref.	74389	 black negro
Bulb	1xE27 max 60W not incl. [LED 17453]	
Materials	Die Cast Aluminium + Opal Glass Aluminio Inyectado + Cristal Opal	
V/Hz	100-240V / 50-60 Hz	
EEL	A++ to E	
Weight	3.2 kg / 7.05 lb	

+ info



Mitra



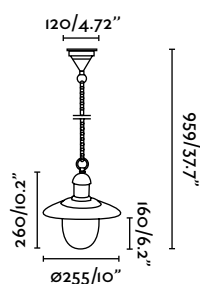

Pendant Lamp

Ref.	71145	 brushed brown marrón cepillado
Bulb	1xE27 60W not incl. [LED 17453]	
Materials	Metal + Aluminium + Bubble Glass Metal + Aluminio + Cristal Burbuja	
V/Hz	100-240V / 50-60 Hz	
EEL	A++ to E	
Weight	1.6 kg / 3.53 lb	

+ info  

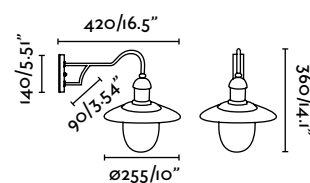

Wall Lamp

Ref.	71146	 brushed brown marrón cepillado
Bulb	1xE27 60W not incl. [LED 17453]	
Materials	Metal + Aluminium + Bubble Glass Metal + Aluminio + Cristal Burbuja	
V/Hz	100-240V / 50-60 Hz	
EEL	A++ to E	
Weight	1.7 kg / 3.75 lb	

+ info  

Estoril



Pendant Lamp-g

Ref.	71143  rust brown marrón óxido
Bulb	1xE27 max 60W not incl. [LED 17453]
Materials	Metal + Bubble Glass Metal + Cristal Burbuja
V/Hz	100-240V / 50-60 Hz
EEL	A++ to E
Weight	1.77 kg / 3.90 lb

+ info  

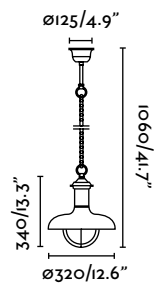

Pendant
Lamp-p

Ref.	71142	 rust brown marrón óxido
Bulb	1xE27 max 60W not incl. [LED 17453]	
Materials	Metal + Bubble Glass Metal + Cristal Burbuja	
V/Hz	100-240V / 50-60 Hz	
EEL	A++ to E	
Weight	1.6 kg / 3.53 lb	

+ info

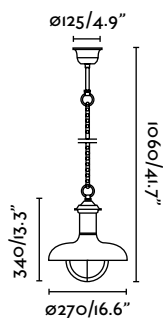
Wall
Lamp-p

Ref.	71140	 rust brown marrón óxido
Bulb	1xE27 max 60W not incl. [LED 17453]	
Materials	Metal + Bubble Glass Metal + Cristal Burbuja	
V/Hz	100-240V / 50-60 Hz	
EEL	A++ to E	
Weight	1.6 kg / 3.53 lb	

+ info

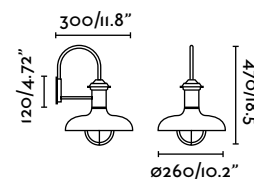
Wall
Lamp-g

Ref.	71141	 rust brown marrón óxido
Bulb	1xE27 max 60W not incl. [LED 17453]	
Materials	Metal + Bubble Glass Metal + Cristal Burbuja	
V/Hz	100-240V / 50-60 Hz	
EEL	A++ to E	
Weight	1.8 kg / 3.97 lb	

+ info

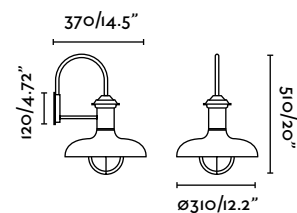

Paris



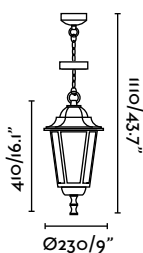

Pendant Lamp

BULB INCLUDED
BOMBILLA INCLUIDA

Ref.	73431 ● black negro
Bulb	1xE27 60W incl.
Materials	Die Cast Aluminium + Transparent Glass Aluminio Inyectado + Cristal Transparente
V/Hz	220-240V / 50-60 Hz
EEL	A+ to B
Weight	1.9 kg / 4.19 lb
+ info	 

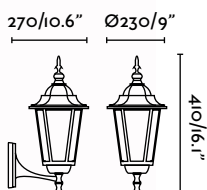

Wall Lamp

BULB INCLUDED
BOMBILLA INCLUIDA

Ref.	73432 ● black negro
Bulb	1xE27 60W incl.
Materials	Die Cast Aluminium + Transparent Glass Aluminio Inyectado + Cristal Transparente
V/Hz	220-240V / 50-60 Hz
EEL	A+ to B
Weight	1.9 kg / 4.19 lb
+ info	 

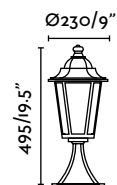

Post Lamp

BULB INCLUDED
BOMBILLA INCLUIDA

Ref.	73434 ● black negro
Bulb	1xE27 max 60W incl.
Materials	Die Cast Aluminium + Transparent Glass Aluminio Inyectado + Cristal Transparente
V/Hz	220-240V / 50-60 Hz
EEL	A+ to B
Weight	1.8 kg / 3.97 lb
+ info	 



Pole Lamp	BULB INCLUDED BOMBILLA INCLUIDA	
Ref.	73456	● black negro
Bulb	2xE27 max 100W incl.	
Materials	Die Cast Aluminium + Transparent Glass Aluminio Inyectado + Cristal Transparente	
V/Hz	220-240V / 50-60 Hz	
EEL	A+ to B	
Weight	11 kg / 24.25 lb	

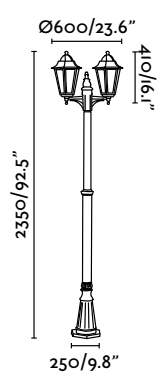

+ info  

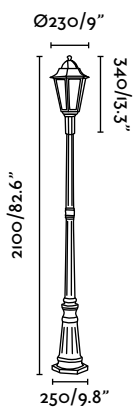

Pole Lamp

BULB INCLUDED
BOMBILLA INCLUIDA

Ref. **73436** ● black negro

Bulb 1xE27 max 100W incl.

Materials Die Cast Aluminium + Transparent Glass
Aluminio Inyectado + Cristal Transparente

V/Hz 220-240V / 50-60 Hz

EEL A+ to B

Weight 6.2 kg / 13.67 lb

+ info



IP43

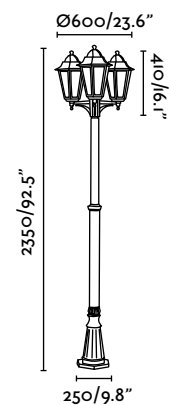

Post Lamp

BULB INCLUDED
BOMBILLA INCLUIDA

Ref. **73438** ● black negro

Bulb 3xE27 max 100W incl.

Materials Die Cast Aluminium + Transparent Glass
Aluminio Inyectado + Cristal Transparente

V/Hz 220-240V / 50-60 Hz

EEL A+ to B

Weight 11.89 kg / 26.21 lb

+ info



IP33

Náutica

Wall Lamp

Ref.	71128		rust brown marrón óxido
	SMALL		
Ref.	71129		rust brown marrón óxido
	LARGE		

Bulb 1xE27 11W not incl. [LED 17453]

Materials Metal + Bubble Glass
Metal + Cristal Burbuja

V/Hz 100-240V / 50-60 Hz

EEL A++ to B

Weight 1.2 kg / 2.65 lb

+ info

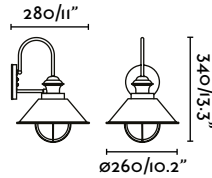

Ref. 71128

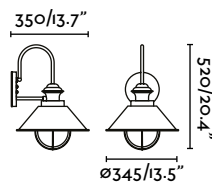

Ref. 71129



Wall Lamp

Ref.	71110		rust brown marrón óxido

Bulb 1xE27 11W not incl. [LED 17453]

Materials Metal + Bubble Glass
Metal + Cristal Burbuja

V/Hz 100-240V / 50-60 Hz

EEL A++ to B

Weight 1.3 kg / 2.87 lb

+ info

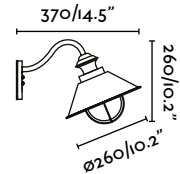

Wall Lamp

Ref.	71109		rust brown marrón óxido

Bulb 1xE27 11W not incl. [LED 17453]

Materials Metal + Bubble Glass
Metal + Cristal Burbuja

V/Hz 100-240V / 50-60 Hz

EEL A++ to B

Weight 2.53 kg / 5.58 lb

+ info

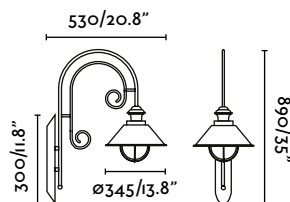

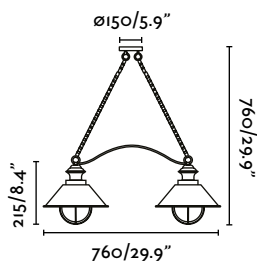

Pendant Lamp

Ref.	71113	 rust brown marrón óxido
Bulb	2xE27 IIW not incl. [LED 17453]	
Materials	Metal + Bubble Glass Metal + Cristal Burbuja	
V/Hz	100-240V / 50-60 Hz	
EEL	A++ to B	
Weight	3.1 kg / 6.83 lb	

+ info

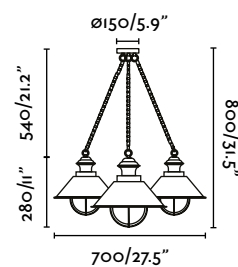

Pendant Lamp

Ref.	71114	 rust brown marrón óxido
Bulb	3xE27 IIW not incl. [LED 17453]	
Materials	Metal + Bubble Glass Metal + Cristal Burbuja	
V/Hz	100-240V / 50-60 Hz	
EEL	A++ to B	
Weight	4.84 kg / 10.67 lb	

+ info



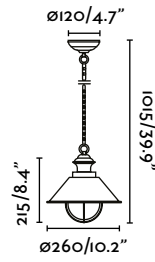



**Pendant
Lamp-p**

Ref.	71138  rust brown marrón óxido
Bulb	1 x E27 II W not incl. [LED 17453]
Materials	Metal + Bubble Glass Metal + Cristal Burbuja
V/Hz	100-240V / 50-60 Hz
EEL	A++ to B
Weight	1.2 kg / 2.65 lb

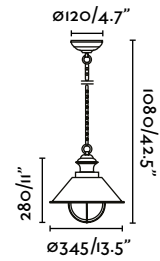
+ info   



**Pendant
Lamp-g**

Ref.	71139  rust brown marrón óxido
Bulb	1 x E27 II W not incl. [LED 17453]
Materials	Metal + Bubble Glass Metal + Cristal Burbuja
V/Hz	100-240V / 50-60 Hz
EEL	A++ to B
Weight	1.69 kg / 3.73 lb

+ info   

Pendant Lamp

Ref. 71112  rust brown
marrón óxido

Bulb 3xE27 II W not incl. [LED 17453]

Materials Metal + Bubble Glass
Metal + Cristal Burbuja

V/Hz 100-240V / 50-60 Hz

EEL A++ to B

Weight 4.2 kg / 9.26 lb

+ info

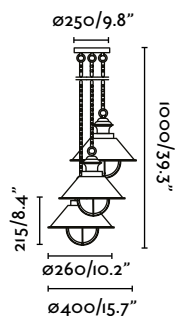

Pendant Lamp

Ref. 71111  rust brown
marrón óxido

Bulb 2xE27 II W not incl. [LED 17453]

Materials Metal + Bubble Glass
Metal + Cristal Burbuja

V/Hz 100-240V / 50-60 Hz

EEL A++ to B

Weight 2.98 kg / 6.57 lb

+ info

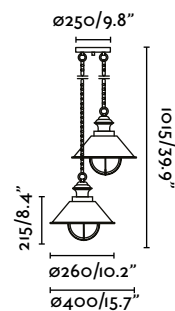



**Pole
Lamp**

Ref.	71118	 rust brown marrón óxido
Bulb	3xE27 11 W not incl. [LED 17453]	
Materials	Metal + Bubble Glass Metal + Cristal Burbuja	
V/Hz	100-240V / 50-60 Hz	
EEL	A++ to B	
Weight	16.1 kg / 35.49 lb	

+ info   

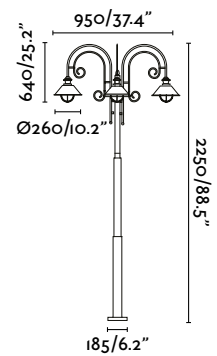

**Pole
Lamp**

Ref. 71116  rust brown
marrón óxido

Bulb 1xE27 II W not incl. [LED 17453]

Materials Metal + Bubble Glass
Metal + Cristal Burbuja

V/Hz 100-240V / 50-60 Hz

EEL A++ to B

Weight 11.86 kg / 26.15 lb

+ info

**Pole
Lamp**

Ref. 71117  rust brown
marrón óxido

Bulb 2xE27 II W not incl. [LED 17453]

Materials Metal + Bubble Glass
Metal + Cristal Burbuja

V/Hz 100-240V / 50-60 Hz

EEL A++ to B

Weight 16.26 kg / 35.85 lb

+ info



Agra G	143
Agra P	143
Aristo	145
Chandra	142
Jaipur	137
Mila <small>[new]</small>	137
Naya	141
Sete	138
Sora	139
Surat	139
Verno	145





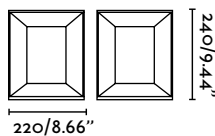

MILA [new]

Post Lamp

IP65 LED

Ref.	70771  dark grey / gris oscuro
Bulb	LED 18W 4000K 500Lm CRI>80 incl.
Materials	Die Cast Aluminium + Opal Glass / Aluminio Inyectado + Cristal Opal
V/Hz	220-240V / 50-60 Hz
EEL	A++ to A
Weight	3.6 kg / 7.94 lb

+ info  IP65 DRIVER 

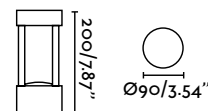

JAIPUR

Beacon

LED

Ref.	70758  dark grey / gris oscuro
Bulb	COB LED 6W 3000K 420Lm incl.
Materials	Die Cast Aluminium + Transparent Glass / Aluminio Inyectado + Cristal Transparente
V/Hz	100-240V / 50-60 Hz
EEL	A+
Weight	0.8 kg / 1.76 lb

+ info  IP54 DRIVER 



SETE

LED

Beacon

Ref.	7552I	 dark grey gris oscuro
Bulb	SMD LED 6W 3000K 155Lm incl.	
Materials	Die Cast Aluminium + Opal Polycarbonate Aluminio Inyectado + Policarbonato Opal	
V/Hz	100-240V / 50-60 Hz	
EEL	A++ to A	
Weight	1.7 kg / 3.75 lb	

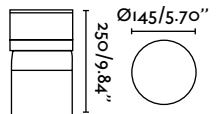

+ info



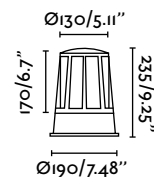

SURAT

Beacon

Ref.	72310	 dark grey gris oscuro
Bulb	1xE27 20W not incl. [LED 17453]	
Materials	Die Cast Aluminium + Striped Glass Aluminio Inyectado + Cristal Rallado	
V/Hz	100-240V / 50-60 Hz	
EEl	A++ to B	
Weight	2.7 kg / 5.95 lb	

+ info

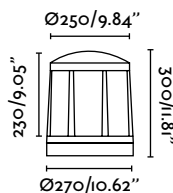

SORA

Beacon

Ref.	72299	 dark grey gris oscuro
Bulb	1xE27 max 26W not incl. [LED 17457]	
Materials	Die Cast Aluminium + Opal Polycarbonate Aluminio Inyectado + Policarbonato Opal	
V/Hz	100-240V / 50-60 Hz	
EEl	A++ to B	
Weight	3.08 kg / 6.79 lb	

+ info





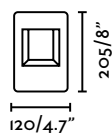

NAYA

Post Lamp

LED

Ref.	71198	 dark grey gris oscuro
Bulb	SMD LED 8W 3000K 120Lm incl.	
Materials	Aluminium + Opal Polycarbonate Aluminio + Policarbonato Opal	
V/Hz	100-240V / 50-60 Hz	
EEl	A	
Weight	1.22 kg / 2.69 lb	

+ info

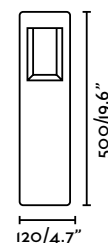

NAYA

Beacon

LED

Ref.	71199	 dark grey gris oscuro
Bulb	SMD LED 8W 3000K 120Lm incl.	
Materials	Aluminium + Opal Polycarbonate Aluminio + Policarbonato Opal	
V/Hz	100-240V / 50-60 Hz	
EEl	A	
Weight	2.24 kg / 4.94 lb	

+ info









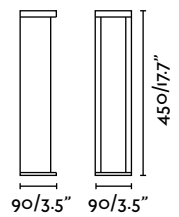

CHANDRA

LED

Beacon

Ref.	72298	 dark grey gris oscuro
Bulb	COB LED 7W 3000K 195Lm CRI>80 incl.	
Materials	Aluminium + Tempered Glass Aluminio + Cristal Templado	
V/Hz	100-240V / 50-60 Hz	
EEL	A++ to A	
Weight	1.64 kg / 3.62 lb	



+ info     

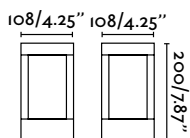

AGRA P

Beacon

LED

Ref.	70755		dark grey gris oscuro
	70756		rust brown marrón óxido
Bulb	COB LED 5W 3000K 420Lm incl.		
Materials	Die Cast Aluminium + Transparent Glass Aluminio Inyectado + Cristal Transparente		
V/Hz	100-240V / 50-60 Hz		
EEl	A+		
Weight	1.2 kg / 2.65 lb		

+ info



IP54

DRIVER

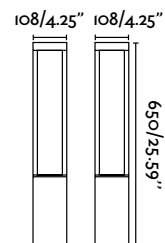

AGRA G

Beacon

LED

Ref.	70753		dark grey gris oscuro
	70754		rust brown marrón óxido
Bulb	COB LED 6W 3000K 290Lm incl.		
Materials	Die Cast Aluminium + Transparent Glass Aluminio Inyectado + Cristal Transparente		
V/Hz	100-240V / 50-60 Hz		
EEl	A+		
Weight	2.2 kg / 4.85 lb		

+ info



IP54

DRIVER





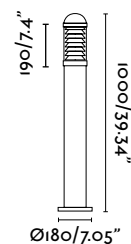

ARISTO

IP65

Beacon

Ref.	73196	 black negro
Bulb	1xG24d-3 26W not incl. [15905]	
Materials	Die Cast Aluminium + Transparent Polycarbonate Aluminio Inyectado + Policarbonato Transparente	
V/Hz	220-240V / 50-60 Hz	
EEL	A++ to B	
Weight	4.28 kg / 9.44 lb	

+ info



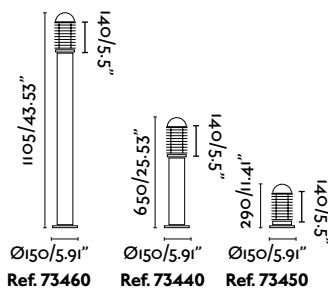

IP65

Magnetic Gear 



VERNO

Beacon

Ref.	73440	 black negro
	73450	 black negro
	73460	 black negro
Bulb	1xE27 max 60W not incl. [LED 17454]	
Materials	Die Cast Aluminium + Transparent Polycarbonate Aluminio Inyectado + Policarbonato Transparente	
V/Hz	100-240V / 50-60 Hz	
EEL	A++ to E	
Weight	1.5-2-2.60 kg / 3.31-4.40-5.73 lb	

+ info



IP44



Ref. 73460



Ref. 73440



Ref. 73450

More beacons



Alp
89



Beret
103



Bird
49



Blub'S
69



Boletus
87



Cartago
113



Cross
82



Das
91



Datna
47



Gina
93



Giza
95



Grow
31



Klamp
59



Long
111



Mistu
77



Moon
65



Muffin
73



Neo
105



Onze
117



Rounder
99



Saga
97



Sentinel
57



Shelby
35



Sol
119



Steps
53



Tarraco
115



Tau
43



Tram
37



Wilma
109



Yak
55

Aday <small>[new]</small>	161	Erio	195	Neftis	177	Terra	221
Amon	163	Estay	223	Negus	203	Tinia	175
Áncora	156	Fedon	202	Nisha	185	Toluca <small>[new]</small>	187
Argot	218	Fenes -1	199	Nono	222	Usagui <small>[new]</small>	187
Askot	225	Future	153	Noray	207	Vertice <small>[new]</small>	167
Baco	185	Grant	193	Num <small>[new]</small>	183	View	152
Blind	169	Half <small>[new]</small>	150	Olan <small>[new]</small>	168	Visnu	209
Bonn	203	Hepta	225	Olot <small>[new]</small>	211	Wally	219
Bracket <small>[new]</small>	186	Ina <small>[new]</small>	215	Óvalo	223	West	201
Cabo	207	Inari	184	Papo	175	Yen	216
Canon	171	Ion	177	Parma	219	Zoe <small>[new]</small>	183
Capri	175	Kamal	179	Path <small>[new]</small>	192		
Cela	205	Kami	176	Pistón	172		
Ceres	158	Keenan	189	Proa	155		
Coal	195	Kubick	200	Radha	165		
Cobo	172	Lace	169	Radio	225		
Code	154	Lacre	173	Rondo	224		
Crata	171	Latina	173	Rustic	209		
Cripta	220	Ling	169	Sor	199		
Dado	219	Marat	178	Suma	196		
Dakron	217	Mare	165	Sun <small>[new]</small>	167		
Dakyu	217	Mera <small>[new]</small>	215	Taima <small>[new]</small>	181		
Derby	221	Mirto	223	Tami	211		
Didot	173	Mol	197	Tane	172		
Dorval	205	Must <small>[new]</small>	191	Tasa	213		
Dragma	157	Naomi	185	Teba <small>[new]</small>	181		
Ele	162	Natron	197	Tejo	197		



Half [new]

Design: Nahtrang



Its clean lines
help us to be a
timeless piece. Half, easy
to install in all kinds of
contexts.



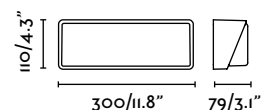

[new]

Wall Lamp

IP65 LED

Ref. **71536**  white
blanco

71537  dark grey
gris oscuro

Bulb SMD LED 20W 3000K | 350Lm CRI>80 incl.

Materials Die Cast Aluminium + Opal Glass
Aluminio Inyectado + Cristal Opal

V/Hz 100-240V / 50-60 Hz

EEL A

Weight 1.62 kg / 3.57 lb

+ info   

View

Design: Estudi Ribaudf

View is a wall lamp with futuristic shapes that perfectly combines innovation and reality. High resistance to atmospheric conditions.

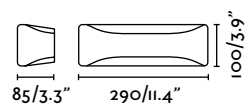

Wall Lamp + Wall Washer

Ref.	71519	 dark grey gris oscuro
Bulb	1xE27 max 15W not incl. [LED 17453]	
Materials	Polycarbonate + ABS Policarbonato + ABS	
V/Hz	100-240V / 50 Hz	
EEL	A++ to B	
Weight	0.44 kg / 0.97 lb	

+ info



Future

Design: Estudi Ribaudf

Futures is an outdoor fixture characterised by an attractive and decorative set of indirect lights. Its smooth, flat oblong shape blend into its surroundings.

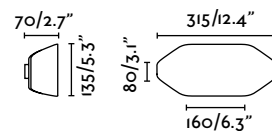

Wall Lamp + Wall Washer

Ref. **71516**  white
blanco

71517  dark grey
gris oscuro

Bulb 1 x E27 max 20W not incl. [LED 17452]

Materials Polycarbonate
Policarbonato

V/Hz 100-240V / 50-60 Hz

EEI A++ to B

Weight 0.6 kg / 1.32 lb

+ info



Code

Design: Estudi Ribaudf



Code is an eclipse of light, a path of concentric circles that accompany us almost unnoticed.

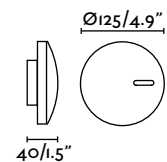
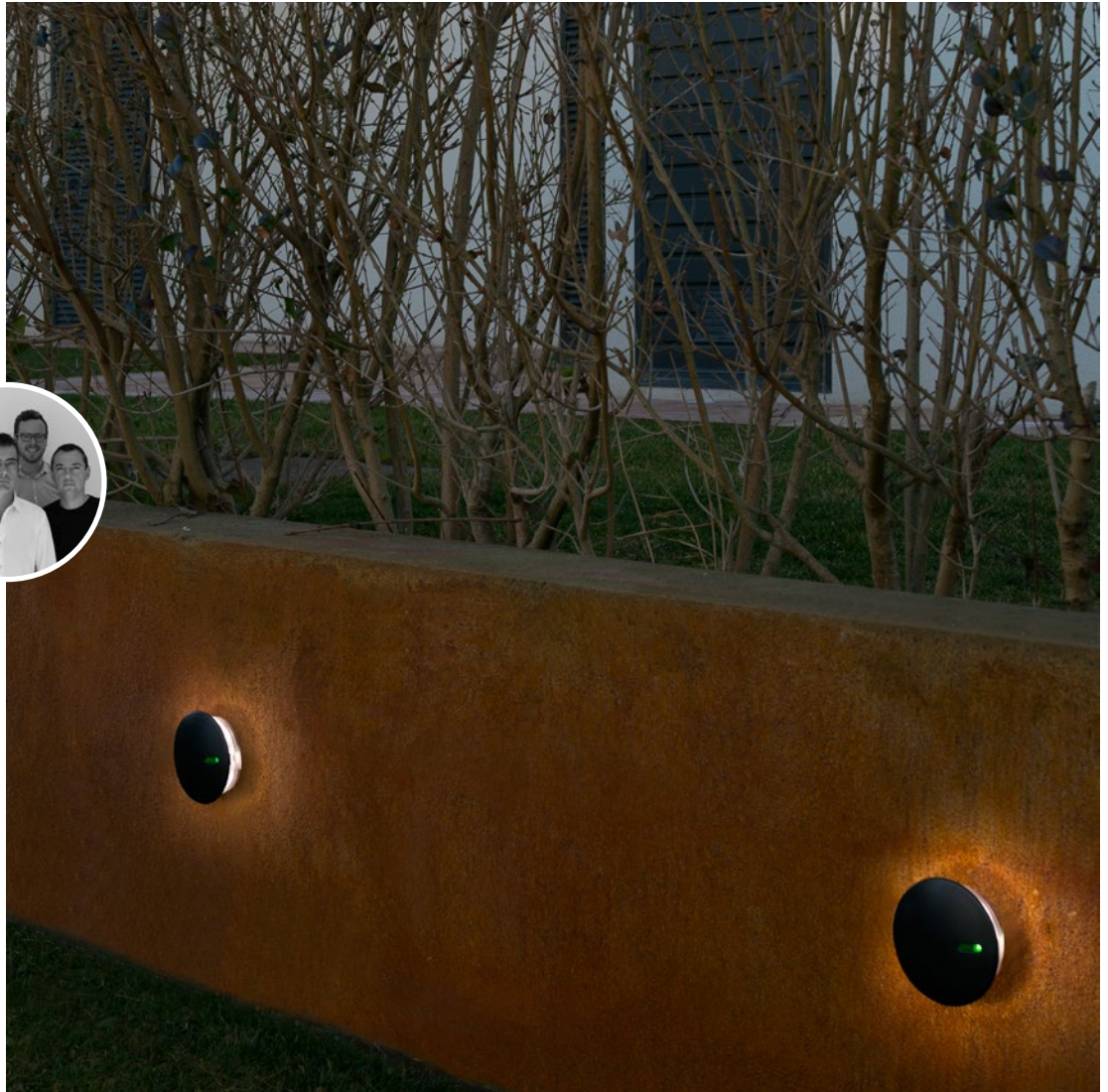

Wall Lamp

LED

Ref.	71526		white blanco	+
				3 stickers ✓
	71527		dark grey gris oscuro	+
Bulb	SMD LED 2W 4000K 150Lm incl.			
Materials	Polycarbonate Policarbonato			
V/Hz	220-240V / 50-60 Hz			
EEL	A++ to A			
Weight	0.2 kg / 0.44 lb			

+ info

Proa

Design: Àlex&Manel
Lluscà



A modern, compact design in die casting aluminium for a wall fixture intended for signposting. Also available in led version.

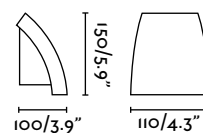
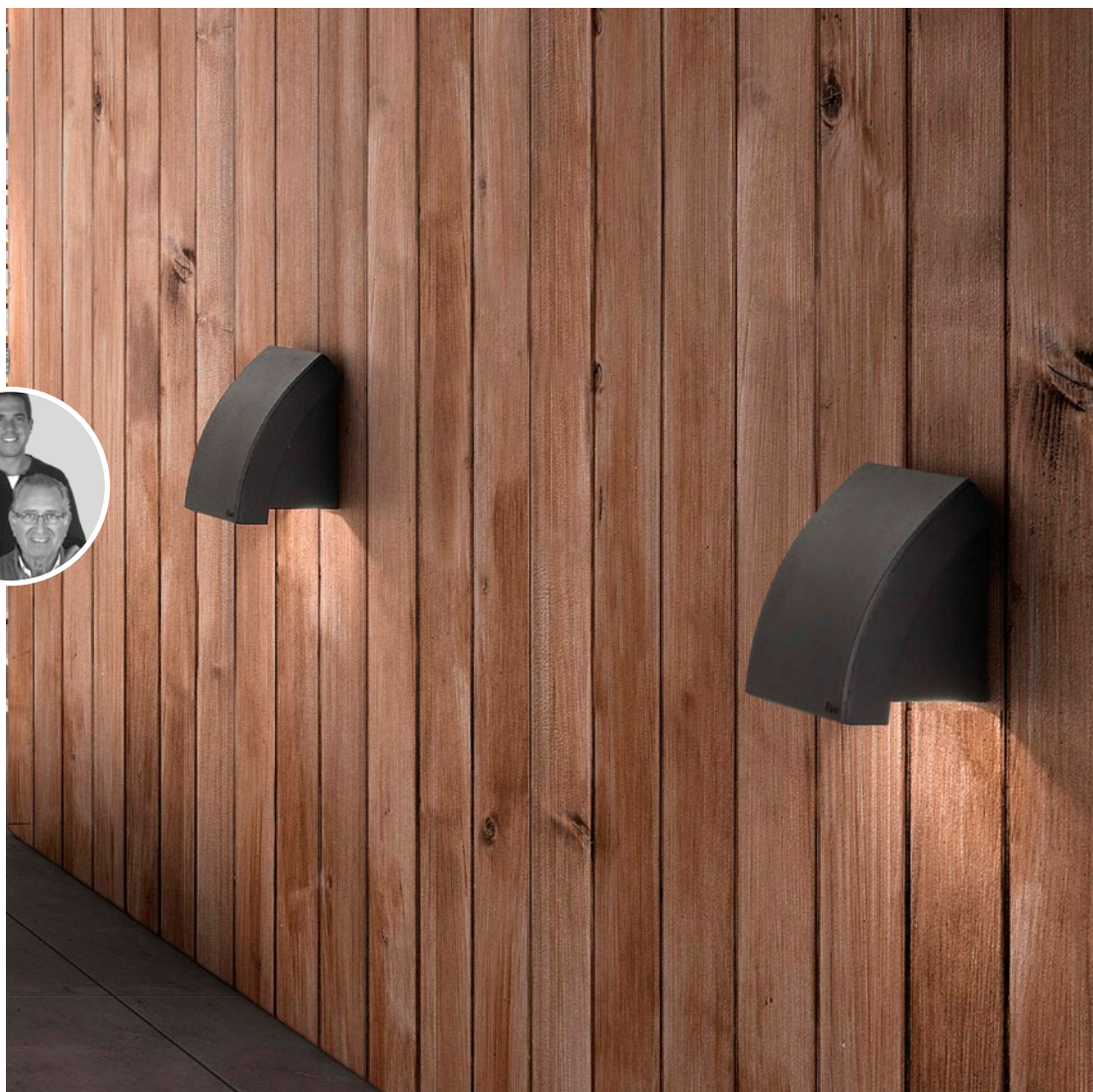

Wall Lamp + Wall Washer

Ref.	74400  dark grey gris oscuro
Bulb	1 xGU10 max 35W not incl. [LED 17325]
Materials	Die Cast Aluminium + Transparent Glass Aluminio Inyectado + Cristal Transparente
V/Hz	100-240V / 50-60 Hz
EEl	A++ to E
Weight	0.65 kg / 1.43 lb

+ info



Áncora

Design: Àlex&Manel
Llusçà



A die casting aluminium structure protects the light source, emitting indirect light up and downwards and bathing the surface on which it is fitted.

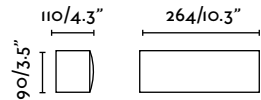

Wall Lamp

Ref.	74401	 dark grey gris oscuro
Bulb	1xE27 20W not incl. [LED 17452]	
Materials	Die Cast Aluminium + Opal Polycarbonate Aluminio Inyectado + Policarbonato Opal	
V/Hz	100-240V / 50-60 Hz	
EEL	A++ to B	
Weight	0.87 kg / 1.92 lb	

+ info



Dragma

Design: Àlex&Manel
Llusçà



Uncluttered and functional. This is DRAGMA, a wall fixture that integrates into the space thanks to its versatility: can direct light upwards, downwards or both at once.

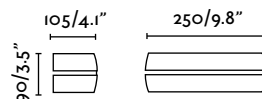

Wall Lamp		IP65
Ref.	71362	dark grey gris oscuro
Bulb	1xG24q-2 18W 4000K incl.	
Materials	Die Cast Aluminium + Translucent Glass Aluminio Inyectado + Cristal Translúcido	
V/Hz	220-240V / 50-60 Hz	
EEL	A to B	
Weight	1.69 kg / 3.73 lb	

+ info





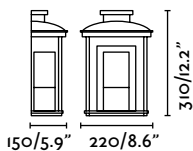

Ceres

Design: Àlex&Manel
Llusçà





Wall Lamp	
Ref.	71607  black negro
Bulb	1xE27 20W not incl. [LED 17452]
Materials	Die Cast Aluminium + Transparent Polycarbonate + Opal Glass Aluminio Inyectado + Policarbonato Transparente + Cristal Opal
V/Hz	100-240V / 50-60 Hz
EEL	A++ to B
Weight	2 kg / 4.4l lb
+ info	  

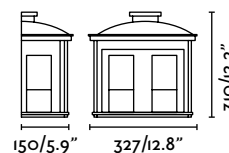

Wall Lamp	
Ref.	71608  black negro
Bulb	2xE27 20W not incl. [LED 17452]
Materials	Die Cast Aluminium + Transparent Polycarbonate + Opal Glass Aluminio Inyectado + Policarbonato Transparente + Cristal Opal
V/Hz	100-240V / 50-60 Hz
EEL	A++ to B
Weight	2.9 kg / 6.39 lb
+ info	  



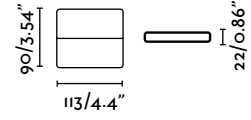

ADAY -1 [new]

Wall Lamp

LED

- Ref.** **70644**  white
blanco
- 70645**  dark grey
gris oscuro

Bulb LED 6W 3000K 450 Lm CRI>80 incl.

Materials Die Cast Aluminium + Opal Polycarbonate
Aluminio Inyectado + Policarbonato Opal

V/Hz 100-240V / 50-60 Hz

EEL A

Weight 0.42 kg / 0.93 lb

+ info    

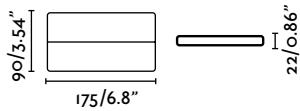

ADAY -2 [new]

Wall Lamp

LED

- Ref.** **70646**  white
blanco
- 70647**  dark grey
gris oscuro





Bulb LED 12W 3000K 950Lm CRI>80 incl.

Materials Die Cast Aluminium + Opal Polycarbonate
Aluminio Inyectado + Policarbonato Opal

V/Hz 220-240V / 50-60 Hz

EEL A

Weight 0.57 kg / 1.26 lb

+ info    



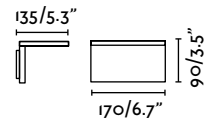

ELE

Wall Lamp

LED

Ref.	74419	 dark grey gris oscuro
Bulb	SMD LED 6W 3000K 450Lm CRI>80 incl.	
Materials	Aluminium + Polycarbonate Aluminio + Policarbonato	
V/Hz	220-240V / 50-60 Hz	
EEL	A+	
Weight	0.65 kg / 1.43 lb	

+ info



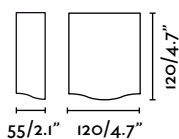







AMON -1

Wall Lamp

LED

Ref.	70577  dark grey gris oscuro
Bulb	COB LED 9W 3000K 330Lm CRI>80 incl.
Materials	Die Cast Aluminium + Translucent Glass Aluminio Inyectado + Cristal Translúcido
V/Hz	100-240V / 50-60 Hz
EEL	A
Weight	0.57 kg / 1.26 lb

+ info     

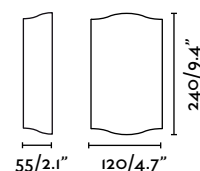

AMON -2

Wall Lamp

LED

Ref.	70578  dark grey gris oscuro
Bulb	COB LED 18W 3000K 660Lm CRI>80 incl.
Materials	Die Cast Aluminium + Translucent Glass Aluminio Inyectado + Cristal Translúcido
V/Hz	100-240V / 50-60 Hz
EEL	A
Weight	1.12 kg / 2.47 lb

+ info     



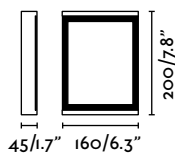

RADHA

Wall Lamp

LED

Ref.	70816	 white blanco
Bulb	SMD LED 6W 3000K 310Lm CRI>80 incl.	
Materials	Aluminium + Tempered Glass Aluminio + Cristal Templado	
V/Hz	220-240V / 50-60 Hz	
EEL	A++ to A	
Weight	1.15 kg / 2.54 lb	

HF



+ info  **IP54** **DRIVER**  **130°**

HF Until stock exhaustion
Hasta final de stock
Jusqu'à la fin de stock

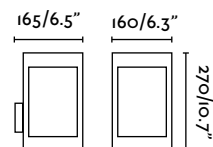

MARE

Wall Lamp

LED

Ref.	70635	 dark grey gris oscuro
Bulb	COB LED 3W 3000K 300Lm incl.	
Materials	Die Cast Aluminium + Transparent Glass Aluminio Inyectado + Cristal Transparente	
V/Hz	220-240V / 50-60 Hz	
EEL	A++	
Weight	2.19 kg / 4.83 lb	

+ info  **IP54** **DRIVER** 



SUN [new]

Wall Lamp

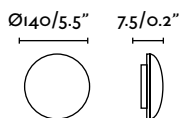

Ref.	70823	 dark grey gris oscuro
Bulb	SMD LED 5W 3000K 275Lm incl.	
Materials	Aluminium + Opal Polycarbonate Aluminio + Policarbonato Opal	
V/Hz	100-240V / 50-60 Hz	
EEI	A++ to A	
Weight	0.29 kg / 0.64 lb	

+ info   



VERTICE [new]

Wall Lamp

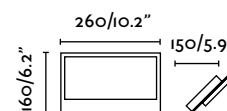

Ref.	70822	 dark grey gris oscuro
Bulb	SMD LED 9W 3000K 810Lm incl.	
Materials	Aluminium + Opal Polycarbonate Aluminio + Policarbonato Opal	
V/Hz	100-240V / 50-60 Hz	
EEI	A++ to A	
Weight	0.84 kg / 1.85 lb	

+ info  



Swivel flaps
Aletas direccionables

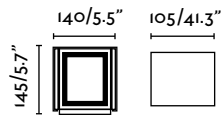

OLAN [new]

Wall
Lamp

LED

Ref. **70637**  dark grey
gris oscuro

Bulb LED 6W 3000K 600Lm CRI>80 incl.

Materials Die Cast Aluminium + Transparent Glass
Aluminio Inyectado + Cristal Transparente

V/Hz 100-240V / 50-60 Hz

EEL A

Weight 0.99 kg / 2.18 lb

+ info

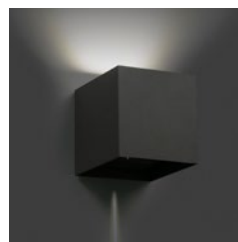



Swivel flaps
Aletas direccionables

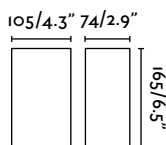

BLIND

Wall
Lamp

LED

Ref. **70634**  dark grey
gris oscuro

Bulb HIGH POWER LED 6W 3000K 600Lm incl.

Materials Die Cast Aluminium + Transparent Glass
Aluminio Inyectado + Cristal Transparente

V/Hz 110-240V / 50-60 Hz

EEL A++

Weight 1.07 kg / 2.36 lb

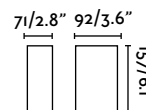
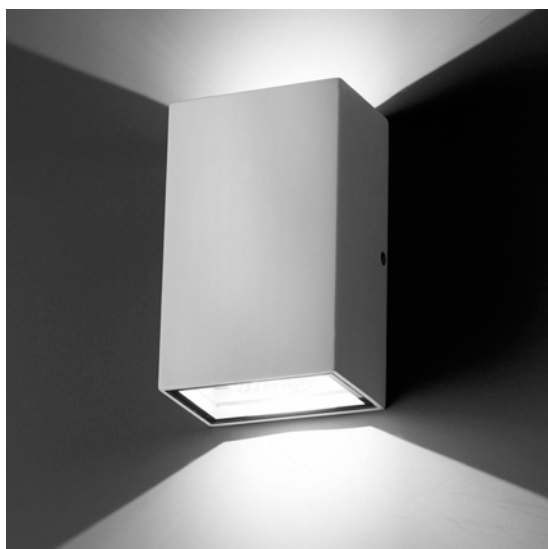
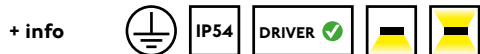

LING

Wall
Lamp

LED

Ref. **70812**  dark grey
gris oscuro

70813  white
blanco

Bulb HIGH POWER LED 6W 4000K 315Lm incl.

Materials Die Cast Aluminium + Transparent Glass
Aluminio Inyectado + Cristal Transparente

V/Hz 220-240V / 50-60 Hz

EEL A++ to A

Weight 1.1 kg / 2.43 lb

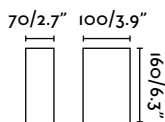

LACE

Wall
Lamp

LED

Ref. **70811**  dark grey
gris oscuro

Bulb HIGH POWER LED 6W 4000K 315Lm incl.

Materials Die Cast Aluminium + Transparent Glass
Aluminio Inyectado + Cristal Transparente

V/Hz 110-240V / 50-60 Hz

EEL A++ to A

Weight 0.91 kg / 2.01 lb

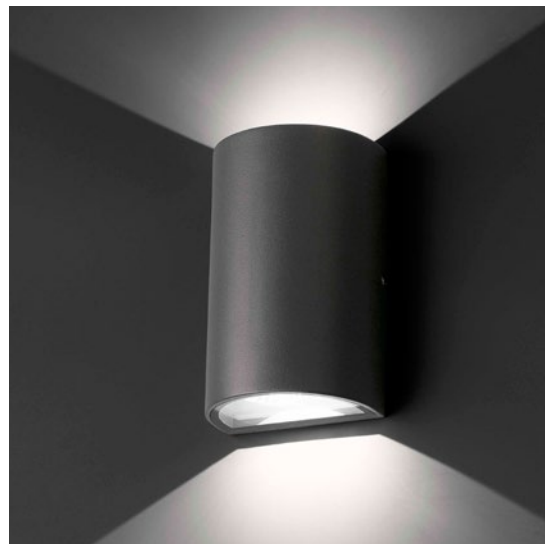



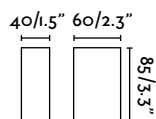

CANON

Wall Lamp

LED

Ref.	70566N		dark grey gris oscuro	3000 K
	70567N		white blanco	3000 K

Bulb HIGH POWER LED 4W 3000K 130Lm incl.

Materials Die Cast Aluminium + Tempered Glass
Aluminio Inyectado + Cristal Templado

V/Hz 100-240V / 50-60 Hz

EEL A

Weight 0.3 kg / 0.66 lb

+ info      

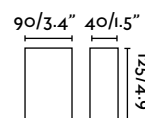

CRATA

Wall Lamp

LED

Ref.	70568		dark grey gris oscuro
	70569		white blanco

Bulb HIGH POWER LED 6W 4000K 130Lm incl.

Materials Die Cast Aluminium + Tempered Glass
Aluminio Inyectado + Cristal Templado

V/Hz 100-240V / 50-60 Hz

EEL A

Weight 0.66 kg / 1.46 lb

+ info      

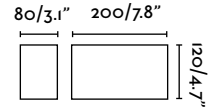

TANE

Wall
Lamp

LED

Ref.	72269	 dark grey gris oscuro
Bulb	SMD LED 6W 3000K 400Lm incl.	
Materials	Aluminium + Translucent Glass Aluminio + Cristal Translúcido	
V/Hz	220-240V / 50-60 Hz	
EEL	A++	
Weight	0.8 kg / 1.76 lb	

+ info

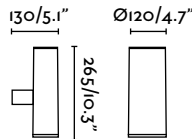

PISTÓN

Wall
Lamp

Ref.	70808	 grey gris
Bulb	2xGU10 max 50W not incl. [LED 17316]	
Materials	Die Cast Aluminium + Transparent Glass Aluminio Inyectado + Cristal Transparente	
V/Hz	100-240V / 50-60 Hz	
EEL	A++ to E	
Weight	1.14 kg / 2.51 lb	

+ info

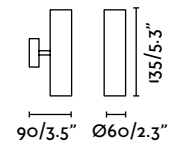

COBO

Wall
Lamp

IP65

LED

Ref.	70404	 dark grey gris oscuro
Bulb	COB LED 12W 4000K 600Lm CRI>80 incl.	
Materials	Die Cast Aluminium + Glass Aluminio Inyectado + Cristal	
V/Hz	100-240V / 50-60 Hz	
EEL	A+	
Weight	1.79 kg / 3.95 lb	

+ info



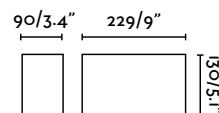

LATINA

Wall Lamp

IP65

Ref. **70694**  dark grey / gris oscuro

HF

Bulb 1xG24d-3 26W not incl. [I5905]

Materials Aluminium + Translucent Glass / Aluminio + Cristal Translúcido

V/Hz 220-240V / 50-60 Hz

EEL A++ to B

Weight 1.79 kg / 3.95 lb

+ info



HF Until stock exhaustion / Hasta final de stock / Jusqu'à la fin de stock

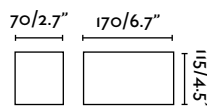

DIDOT

Wall Lamp

Ref. **71368**  grey / gris

71369  black / negro

Bulb 1xR7S JP78 Max 100W incl.

Materials Aluminium + Translucent Glass / Aluminio + Cristal Translúcido

V/Hz 220-240V / 50-60 Hz

EEL A++ to D

Weight 0.8 kg / 1.76 lb

+ info

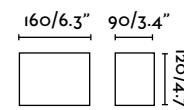

LACRE

Wall Lamp

Ref. **70802**  dark grey / gris oscuro

Bulb 1xE27 max 100W not incl. [LED 17453]

Materials Die Cast Aluminium + Transparent Glass / Aluminio Inyectado + Cristal Transparente

V/Hz 100-240V / 50-60 Hz

EEL A++ to E

Weight 1.02 kg / 2.25 lb

+ info



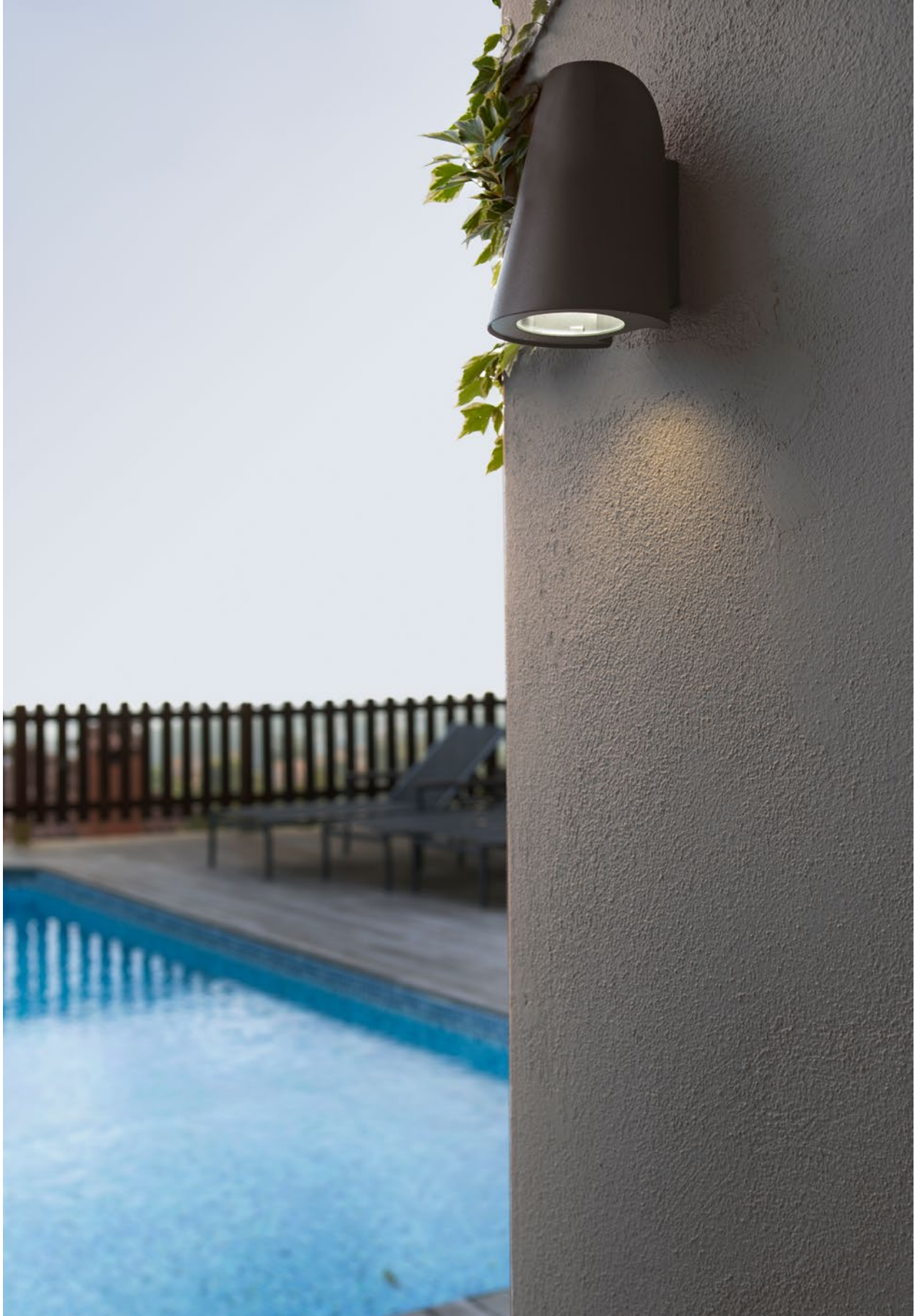

TINIA

Wall Lamp

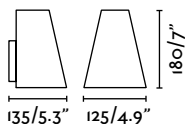

Ref.	71353 ● dark grey / gris oscuro
Bulb	1xE27 max 60W not incl. [LED 17453]
Materials	Aluminium + Polycarbonate / Aluminio + Policarbonato
V/Hz	100-240V / 50-60 Hz
EEL	A++ to E
Weight	0.57 kg / 1.26 lb
+ info	  

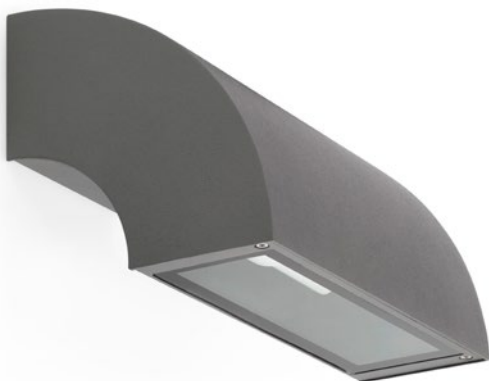

CAPRI

Wall Lamp

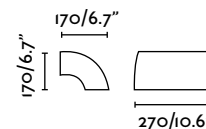

Ref.	70565 ● dark grey / gris oscuro
Bulb	1xE27 15W not incl. [LED 17453]
Materials	Die Cast Aluminium + Tempered Glass / Aluminio Inyectado + Cristal Templado
V/Hz	100-240V / 50-60 Hz
EEL	A++ to B
Weight	2.3 kg / 5.07 lb
+ info	   

PAPOO

Wall Lamp

LED

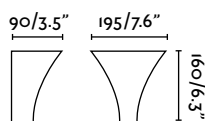

Ref.	72267 ● dark grey / gris oscuro
Bulb	LED 4W 4000K 200lm incl.
Materials	Aluminium + Translucent Glass / Aluminio + Cristal Translúcido
V/Hz	220-240V / 50-60 Hz
EEL	A++ to A
Weight	0.6 kg / 1.32 lb
+ info	   



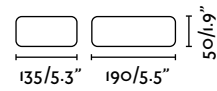

KAMI

Wall Lamp

INOX 316

LED

Ref. 72283 matt nickel+white
níquel mate+blanco

Bulb HIGH POWER LED 6W 3000K 140Lm incl.

Materials 316 Stainless Steel + Polycarbonate
Acero Inoxidable 316 + Policarbonato

V/Hz 100-240V / 50-60 Hz

EEl A++

Weight 0.44 kg / 0.97 lb

+ info





NEFTIS

Wall Lamp

INOX 316 LED

Ref.	72284	 matt nickel níquel mate
Bulb	SMD LED 7W 3000K 360Lm incl.	
Materials	316 Stainless Steel + Polycarbonate Acero Inoxidable 316 + Policarbonato	
V/Hz	100-240V / 50-60 Hz	
EEl	A++	
Weight	0.51 kg / 1.12 lb	

+ info      

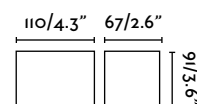

ION-2

Wall Lamp

INOX

Ref.	71385	 matt nickel níquel mate
Bulb	2xGX53 9W not incl. [LED 17340]	
Materials	Stainless Steel + Transparent Glass Acero Inoxidable + Cristal Transparente	
V/Hz	100-240V / 50-60 Hz	
EEl	A++ to B	
Weight	0.43 kg / 0.95 lb	

+ info     

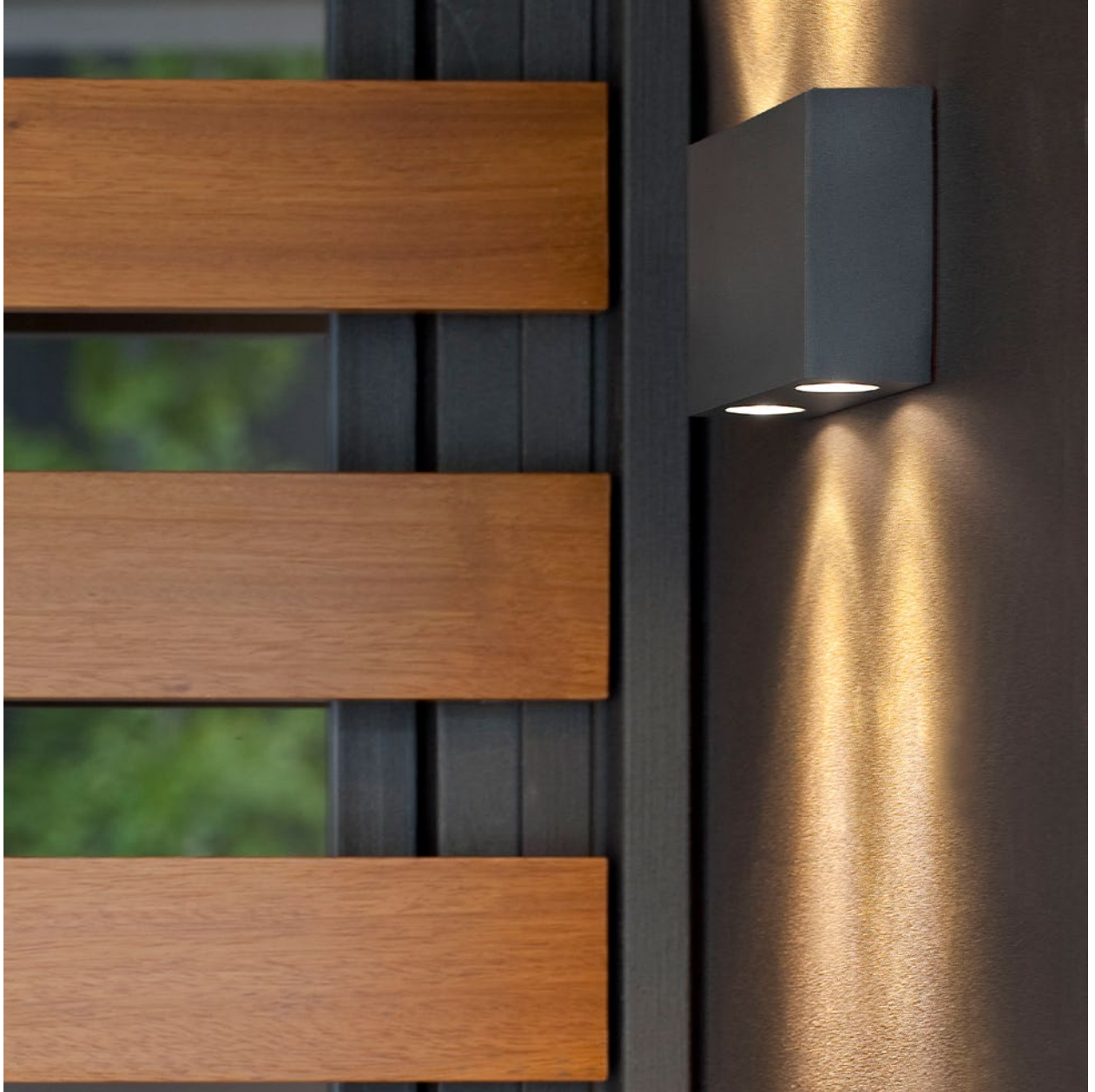

MARAT -2

**Wall
Lamp**

LED

Ref.	70552  dark grey gris oscuro
Bulb	HIGH POWER LED 4W 3000K 300Lm incl.
Materials	Die Cast Aluminium + Transparent Glass Aluminio Inyectado + Cristal Transparente
V/Hz	220-240V / 50-60 Hz
EEI	A++ to A
Weight	0.6 kg / 1.32 lb

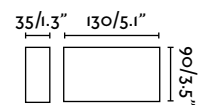

+ info      

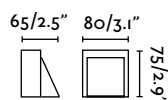

KAMAL - 1

Wall Lamp

LED

Ref.	70556	● dark grey gris oscuro
Bulb	HIGH POWER LED 1W 3000K 70Lm incl.	
Materials	Die Cast Aluminium + Tempered Glass Aluminio Inyectado + Cristal Templado	
V/Hz	100-240V / 50-60 Hz	
EEL	A	
Weight	0.33 kg / 0.73 lb	

+ info     

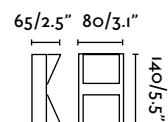
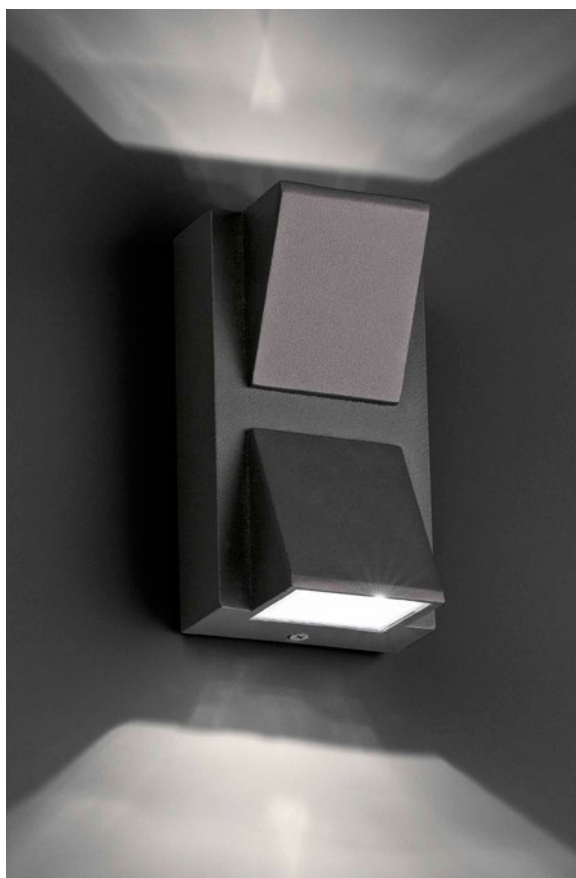





KAMAL - 2

Wall Lamp

LED

Ref.	70560	● dark grey gris oscuro
Bulb	HIGH POWER LED 2W 3000K 110Lm incl. Die Cast Aluminium + Tempered Transparent Glass	
Materials	Aluminio Inyectado + Cristal Templado Transparente	
V/Hz	220-240V / 50-60 Hz	
EEL	A+	
Weight	0.5 kg / 1.10 lb	

+ info     



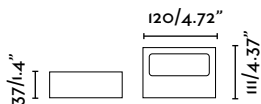

TAIMA [new]

Wall Lamp

ORIENTABLE **LED**

Ref.	71388	● dark grey gris oscuro
Bulb	COB LED 6W 3000K 310Lm incl.	
Materials	Aluminium + Transparent Glass Aluminio + Cristal Transparente	
V/Hz	220-240V / 50-60 Hz	
EEL	A++ to A	
Weight	0.68 kg / 1.50 lb	

+ info

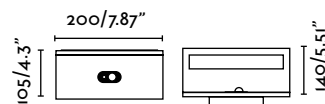
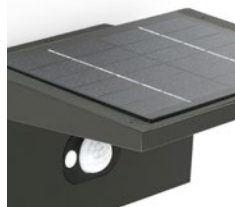

TEBA [new]

Wall Lamp

SOLAR PANEL **PLACA SOLAR** **LED** **PIR**

Ref.	74414	● dark grey gris oscuro
Bulb	SMD LED 2,5W 4000K max 150Lm incl.	
Materials	Die Cast Aluminium + Opal Polycarbonate Aluminio Inyectado + Policarbonato Opal	
Battery	3,7 V / 2200 mA	
EEL	A+	
Weight	0.8 kg / 1.76 lb	

+ info



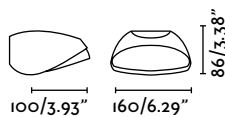

NUM [new]

Wall Lamp

LED

Ref.	71197	 dark grey gris oscuro
Bulb	SMD LED 7W 3000K 350Lm CRI>80 incl.	
Materials	Aluminium + Opal Polycarbonate Aluminio + Policarbonato Opal	
V/Hz	100-240V / 50-60 Hz	
EEL	A	
Weight	0.6 kg / 1.32 lb	

+ info    



INCLUDED STICKERS
STICKERS INCLUIDOS

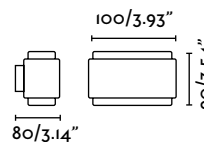
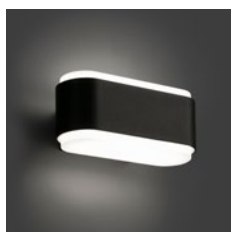

ZOE [new]

Wall Lamp

LED

Ref.	72271	 black negro
Bulb	SMD LED 5W 4000K 220Lm incl.	
Materials	Aluminium + Opal Polycarbonate Aluminio + Policarbonato Opal	
V/Hz	220-240V / 50-60 Hz	
EEL	A++ to A	
Weight	0.61 kg / 1.34 lb	

+ info    

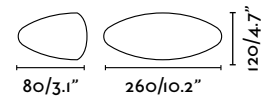

INARI

**Wall
Lamp**

LED

ORIENTABLE

Ref. 70820  dark grey
gris oscuro

Bulb SMD LED 9W 3000K 230Lm CRI>80 incl.

Materials Aluminium + Opal Polycarbonate
Aluminio + Policarbonato Opal

V/Hz 100-240V / 50-60 Hz

EEL A++ to A

Weight 0.74 kg / 1.63 lb

+ info



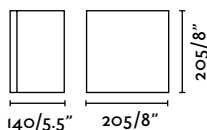

NAOMI

Wall Lamp

LED 3 POSITIONS: WALL LAMP, CEILING, POST LAMP
3 POSICIONES: APLIQUE, PLAFON, SOBREMURO

Ref.	70636  dark grey / gris oscuro
Bulb	COB LED 6W 3000K 600Lm CRI>80 incl.
Materials	Die Cast Aluminium + Opal Polycarbonate / Aluminio Inyectado + Policarbonato Opal
V/Hz	220-240V / 50-60 Hz
EEL	A
Weight	1.45 kg / 3.20 lb

+ info  **IP54** **DRIVER** 

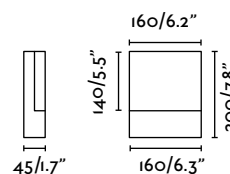

NISHA

Wall Lamp

LED

Ref.	70817  dark grey / gris oscuro
Bulb	SMD LED 6W 4000K 560Lm CRI>80 incl.
Materials	Aluminium + Opal Polycarbonate / Aluminio + Policarbonato Opal
V/Hz	100-240V / 50-60 Hz
EEL	A++ to A
Weight	0.85 kg / 1.87 lb

+ info  **IP54** **DRIVER** 

HF

HF Until stock exhaustion / Hasta final de stock / Jusqu'à la fin de stock



Serigraphic not incl. / Serigrafía no incl.

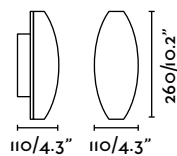

BACO

Wall Lamp

LED 2 POSITIONS / 2 POSICIONES

Ref.	70819  grey / gris
Bulb	SMD LED 6W 4000K 620Lm CRI>80 incl.
Materials	Aluminium + Opal Polycarbonate / Aluminio + Policarbonato Opal
V/Hz	100-240V / 50-60 Hz
EEL	A++ to A
Weight	0.65 kg / 1.43 lb

+ info  **IP54** **DRIVER** 



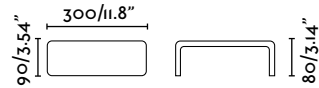

BRACKET [new]

Wall Lamp

LED

Ref.	72272	 dark grey / gris oscuro
Bulb	SMD LED 6W 3000K 270Lm CRI>80 incl.	
Materials	Aluminium + Opal Glass / Aluminio + Cristal Opal	
V/Hz	220-240V / 50-60 Hz	
EEL	A	
Weight	0.89 kg / 1.96 lb	

+ info







USAGUI [new]

Wall Lamp

IP65 LED

Ref.	70769	 dark grey gris oscuro
	70770	 white blanco
Bulb	LED 36W 4000K 2000Lm CRI>80 incl.	
Materials	Die Cast Aluminium + Opal Glass Aluminio Inyectado + Cristal Opal	
V/Hz	220-240V / 50-60 Hz	
EEl	A++ to A	
Weight	2.34 kg / 5.16 lb	

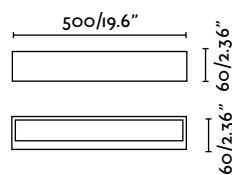

+ info     



TOLUCA [new]

Wall Lamp

LED

Ref.	71050	 dark grey gris oscuro
	71051	 white blanco
Bulb	SMD LED 16W 3000K 500Lm incl.	
Materials	Aluminium + Tempered Transparent Glass Aluminio + Cristal Templado Transparente	
V/Hz	220-240V / 50-60 Hz	
EEl	A++ to A	
Weight	0.87 kg / 1.92 lb	

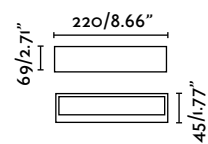

+ info    

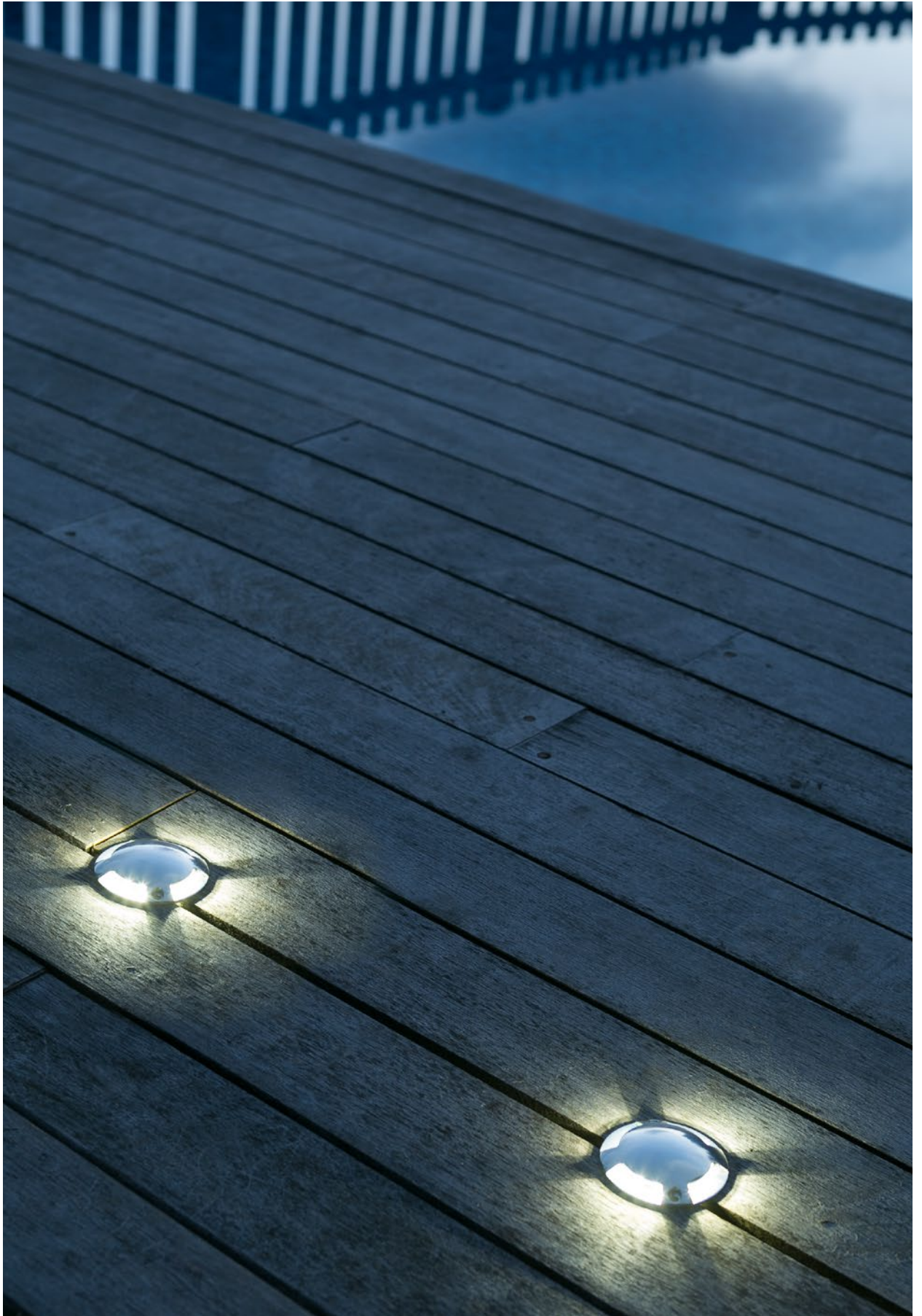

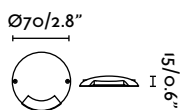

KEENAN -2

IP67 LED

Surface

Ref. **70546** nickel
níquel

Bulb LED 0,5W 6500K 20Lm incl.
Gear not incl. [98101050 ELT 50W]

Materials Aluminium + Transparent Glass
Aluminio + Cristal Transparente

V/Hz 12V AC

EEL A++ to A

Weight 0.1 kg / 0.22 lb

+ info

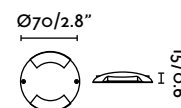

KEENAN

IP67 LED

Surface

Ref. **70547** nickel
níquel

Bulb LED 0,8W 6500K 40Lm incl.
Gear not incl. [98101050 ELT 50W]

Materials Aluminium + Transparent Glass
Aluminio + Cristal Transparente

V/Hz 12V AC

EEL A++ to A

Weight 0.1 kg / 0.22 lb

+ info

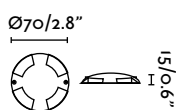

KEENAN -3

IP67 LED

Surface

Ref. **70564** nickel
níquel

Bulb LED 1W 6500K 80Lm incl.
Gear not incl. [98101050 ELT 50W]

Materials Aluminium + Transparent Glass
Aluminio + Cristal Transparente

V/Hz 12V AC

EEL A++ to A

Weight 0.1 kg / 0.22 lb

+ info

Exclusive use with magnetic transformer
 Uso exclusivo transformador magnético
 Utilisation exclusif avec transformateur magnétique

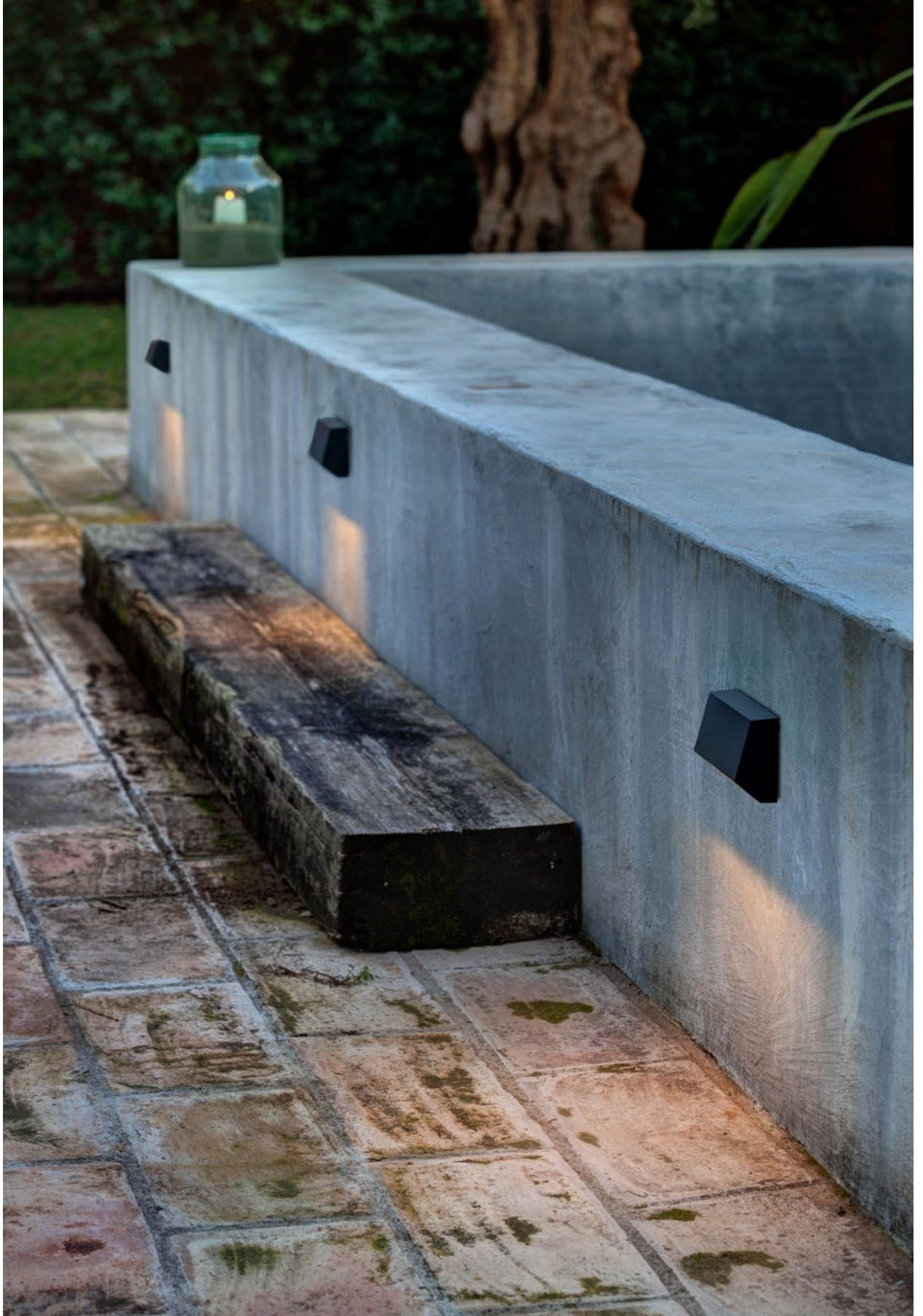

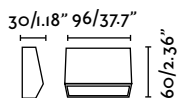

MUST-1 [new]

Wall Lamp

IP65

LED

Ref. **70657** ● dark grey / gris oscuro

Bulb SMD LED 1,5W 3000K 80 Lm CRI>80 incl.

Materials ABS + Transparent Polycarbonate / ABS + Policarbonato Transparente

V/Hz 200-240V / 50-60 Hz

EEL A

Weight 0.09 kg / 0.20 lb

+ info

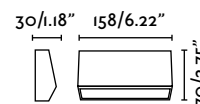

MUST-2 [new]

Wall Lamp

IP65

LED

Ref. **70658** ● dark grey / gris oscuro

Bulb SMD LED 3W 3000K 150Lm CRI>80 incl.

Materials ABS + Transparent Polycarbonate / ABS + Policarbonato Transparente

V/Hz 200-240V / 50-60 Hz

EEL A

Weight 0.14 kg / 0.31 lb

+ info

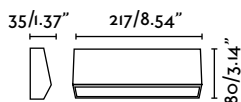

MUST-3 [new]

Wall Lamp

IP65

LED

Ref. **70659** ● dark grey / gris oscuro

Bulb SMD LED 4W 3000K 210Lm CRI>80 incl.

Materials ABS + Transparent Polycarbonate / ABS + Policarbonato Transparente

V/Hz 200-240V / 50-60 Hz

EEL A

Weight 0.19 kg / 0.42 lb

+ info



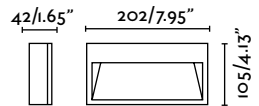

PATH [new]

Wall Lamp

LED

Ref.	70508	dark grey gris oscuro
Bulb	SMD LED 9W 3000K 390 Lm CRI>80 incl.	
Materials	Die Cast Aluminium + Transparent Polycarbonate Aluminio Inyectado + Policarbonato Transparente	
V/Hz	100-240V / 50-60 Hz	
EEL	A++ to A	
Weight	0.7 kg / 1.54 lb	

+ info



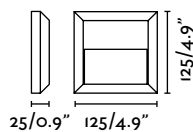





GRANT

Wall Lamp

IP65 LED

Ref.	70655 ● dark grey / gris oscuro
Bulb	SMD LED 3W 3000K 65Lm CRI>80 incl.
Materials	ABS + Polycarbonate / ABS + Policarbonato
V/Hz	100-240V / 50-60 Hz
EEL	A++
Weight	0.2 kg / 0.44 lb

+ info     

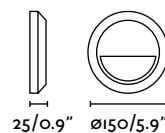

GRANT

Wall Lamp

IP65 LED

Ref.	70656 ● dark grey / gris oscuro
Bulb	SMD LED 3W 3000K 65Lm CRI>80 incl.
Materials	ABS + Polycarbonate / ABS + Policarbonato
V/Hz	100-240V / 50-60 Hz
EEL	A++
Weight	0.2 kg / 0.44 lb

+ info     





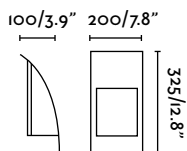

UNIQUE POSITION
UNICA POSICIÓN

ERIO

Wall Lamp

Ref.	72270	 dark grey gris oscuro
Bulb	1xE27 14W not incl. [LED 17454]	
Materials	Aluminium + Opal Polycarbonate Aluminio + Policarbonato Opal	
V/Hz	100-240V / 50-60 Hz	
EEL	A++ to B	
Weight	0.87 kg / 1.92 lb	

+ info

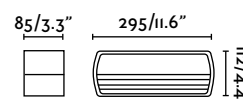

COAL

Wall Lamp

Ref.	71365	 dark grey gris oscuro
Bulb	1xG24d-3 max 26W not incl. [I5905]	
Materials	Die Cast Aluminium + Opal PVC Aluminio Inyectado + Opal PVC	
V/Hz	220-240V / 50-60 Hz	
EEL	A to B	
Weight	1.27 kg / 2.80 lb	

+ info

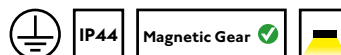



SUMA

**Wall
Lamp**

Ref.	70749  dark grey gris oscuro
Bulb	2xE27 15W not incl. [LED 17453]
Materials	Die Cast Aluminium + Translucent Glass Aluminio Inyectado + Cristal Translúcido
V/Hz	100-240V / 50-60 Hz
EEl	A++ to A
Weight	2.9 kg / 6.39 lb

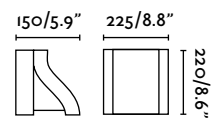

+ info   

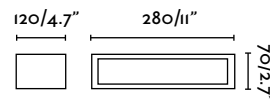

NATRON

Wall Lamp

Ref.	70887 ● dark grey / gris oscuro
Bulb	1xE27 max 100W not incl. [LED 17453]
Materials	Die Cast Aluminium + Transparent Glass / Aluminio Inyectado + Cristal Transparente
V/Hz	100-240V / 50-60 Hz
EEL	A++ to E
Weight	1.39 kg / 3.06 lb

+ info   

MOL

Wall Lamp

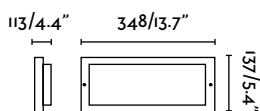

Ref.	70720 ● dark grey / gris oscuro
Bulb	1xE27 IIW not incl. [LED 17453]
Materials	Die Cast Aluminium + Opal Polycarbonate / Aluminio Inyectado + Policarbonato Opal
V/Hz	100-240V / 50-60 Hz
EEL	A++ to B
Weight	0.89 kg / 1.96 lb

+ info   

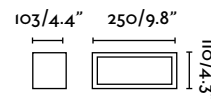

TEJO

Wall Lamp

Ref.	70573 ● dark grey / gris oscuro
Bulb	1xE27 20W not incl. [LED 17453]
Materials	Die Cast Aluminium + Opal Polycarbonate / Aluminio Inyectado + Policarbonato Opal
V/Hz	100-240V / 50-60 Hz
EEL	A++ to B
Weight	1.1 kg / 2.43 lb

+ info    



SOR

Wall Lamp

Ref.	72265		dark grey gris oscuro
	72266		dark grey gris oscuro
Bulb	1xE27 II W not incl. [LED 17453]		
Materials	Die Cast Aluminium + Opal Polycarbonate Aluminio Inyectado + Policarbonato Opal		
V/Hz	100-240V / 50-60 Hz		
EEL	A++ to B		
Weight	0.70-1 kg / 1.54-2.20 lb		

+ info



HF

Until stock exhaustion
Hasta final de stock
Jusqu'à la fin de stock

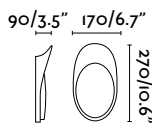

Ref. 72265

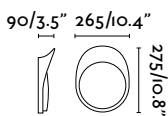

Ref. 72266

HF



Ref. 72265



Ref. 72266



FENES - I

Wall Lamp

Ref.	72004		dark grey gris oscuro
Bulb	1xG24d-3 26W not incl. [I5905]		
Materials	Die Cast Aluminium + Opal Polycarbonate Aluminio Inyectado + Policarbonato Opal		
V/Hz	220-240V / 50-60 Hz		
EEL	A++ to B		
Weight	2.2 kg / 4.85 lb		

+ info

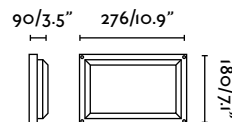

180/7.1"

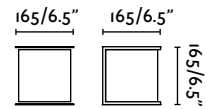

KUBICK

Wall Lamp

Ref.	70689	● dark grey gris oscuro
	70715	● grey gris
Bulb	1xE27 max 60W not incl. [LED 17453]	
Materials	Die Cast Aluminium + Opal PVC Aluminio Inyectado + Opal PVC	
V/Hz	100-240V / 50-60 Hz	
EEl	A++ to E	
Weight	1.21 kg / 2.67 lb	

+ info



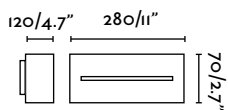

WEST -1

Wall Lamp

Ref.	70888	 dark grey gris oscuro
Bulb	1xE27 max 100W not incl. [LED 17453]	
Materials	Die Cast Aluminium + Translucent Glass Aluminio Inyectado + Cristal Translúcido	
V/Hz	100-240V / 50-60 Hz	
EEL	A++ to E	
Weight	0.05 kg / 0.11 lb	

+ info

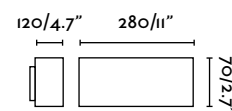

WEST -2

Wall Lamp

Ref.	70899	 dark grey gris oscuro
Bulb	1xE27 max 100W not incl. [LED 17453]	
Materials	Die Cast Aluminium + Translucent Glass Aluminio Inyectado + Cristal Translúcido	
V/Hz	100-240V / 50-60 Hz	
EEL	A++ to E	
Weight	1.18 kg / 2.60 lb	

+ info



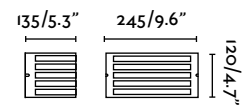

FEDON

Wall Lamp

INOX

Ref.	70714	 matt nickel níquel mate
Bulb	1xG24d-3 max 60W not incl. [17453]	
Materials	Stainless Steel + Opal PVC Acero Inoxidable + Opal PVC	
V/Hz	100-240V / 50-60 Hz	
EEl	A++ to E	
Weight	0.9 kg / 1.98 lb	

+ info



NEGUS

Wall Lamp

Ref.	70696  grey gris
Bulb	1xE27 max 60W not incl. [LED 17453]
Materials	Die Cast Aluminium + Opal Polycarbonate Aluminio Inyectado + Policarbonato Opal
V/Hz	100-240V / 50-60 Hz
EEL	A++ to E
Weight	0.9 kg / 1.98 lb

+ info   

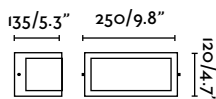

BONN -1

Wall Lamp

Ref.	70702  dark grey gris oscuro
Bulb	1xG24d-3 26W not incl. [15905]
Materials	Die Cast Aluminium + Translucent PVC Aluminio Inyectado + PVC Translúcido
V/Hz	220-240V / 50-60 Hz
EEL	A++ to B
Weight	1.5 kg / 3.31 lb

+ info    

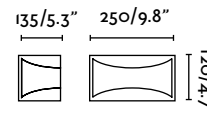

BONN -2

Wall Lamp

Ref.	70697  dark grey gris oscuro
Bulb	1xE27 max 100W not incl. [LED 17453]
Materials	Die Cast Aluminium + PVC Aluminio Inyectado + PVC
V/Hz	100-240V / 50-60 Hz
EEL	A++ to E
Weight	1.1 kg / 2.43 lb

+ info   

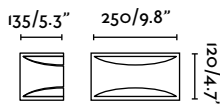



CELA -2

Wall
Lamp

INOX

Ref.	72281	 matt nickel níquel mate
Bulb	1xE27 15W not incl. [LED 17454]	
Materials	Stainless Steel + Opal Polycarbonate Acero Inoxidable + Policarbonato Opal	
V/Hz	100-240V / 50-60 Hz	
EEL	A++ to E	
Weight	0.6 kg / 1.32 lb	



+ info



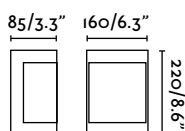

CELA -1

Wall Lamp

INOX

Ref.	72280	 matt nickel níquel mate
Bulb	1xE27 15W not incl. [LED 17454]	
Materials	Stainless Steel + Opal Polycarbonate Acero Inoxidable + Policarbonato Opal	
V/Hz	100-240V / 50-60 Hz	
EEl	A++ to E	
Weight	0.6 kg / 1.32 lb	

+ info

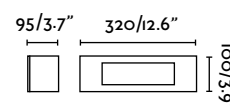

DORVAL -1

Wall Lamp

INOX

Ref.	72260	 matt nickel níquel mate
Bulb	1xE27 15W not incl. [LED 17453]	
Materials	Stainless Steel + Opal Polycarbonate Acero Inoxidable + Policarbonato Opal	
V/Hz	100-240V / 50-60 Hz	
EEl	A++ to B	
Weight	0.55 kg / 1.21 lb	

+ info

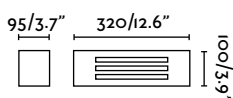

DORVAL -2

Wall Lamp

INOX

Ref.	72261	 matt nickel níquel mate
Bulb	1xE27 15W not incl. [LED 17453]	
Materials	Stainless Steel + Opal Polycarbonate Acero Inoxidable + Policarbonato Opal	
V/Hz	100-240V / 50-60 Hz	
EEl	A++ to B	
Weight	0.55 kg / 1.21 lb	

+ info





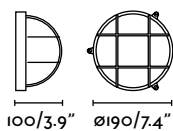

NORAY

Wall Lamp

IP65 **MADE IN EUROPE**
HECHO EN EUROPA

Ref.	70999  brass latón
Bulb	1xE27 max 60W not incl. [LED 17453]
Materials	Brass + Striped Glass Latón + Cristal Rallado
V/Hz	100-240V / 50-60 Hz
EEL	A++ to E
Weight	1.52 kg / 3.35 lb

+ info   

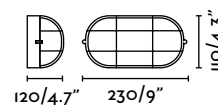

CABO

Wall Lamp

IP65 **MADE IN EUROPE**
HECHO EN EUROPA

Ref.	70998  brass latón
Bulb	1xE27 max 60W not incl. [LED 17453]
Materials	Brass + Striped Glass Latón + Cristal Rallado
V/Hz	100-240V / 50-60 Hz
EEL	A++ to E
Weight	1.52 kg / 3.35 lb

+ info  





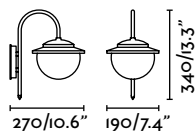

VISNU

Wall Lamp

LED

Ref.	70818	 dark grey gris oscuro
Bulb	SMD LED 9W 700Lm CRI>80 incl.	
Materials	Aluminium + Opal Polycarbonate Aluminio + Policarbonato Opal	
V/Hz	100-240V / 50-60 Hz	
EEL	A++ to A	
Weight	1.21 kg / 2.67 lb	

HF



HF **Until stock exhaustion**
Hasta final de stock
Jusqu'à la fin de stock

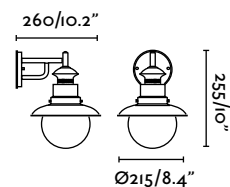

RUSTIC

Wall Lamp

Ref.	71147	 brown marrón
Bulb	1xE27 60W not incl. [LED 17453]	
Materials	Metal + Transparent Glass Metal + Cristal Transparente	
V/Hz	100-240V / 50-60 Hz	
EEL	A++ to E	
Weight	1.1 kg / 2.43 lb	

HF



HF **Until stock exhaustion**
Hasta final de stock
Jusqu'à la fin de stock



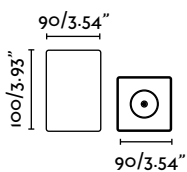

TAMI [new]

Ceiling Lamp

LED

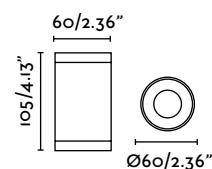

Ref.	70799	 dark grey gris oscuro
Bulb	LED 12W 3000K 960Lm CRI >80 incl.	
Materials	Die Cast Aluminium + Transparent Glass Aluminio Inyectado + Cristal Transparente	
V/Hz	100-240V / 50-60 Hz	
EEL	A	
Weight	0.89 kg / 1.96 lb	

+ info    



OLOT [new]

Ceiling Lamp

Ref.	71372	 white blanco
	71374	 dark grey gris oscuro
Bulb	1xGU10 max 35W not incl. [LED 17317]	
Materials	Aluminium + Transparent Glass Aluminio + Cristal Transparente	
V/Hz	100-240V / 50-60 Hz	
EEL	A++ to E	
Weight	0.24 kg / 0.53 lb	

+ info  



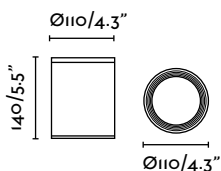

TASA

Ceiling Lamp



[new]

Ref.	70806		dark grey gris oscuro
	70821		white blanco
Bulb	1xE27 PAR30 max 75W not incl. [LED 17403]		
Materials	Die Cast Aluminium + Tempered Glass Aluminio Inyectado + Cristal Templado		
V/Hz	100-240V / 50-60 Hz		
EEL	A++ to E		
Weight	0.73 kg / 1.61 lb		

+ info

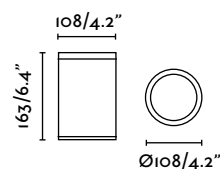

TASA -2

Ceiling Lamp

Ref.	70574		dark grey gris oscuro
Bulb	1xE27 15W not incl. [LED 17453]		
Materials	Die Cast Aluminium + Tempered Glass Aluminio Inyectado + Cristal Templado		
V/Hz	100-240V / 50-60 Hz		
EEL	A++ to B		
Weight	0.9 kg / 1.98 lb		

+ info





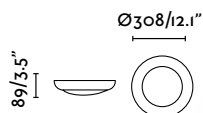

INA [new]

Ceiling Lamp

IP65 LED

Ref.	70724	white blanco
Bulb	SMD LED 15W 4000K 1300Lm CRI>80 incl.	
Materials	Polycarbonate + Opal Polycarbonate Policarbonato + Policarbonato Opal	
V/Hz	100-240V / 50-60 Hz	
EEL	A++ to A	
Weight	0.79 kg / 1.74 lb	

+ info IP65 DRIVER

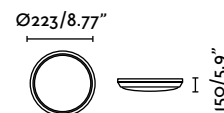

MERA [new]

Ceiling Lamp

LED

Ref.	70639	white blanco
Bulb	LED 25W 3000K 2000Lm CRI>80 incl.	
Materials	Die Cast Aluminium + Opal Polycarbonate Aluminio Inyectado + Policarbonato Opal	
V/Hz	220-240V / 50-60 Hz	
EEL	A	
Weight	0.85 kg / 1.87 lb	

+ info IP54 DRIVER





YEN

Ceiling Lamp

Ref.	70690  grey / gris
Bulb	1x E27 max 60W not incl. [LED 17452]
Materials	Die Cast Aluminium + Opal Polycarbonate / Aluminio Inyectado + Policarbonato Opal
V/Hz	100-240V / 50-60 Hz
EEL	A++ to E
Weight	1.24 kg / 2.73 lb

+ info  

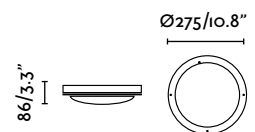

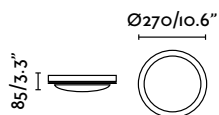

DAKRON

Ceiling Lamp

IP65

Ref.	70722		white blanco
Bulb	1xE27 max 40W not incl. [LED 17452]		
Materials	ABS + Opal Polycarbonate ABS + Policarbonato Opal		
V/Hz	100-240V / 50-60 Hz		
EEl	A++ to E		
Weight	0.92 kg / 2.03 lb		

+ info

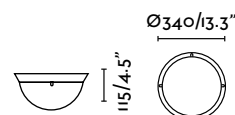

DAKYU

Ceiling Lamp

IP65

Ref.	70719		white blanco
Bulb	2xE27 40W not incl. [LED 17455]		
Materials	ABS + Opal Polycarbonate ABS + Policarbonato Opal		
V/Hz	100-240V / 50-60 Hz		
EEl	A++ to E		
Weight	1.5 kg / 3.31 lb		

+ info



IP65

LED

PIR

Ref.	70723		white blanco
Bulb	SMD LED 20W 3000K 1500Lm incl.		
Materials	ABS + Opal Polycarbonate ABS + Policarbonato Opal		
V/Hz	220-240V / 50-60 Hz		
EEl	A++ to A		
Weight	1.6 kg / 3.53 lb		

+ info

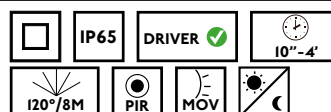



ARGOT

1/2 Wall Lamp

Ref.	71424	 rust brown marrón óxido
Bulb	1xE27 max 100W not incl. [LED 17453]	
Materials	Steel + Bubble Glass Acero + Cristal Burbuja	
V/Hz	100-240V / 50-60 Hz	
EEL	A++ to E	
Weight	1.7 kg / 3.75 lb	

+ info  

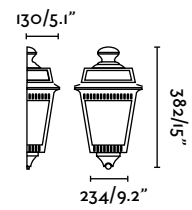

WALLY

Wall Lamp

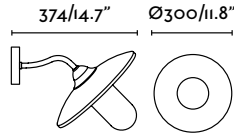

Ref.	74261	 rust brown marrón óxido
Bulb	1xE27 15W incl. [LED 17453]	
Materials	Metal + Transparent Glass Metal + Cristal Transparente	
V/Hz	220-240V / 50-60 Hz	
EEl	A+ to B	
Weight	1.59 kg / 3.51 lb	

+ info   

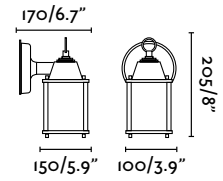

DADO

Wall Lamp

BULB INCLUDED
BOMBILLA INCLUIDA

Ref.	71606	 brown marrón
Bulb	1xE27 max 60W not incl. [LED 17453]	
Materials	Metal + Bubble Glass Metal + Cristal Burbuja	
V/Hz	220-240V / 50-60 Hz	
EEl	A++ to B	
Weight	0.88 kg / 1.94 lb	

+ info  

PARMA

1/2 Wall Lamp

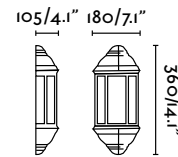

BULB INCLUDED
BOMBILLA INCLUIDA

Ref.	73315	 black negro
Bulb	1xE27 max 60W not incl. [LED 17453]	
Materials	Die Cast Aluminium + Transparent Polycarbonate Aluminio Inyectado + Policarbonato Transparente	
V/Hz	220-240V / 50-60 Hz	
EEl	A+ to B (Class B incl.)	
Weight	1.2 kg / 2.65 lb	



+ info  





CRIPTA

Wall Lamp

Ref.	71002		white blanco
	71003		black negro
	71004		grey gris

Bulb 1xE27 max 60W not incl. [LED 17455]

Materials PVC + Striped Glass
PVC + Cristal Rallado

V/Hz 100-240V / 50-60 Hz

EEL A++ to E

Weight 0.6 kg / 1.32 lb

+ info  

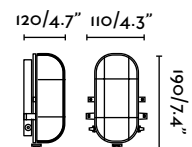

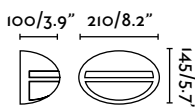

TERRA

Wall Lamp-p

Ref.	71554	 black negro
Bulb	1xE27 max 60W not incl. [LED 17454]	
Materials	Die Cast Aluminium + Opal Glass Aluminio Inyectado + Cristal Opal	
V/Hz	100-240V / 50-60 Hz	
EEL	A++ to E	
Weight	0.8 kg / 1.76 lb	

+ info  

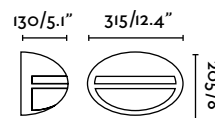

TERRA

Wall Lamp-g

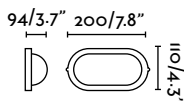

Ref.	71550	 white blanco
	71551	 black negro
Bulb	1xE27 max 100W not incl. [LED 17454]	
Materials	Die Cast Aluminium + Opal Glass Aluminio Inyectado + Cristal Opal	
V/Hz	100-240V / 50-60 Hz	
EEL	A++ to E	
Weight	1.8 kg / 3.97 lb	

+ info  



DERBY

Wall Lamp-p

Ref.	72000	 white blanco
	72001	 black negro
Bulb	1xE27 max 60W not incl. [LED 17452]	
Materials	Die Cast Aluminium + Translucent Glass Aluminio Inyectado + Cristal Translúcido	
V/Hz	100-240V / 50-60 Hz	
EEL	A++ to E	
Weight	0.7 kg / 1.54 lb	

+ info  

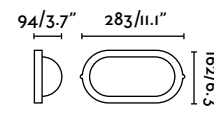

DERBY

Wall Lamp-g

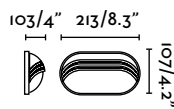

Ref.	72002	 white blanco
Bulb	1xE27 max 100W not incl. [LED 17452]	
Materials	Die Cast Aluminium + Translucent Glass Aluminio Inyectado + Cristal Translúcido	
V/Hz	100-240V / 50-60 Hz	
EEL	A++ to E	
Weight	1.5 kg / 3.31 lb	

+ info  



NONO

Wall Lamp-p

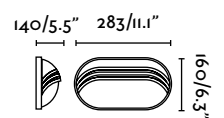

Ref.	71270		white blanco
	71271		black negro
Bulb	1xE27 max 60W not incl. [LED 17452]		
Materials	Die Cast Aluminium + Translucent Glass Aluminio Inyectado + Cristal Translúcido		
V/Hz	100-240V / 50-60 Hz		
EEL	A++ to E		
Weight	0.75 kg / 1.65 lb		

+ info  



NONO

Wall Lamp-g

Ref.	71260		white blanco
	71261		black negro
Bulb	1xE27 max 100W not incl. [LED 17454]		
Materials	Die Cast Aluminium + Translucent Glass Aluminio Inyectado + Cristal Translúcido		
V/Hz	100-240V / 50-60 Hz		
EEL	A++ to E		
Weight	1.6 kg / 3.53 lb		

+ info  

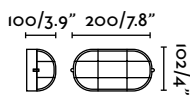

ESTAY

Wall Lamp-p

Ref.	72010		white blanco
	72011		black negro

Bulb 1xE27 max 60W not incl. [LED 17452]

Materials Die Cast Aluminium + Translucent Glass
Aluminio Inyectado + Cristal Translúcido

V/Hz 100-240V / 50-60 Hz

EEL A++ to E

Weight 0.72 kg / 1.59 lb

+ info

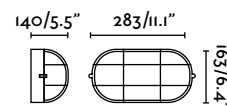

ESTAY

Wall Lamp-g

Ref.	72012		white blanco
	72013		black negro

Bulb 1xE27 max 100W not incl. [LED 17452]

Materials Die Cast Aluminium + Translucent Glass
Aluminio Inyectado + Cristal Translúcido

V/Hz 100-240V / 50-60 Hz

EEL A++ to E

Weight 1.48 kg / 3.26 lb

+ info

HF Until stock exhaustion
Hasta final de stock
Jusqu'à la fin de stock

HF

HF

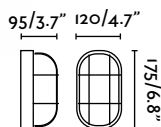

ÓVALO

Wall Lamp

Ref.	71000		white blanco
	71001		black negro

Bulb 1xE27 max 60W not incl. [LED 17452]

Materials Heat-Resistant ABS + Striped Glass
ABS Termoresistente + Cristal Rallado

V/Hz 100-240V / 50-60 Hz

EEL A++ to E

Weight 0.7 kg / 1.54 lb

+ info

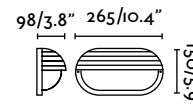

MIRTO

Wall Lamp

Ref.	72070		white blanco
	72071		black negro

Bulb 1xE27 max 60W not incl. [LED 17453]

Materials PVC
PVC

V/Hz 100-240V / 50-60 Hz

EEL A++ to E





Weight 0.6 kg / 1.32 lb

+ info



RONDO

Wall Lamp

Ref.	71010B	 white blanco
	71011N	 black negro
Bulb	1xE27 max 60W not incl. [LED 17452]	
Materials	Heat-Resistant ABS + Striped Glass ABS Termoresistente + Cristal Rallado	
V/Hz	100-240V / 50-60 Hz	
EEL	A++ to E	
Weight	0.93 kg / 2.05 lb	
+ info		

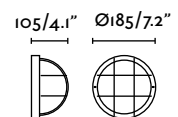

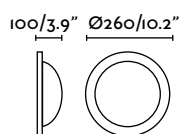

RADIO

Wall Lamp-g

Ref. **71500**  white
blanco

71501  black
negro



Bulb 1xE27 max 100W not incl. [LED 17453]

Materials Die Cast Aluminium + Translucent Glass
Aluminio Inyectado + Cristal Translúcido

V/Hz 100-240V / 50-60 Hz

EEL A++ to E

Weight 1.5 kg / 3.31 lb

+ info  

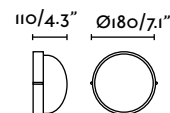

ASKOT

Wall Lamp

Ref. **72020**  white
blanco

Bulb 1xE27 max 100W not incl. [LED 17452]

Materials Die Cast Aluminium + Translucent Glass
Aluminio Inyectado + Cristal Translúcido

V/Hz 100-240V / 50-60 Hz

EEL A++ to E

Weight 0.87 kg / 1.92 lb

+ info  

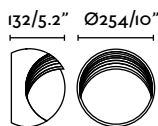

HEPTA

Wall Lamp

Ref. **71240**  white
blanco

71241  black
negro

Bulb 1xE27 max 100W not incl. [LED 17454]

Materials Die Cast Aluminium + Translucent Glass
Aluminio Inyectado + Cristal Translúcido

V/Hz 100-240V / 50-60 Hz

EEL A++ to E

Weight 1.6 kg / 3.53 lb

+ info  

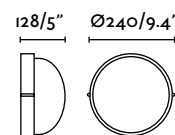

Ref. **72022**  white
blanco

Bulb 1xE27 max 100W not incl. [LED 17453]

Materials Die Cast Aluminium + Translucent Glass
Aluminio Inyectado + Cristal Translúcido

V/Hz 100-240V / 50-60 Hz

EEL A++ to E

Weight 1.7 kg / 3.75 lb

+ info  

More wall & ceiling lamps

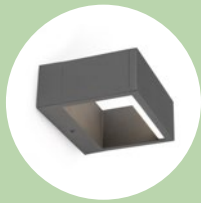

Alp
89



Beret
103

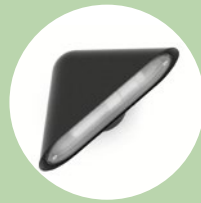

Bird
49



Blub'S
68



Boletus
87



Cross
81



Das
91



Datna
45



Ellen
101



Estoril
123



Gina
93



Giza
95



Grow
33



Klamp
58



Long
110



Mistu
77



Mitra
121



Moon
64



Muffin
73



Náutica
128



Neo
105



Newport
61



Onze
117



Paris
124



Plec
39



Rounder
99



Saga
97



Sail
63



Sentinel
57



Shelby
35



Sol
119



Steps
51



Tarraco
115



Tram
37



Wilma
107



Yak
55

Bastet	243	Nase <small>[new]</small>	231
Carter	245	Racing	245
Citrus	239	Salt <small>[new]</small>	257
Crosby	253	Sedna	233
Curtis	252	Store	237
Edel	257	Sula	241
Esca	247	Suria	255
Filter	237	Taro	253
Horus	235	Tecno -1	259
Indi	241	Tecno -6	263
Landai	240	Tecno -8	258
Led -15	259	Uve <small>[new]</small>	230
Led -16	259		
Led -18	249		
Led -18	251		
Led -19	261		
Lio	261		
Liso	247		
Metric	237		
Mini Carter	245		
Mini Contra	246		
Mini Geo	247		
Mini Racing	244		
Mysore	262		



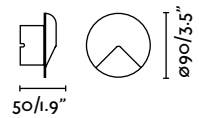

UVE [new]

LED

Recessed

Ref.	70397	dark grey gris oscuro
Bulb	SMD LED 2W 3000K 70Lm CRI>80 incl.	
Materials	Aluminium + Transparent Polycarbonate Aluminio + Policarbonato Transparente	
V/Hz	220-240V / 50-60 Hz	
EEL	A	
Weight	0.14 kg / 0.31 lb	

+ info



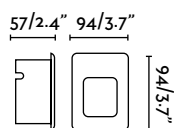

NASE -1 [new]

LED

Recessed

Ref.	70398	 dark grey gris oscuro
Bulb	SMD LED 4W 3000K 100Lm CRI>80 incl.	
Materials	Aluminium + Transparent Polycarbonate Aluminio + Policarbonato Transparente	
V/Hz	220-240V / 50-60 Hz	
EEL	A	
Weight	0.2 kg / 0.44 lb	

+ info      92x87x80

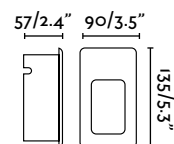

NASE -2 [new]

LED

Recessed

Ref.	70399	 dark grey gris oscuro
Bulb	SMD LED 4W 3000K 100Lm CRI>80 incl.	
Materials	Aluminium + Transparent Polycarbonate Aluminio + Policarbonato Transparente	
V/Hz	220-240V / 50-60 Hz	
EEL	A	
Weight	0.27 kg / 0.60 lb	

+ info      132x90x80







SEDNA -1

IP65 LED

Recessed

Ref.	70146	 dark grey gris oscuro
Bulb	SMD LED 1W 3000K 22Lm incl.	
Materials	Aluminium + Transparent Glass Aluminio + Cristal Transparente	
V/Hz	100-240V / 50-60 Hz	
EEL	A	
Weight	0.24 kg / 0.53 lb	

+ info



SEDNA -2

IP65 LED

Recessed

Ref.	70147	 dark grey gris oscuro
Bulb	SMD LED 3W 3000K 93Lm incl.	
Materials	Aluminium + Transparent Glass Aluminio + Cristal Transparente	
V/Hz	100-240V / 50-60 Hz	
EEL	A	
Weight	0.3 kg / 0.66 lb	

+ info

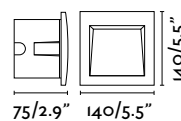

SEDNA -3

IP65 LED

Recessed

Ref.	70148	 dark grey gris oscuro
Bulb	SMD LED 3W 3000K 122Lm incl.	
Materials	Aluminium + Transparent Glass Aluminio + Cristal Transparente	
V/Hz	100-240V / 50-60 Hz	
EEL	A	
Weight	0.51 kg / 1.12 lb	

+ info

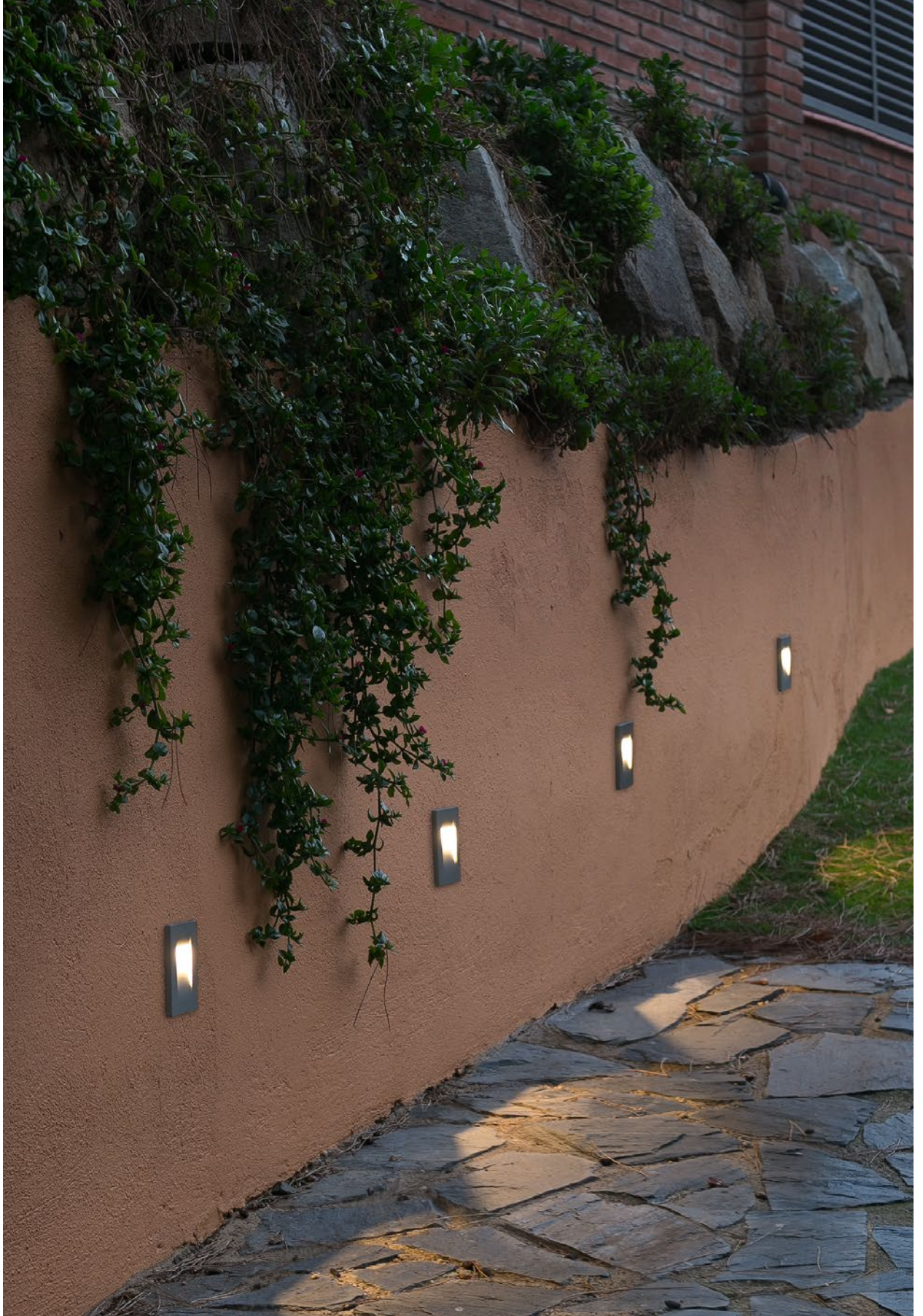

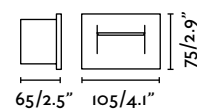
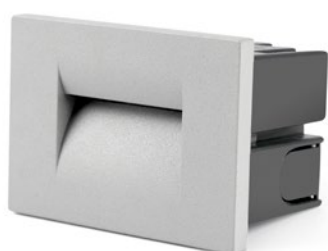
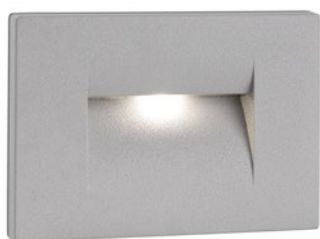

HORUS -1

IP65 LED

Recessed

Ref.	70154	 grey gris
Bulb	SMD LED 4W 3000K 50Lm CRI>80 incl.	
Materials	Die Cast Aluminium + Polycarbonate Aluminio Inyectado + Policarbonato	
V/Hz	100-240V / 50-60 Hz	
EEL	B	
Weight	0.34 kg / 0.75 lb	

+ info

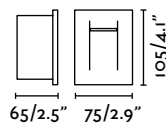

HORUS -2

IP65 LED

Recessed

Ref.	70155	 grey gris
Bulb	SMD LED 4W 3000K 55Lm CRI>80 incl.	
Materials	Die Cast Aluminium + Polycarbonate Aluminio Inyectado + Policarbonato	
V/Hz	100-240V / 50-60 Hz	
EEL	B	
Weight	0.36 kg / 0.79 lb	

+ info

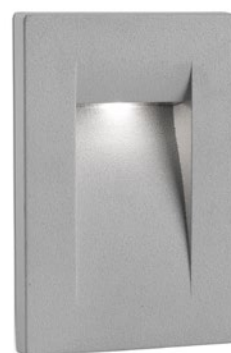



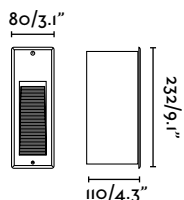

METRIC

IP65

Recessed

Ref.	71375	grey gris
Bulb	1xG9 28W not incl. [LED 17444]	
Materials	Die Cast Aluminium + Tempered Glass Aluminio Inyectado + Cristal Templado	
V/Hz	220-240V / 50-60 Hz	
EEL	A++ to E	
Weight	1 kg / 2.20 lb	

+ info

FILTER

IP65 LED

Recessed

Ref.	70450	grey gris	2700K
	70460	grey gris	6000K
Bulb	LED 2W 75Lm incl.		
Materials	PVC + Die Cast Aluminium + Tempered Glass PVC + Aluminio Inyectado + Cristal Templado		
V/Hz	100-240V / 50-60 Hz		
EEL	A		
Weight	0.1 kg / 0.22 lb		

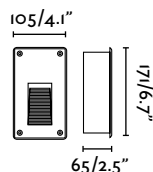

+ info

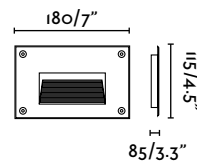

STORE

IP65 LED

Recessed

Ref.	70451	grey gris
Bulb	LED 2W 2700K 90Lm incl.	
Materials	PVC + Die Cast Aluminium + Tempered Glass PVC + Aluminio Inyectado + Cristal Templado	
V/Hz	100-240V / 50-60 Hz	
EEL	A	
Weight	1 kg / 2.20 lb	

+ info



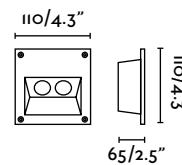

CITRUS -2

IP65 LED

Recessed

Ref.	70561	 dark grey gris oscuro
Bulb	HIGH POWER LED 3W 4000K 120Lm incl.	
Materials	Die Cast Aluminium + Tempered Glass Aluminio Inyectado + Cristal Templado	
V/Hz	100-240V / 50-60 Hz	
EEL	A	
Weight	0.53 kg / 1.17 lb	

+ info       

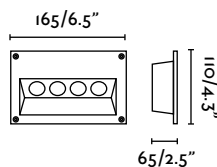

CITRUS -4

IP65 LED

Recessed

Ref.	70562	 dark grey gris oscuro
Bulb	HIGH POWER LED 4W 4000K 240Lm incl.	
Materials	Die Cast Aluminium + Tempered Glass Aluminio Inyectado + Cristal Templado	
V/Hz	100-240V / 50-60 Hz	
EEL	A	
Weight	0.72 kg / 1.59 lb	

+ info        





LANDAI

IP65 LED

Recessed

Ref. 70400  dark grey / gris oscuro

Bulb SMD LED 1W 4000K 75Lm incl.

Materials Die Cast Aluminium + Transparent Polycarbonate / Aluminio Inyectado + Policarbonato Transparente

V/Hz 100-240V / 50-60 Hz

EEL A++ to A

Weight 0.6 kg / 1.32 lb

+ info



IP65

DRIVER 



 237x97x92



 120°

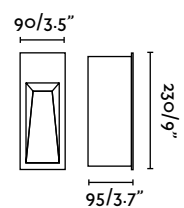

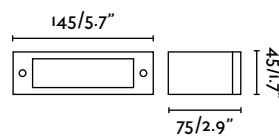



INDI - 1

LED

Recessed

Ref.	70632 ● dark grey / gris oscuro
Bulb	LED 1W 6500K 48Lm incl.
Materials	Die Cast Aluminium + Transparent PVC / Aluminio Inyectado + PVC Transparente
V/Hz	220-240V / 50 Hz
EEl	A++ to A
Weight	0.38 kg / 0.84 lb

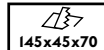
+ info    

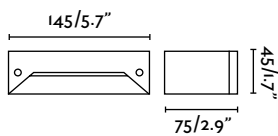

INDI - 2

LED

Recessed

Ref.	70633 ● dark grey / gris oscuro
Bulb	LED 1W 6500K 48Lm incl.
Materials	Die Cast Aluminium + Transparent PVC / Aluminio Inyectado + PVC Transparente
V/Hz	220-240V / 50 Hz
EEl	A++ to A
Weight	0.37 kg / 0.82 lb

+ info     

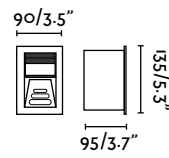







SULA

IP65 LED

Recessed

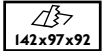
Ref.	70401 ● dark grey / gris oscuro
Bulb	SMD LED 1W 4000K 75Lm incl.
Materials	Die Cast Aluminium + Transparent Polycarbonate / Aluminio Inyectado + Policarbonato Transparente
V/Hz	220-240V / 50-60 Hz
EEl	A++ to A
Weight	0.45 kg / 0.99 lb

+ info     
 



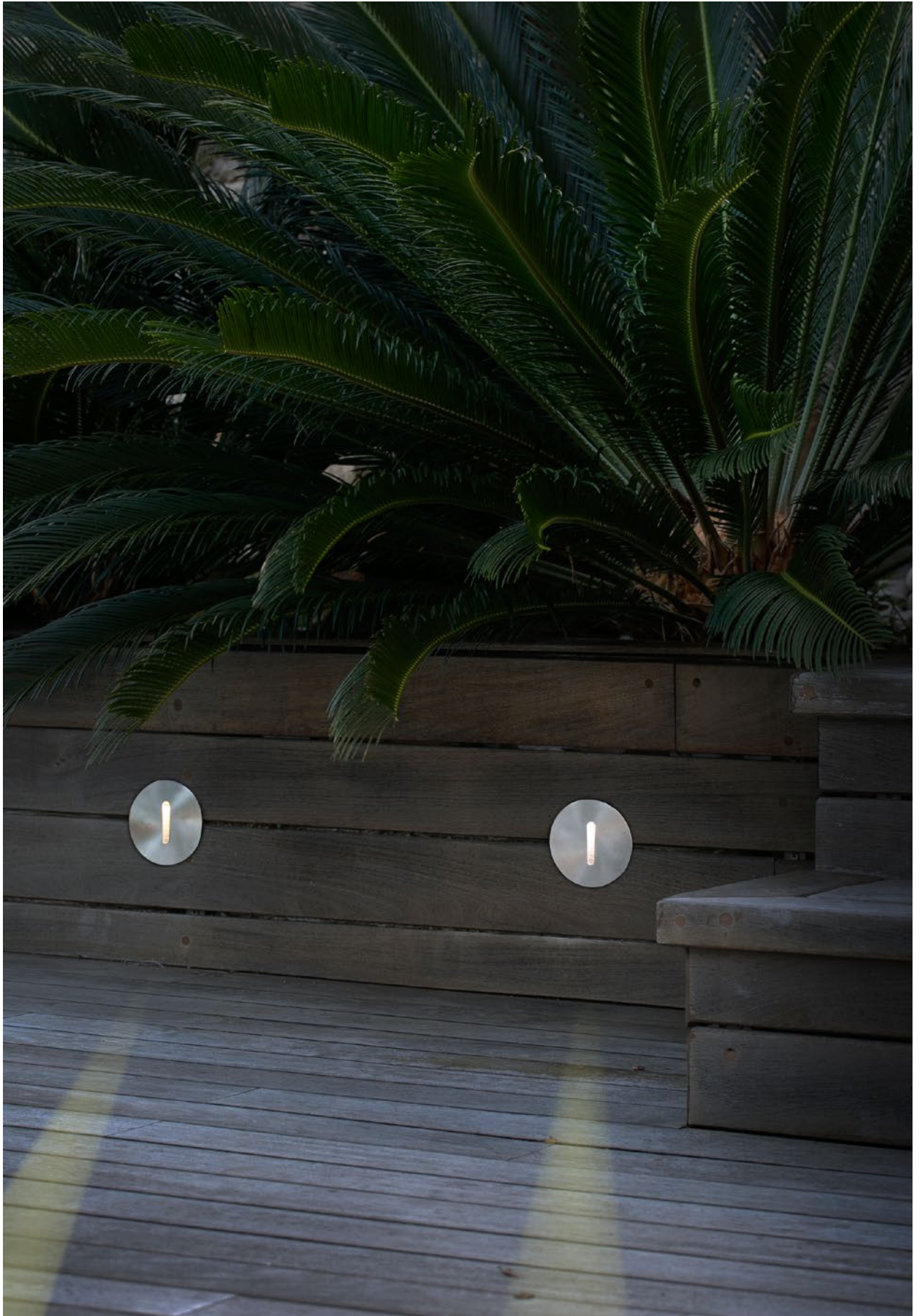

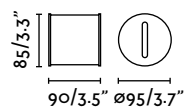



BASTET

IP65 INOX 304 LED

Recessed

Ref.	70152	 matt nickel níquel mate
Bulb	SMD LED 4W 3000K 25Lm CRI>80 incl.	
Materials	304 Stainless Steel + Glass Acero Inoxidable 304 + Cristal	
V/Hz	100-240V / 50 Hz	
EEl	B	
Weight	0.38 kg / 0.84 lb	

+ info



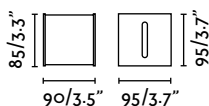



BASTET

IP65 INOX 304 LED

Recessed

Ref.	70153	 matt nickel níquel mate
Bulb	SMD LED 4W 3000K 25Lm CRI>80 incl.	
Materials	304 Stainless Steel + Glass Acero Inoxidable 304 + Cristal	
V/Hz	100-240V / 50 Hz	
EEl	B	
Weight	0.42 kg / 0.93 lb	

+ info



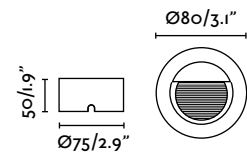







MINI RACING

Recessed

LED

Ref.	70403	 dark grey gris oscuro
Bulb	SMD LED 1,2W 4000K 30Lm incl.	
Materials	Die Cast Aluminium + Transparent PVC Aluminio Inyectado + PVC Transparente	
V/Hz	100-240V / 50-60 Hz	
EEL	A	
Weight	0.1 kg / 0.22 lb	

+ info

**MINI CARTER**

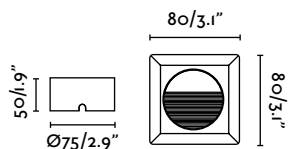
LED

Recessed

Ref.	70402	 dark grey gris oscuro
Bulb	SMD LED 1,2W 4000K 30Lm incl.	
Materials	Die Cast Aluminium + Transparent PVC Aluminio Inyectado + PVC Transparente	
V/Hz	100-240V / 50-60 Hz	
EEL	A to B	
Weight	0.2 kg / 0.44 lb	

+ info

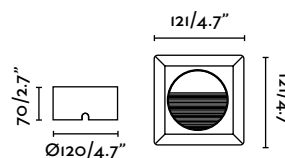
**CARTER**

IP65

LED

Recessed

Ref.	70607	 grey gris
Bulb	SMD LED 1,4W 4000K 60Lm incl.	
Materials	Die Cast Aluminium + Transparent PVC Aluminio Inyectado + PVC Transparente	
V/Hz	100-240V / 50-60 Hz	
EEL	A++	
Weight	0.4 kg / 0.88 lb	

+ info

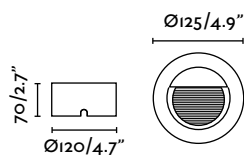
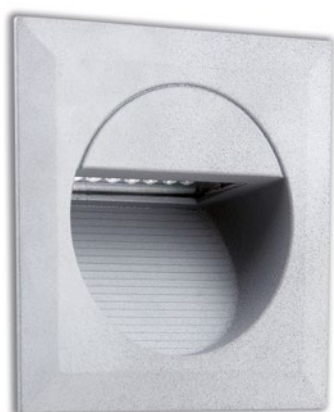
**RACING**

IP65

LED

Recessed

Ref.	70606	 grey gris
Bulb	SMD LED 1,4W 4000K 60Lm incl.	
Materials	Die Cast Aluminium + Transparent PVC Aluminio Inyectado + PVC Transparente	
V/Hz	220-240V / 50-60 Hz	
EEL	A++ to A	
Weight	0.4 kg / 0.88 lb	

+ info



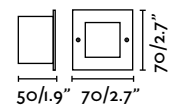



MINI CONTRA

INOX 304 | LED

Recessed

Ref.	70600		matt nickel níquel mate	8000K
	71354		matt nickel níquel mate	3000K
Bulb	LED 0,5W 30Lm incl.			
Materials	304 Stainless Steel + Translucent Glass + PVC Acero Inoxidable 304 + Cristal Translúcido + PVC			
V/Hz	220-240V / 50-60 Hz			
EEl	A			
Weight	0.2 kg / 0.44 lb			

+ info

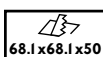

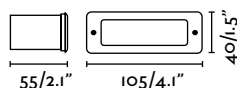

MINI GEO

Recessed

INOX 304 LED

Ref.	71355	 matt nickel níquel mate	3000K
Bulb	LED 0,7W 40Lm incl.		
Materials	304 Stainless Steel + Translucent Glass + PVC Acero Inoxidable 304 + Cristal Translúcido + PVC		
V/Hz	220-240V / 50-60 Hz		
EEL	A		
Weight	0.2 kg / 0.44 lb		

+ info

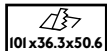

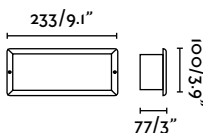
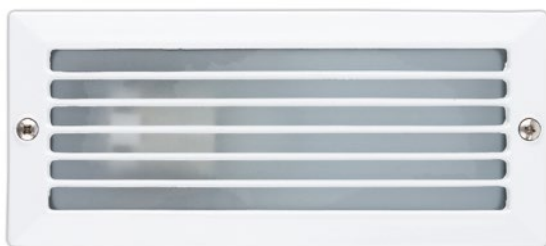

101x36.3x50.6



LISO

Recessed

Ref.	71490	 white blanco	
	71491	 black negro	
Bulb	1xE27 max 40W not incl. [LED 17453]		
Materials	Die Cast Aluminium + Translucent Polycarbonate Aluminio Inyectado + Policarbonato Translúcido		
V/Hz	100-240V / 50-60 Hz		
EEL	A++ to E		
Weight	0.57 kg / 1.26 lb		

+ info



230x89

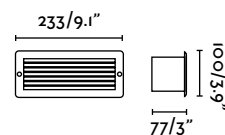

ESCA

Recessed

Ref.	71480	 white blanco	
	71481	 black negro	
Bulb	1xE27 max 40W not incl. [LED 17453]		
Materials	Metal + Translucent Glass Metal + Cristal Translúcido		
V/Hz	100-240V / 50-60 Hz		
EEL	A++ to E		
Weight	0.6 kg / 1.32 lb		

+ info



230x89



Recessed box for LISO and ESCA
Caja de empotrar para LISO y ESCA 

71482  dark grey
gris oscuro

PVC
PVC
0.38 kg / 0.84 lb

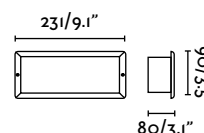

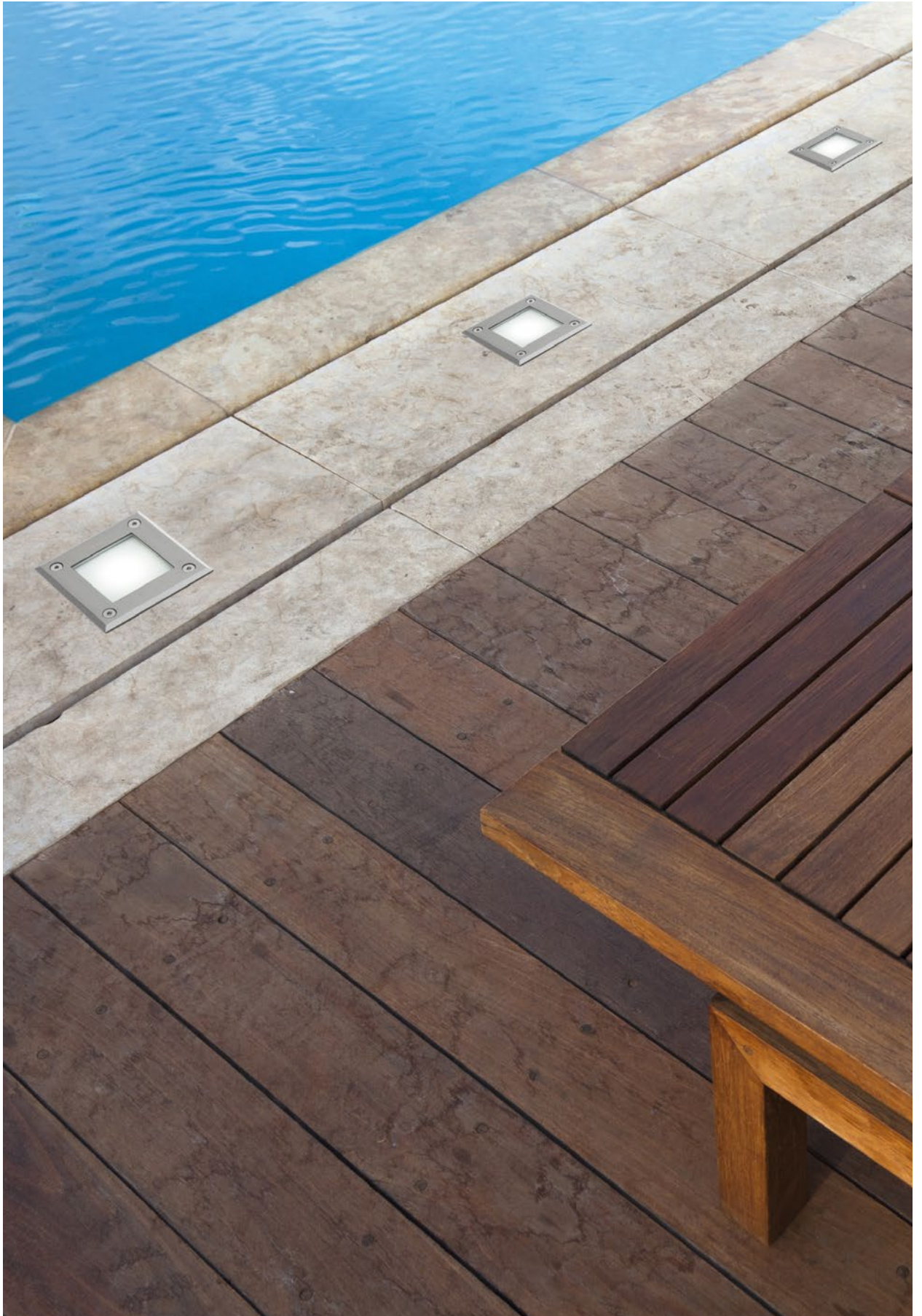

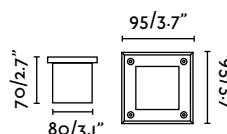



LED - I8

Recessed

IP67 INOX 316 LED

Ref.	71497N		matt nickel níquel mate	6000K	180Lm	[new]
	71499N		matt nickel níquel mate	3000K	160Lm	
Bulb	HIGH POWER LED 3W 160Lm incl.					
Materials	316 Stainless Steel + Die Cast Aluminium + Transparent Glass + Polycarbonate Acero Inoxidable 316 + Aluminio Inyectado + Cristal Transparente + Policarbonato					
V/Hz	100-240V / 50-60 Hz					

IP67 INOX 304 LED

Ref.	71497		matt nickel níquel mate	6000K		HF
Bulb	HIGH POWER LED 3W 160Lm incl.					
Materials	304 Stainless Steel + Die Cast Aluminium + Transparent Glass + Polycarbonate Acero Inoxidable 304 + Aluminio Inyectado + Cristal Transparente + Policarbonato					
V/Hz	220-240V / 50-60 Hz					
EEl	A++ to A					
Weight	0.81 kg / 1.79 lb					

+ info













See electrical connections pag. 288
Ver conexiones pág. 288

HF **Until stock exhaustion**
Hasta final de stock
Jusqu'à la fin de stock

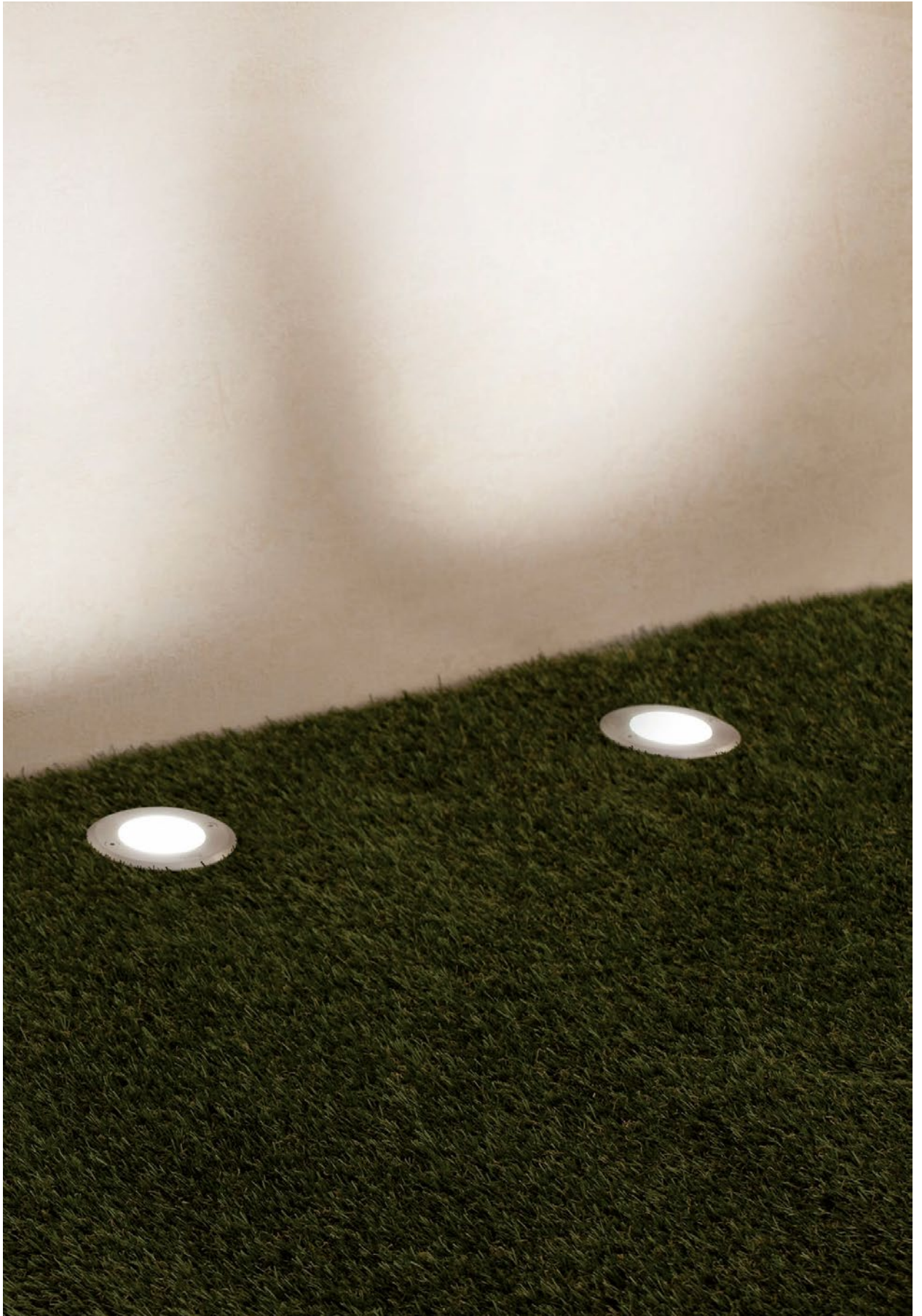
 **Very important: see drainage specifications and IP for recesseds, pag. 299**
Consulte las especificaciones de drenaje e IP para empotrables de suelo, pág. 299
Très important: voir spécifications pour le drainage et IP de l'encastrables, pag. 299

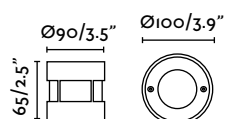



LED - I8

IP67 INOX 316 LED

Recessed

Ref.	71496N		matt nickel níquel mate	6000K	180Lm	[new]
	71498N		matt nickel níquel mate	3000K	160Lm	
Bulb	HIGH POWER LED 3W 160Lm incl.					
Materials	316 Stainless Steel + Die Cast Aluminium + Transparent Glass + Polycarbonate Acero Inoxidable 316 + Aluminio Inyectado + Cristal Transparente + Policarbonato					
V/Hz	100-240V / 50-60 Hz					
EEL	A++ to A					
Weight	0.81 kg / 1.79 lb					

+ info        

See electrical connections pag. 288
Ver conexiones pág. 288





Very important: see drainage specifications and IP for recesseds, pag. 299
Consulte las especificaciones de drenaje e IP para empotrables de suelo, pág. 299
Très important: voir spécifications pour le drainage et IP de l'encastrables, pag. 299



CURTIS

IP67 INOX 316 LED

Recessed

Ref.	70462N		matt nickel níquel mate	3000K
	70463N		matt nickel níquel mate	6000K

Bulb HIGH POWER LED 2W 77Lm incl.







Materials 316 Stainless Steel + Aluminium + Tempered Glass + ABS
Acero Inoxidable 316 + Aluminio + Cristal Templado + ABS

V/Hz 100-240V / 50-60 Hz

EEL A+

Weight 0.36 kg / 0.79 lb

+ info



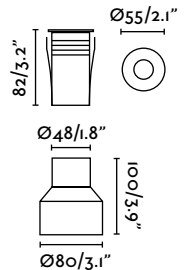

CROSBY

IP67

INOX 316

LED

Recessed

Ref.	70458N		matt nickel níquel mate	6000K 120-240V	85Lm
	70459N		matt nickel níquel mate	3000K 100-240V	77Lm

Bulb HIGH POWER LED 2W incl.

Materials 304 Stainless Steel + Die Cast Aluminium + Tempered Glass + ABS

Acero Inoxidable 304 + Aluminio Inyectado + Cristal Templado + ABS

V/Hz 100-240V / 50-60 Hz

EEL A+

Weight 1.1 kg / 2.43 lb

+ info       

Ref.	70453		matt nickel níquel mate	3000K	77Lm
------	--------------	---	----------------------------	-------	------

Materials 304 Stainless Steel + Die Cast Aluminium + Tempered Glass + ABS

Acero Inoxidable 304 + Aluminio Inyectado + Cristal Templado + ABS

V/Hz 24V

EEL A

Weight 0.34 kg / 0.75 lb

+ info      

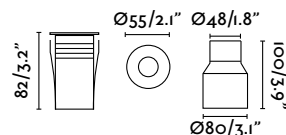

TARO

IP67

INOX 316

LED

Recessed

Ref.	70449		matt nickel níquel mate
------	--------------	---	----------------------------

Bulb COB LED 7W 3000K 280Lm CRI>80 incl.

Materials 316 Stainless Steel + Glass
Acero Inoxidable 316 + Cristal

V/Hz 100-240V / 50-60 Hz

EEL A

Weight 0.58 kg / 1.28 lb

+ info     
  

See electrical connections pag. 288
Ver conexiones pág. 288



Very important: see drainage specifications and IP for recesseds, pag. 299
Consulte las especificaciones de drenaje e IP para empotrables de suelo, pág. 299
Très important: voir spécifications pour le drainage et IP de l'encastrables, pag. 299



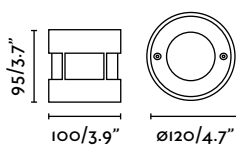

SURIA -3

Recessed

IP67 INOX 316 LED

Ref.	70592N		matt nickel níquel mate		[new]
	70588		matt nickel níquel mate		[new]
Bulb	COB LED 3W 3000K 300Lm incl.				
Materials	Aluminium + 316 Stainless Steel + Glass Aluminio + Acero Inoxidable 316 + Cristal				
V/Hz	100-240V / 50-60 Hz				
EEL	A++				
Weight	0.67 kg / 1.48 lb				



+ info

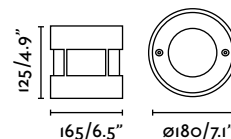

SURIA -12

Recessed

IP67 INOX 316 LED

Ref.	70593N		matt nickel níquel mate		[new]
	70589		matt nickel níquel mate		[new]
Bulb	COB LED 12W 3000K 1200Lm incl.				
Materials	Aluminium + 316 Stainless Steel Aluminio + Acero Inoxidable 316				

IP67 INOX 304 LED



Ref.	70593		matt nickel níquel mate		HF
Bulb	COB LED 12W 3000K 1200Lm incl.				
Materials	304 Stainless Steel + Glass Acero Inoxidable 304 + Cristal				
V/Hz	100-240V / 50-60 Hz				
EEL	A				
Weight	1.94 kg / 4.28 lb				

+ info

HF Until stock exhaustion
Hasta final de stock
Jusqu'à la fin de stock

See electrical connections pag. 288
Ver conexiones pág. 288



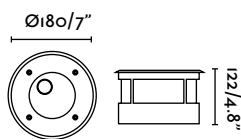

SALT [new]

Recessed ASIMÉTRICO

IP67 LED

Ref.	70591		matt nickel níquel mate
Bulb	COB LED 9W 3000K 900 Lm CRI>80 incl.		
Materials	316 Stainless Steel + Transparent Glass Acero Inoxidable 316 + Cristal Transparente		
V/Hz	100-240V / 50-60 Hz		
EEL	A		
Weight	1.8 kg / 3.97 lb		

+ info

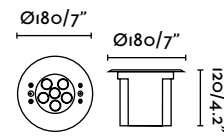

EDEL

Recessed

IP68 INOX LED

Ref.	70455		matt nickel níquel mate	4000K	900Lm
	70456		matt nickel níquel mate		rgb rgb
Bulb	HIGH POWER LED 18W incl.				
Materials	316 Stainless Steel + Transparent Glass + PVC Acero Inoxidable 316 + Cristal Transparente + PVC				
V/Hz	24Vdc / 50-60 Hz				
EEL	A				
Weight	1.65 kg / 3.64 lb				

+ info



VERY IMPORTANT: TO BE USED ONLY UNDERWATER
IMPORTANTE: USO EXCLUSIVO SÓLO BAJO EL AGUA

RGB accessories

Accesorios RGB

- 46067** Fuente de alimentación 24V 20W
- 70472** Controlador LED RGB MASTER 24V 72W
- 70474** Control remoto IR RGB
- 70475** Receptor IR RGB
- 70476** Controlador LED RGB SLAVE 24V 72W

See electrical connections pag. 288
Ver conexiones pág. 288

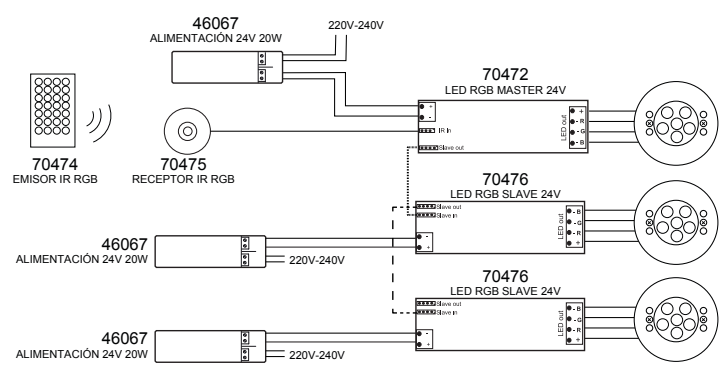



See electrical connections pag. 288
Ver conexiones pág. 288



TECNO - 8

IP67

INOX

ANTI GLARE
ANTIDESLUMBRANTE

Recessed

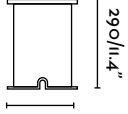
Ref.	71506	 matt nickel níquel mate	HF
Bulb	1 x AR III max 50W not incl. [17512]		Ø210/8.2"
Materials	Polycarbonate + Stainless Steel + Die Cast Aluminium + Transparent Glass Policarbonato + Acero Inoxidable + Aluminio Inyectado + Cristal Transparente		
V/Hz	220-240V / 50-60 Hz		 290/11.4"
EEL	A++ to E		
Weight	3.72 kg / 8.20 lb		Ø200/7.8"

+ info



HF Until stock exhaustion
Hasta final de stock
Jusqu'à la fin de stock

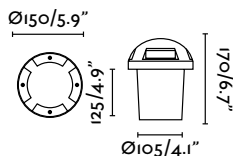







LED -15

IP67 LED

Recessed

Ref.	70544  grey / gris
Bulb	LED 4W 6000K 10Lm incl.
Materials	Die Cast Aluminium / Aluminio Inyectado
V/Hz	220-240V / 50-60 Hz
EEL	A
Weight	1.05 kg / 2.31 lb

+ info       

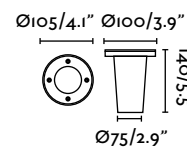

LED -16

IP67 INOX LED

Recessed

Ref.	70545  matt nickel / níquel mate
Bulb	LED 2W 6500K 30Lm incl.
Materials	Stainless Steel + PVC + Transparent Glass / Acero Inoxidable + PVC + Cristal Transparente
V/Hz	100-240V / 50-60 Hz
EEL	A
Weight	0.63 kg / 1.39 lb

+ info      



TECNO -1

IP67 INOX

Recessed

Ref.	71483  matt nickel / níquel mate
Bulb	1x E27 max 60W not incl. [LED 17454]
Materials	Stainless Steel + Die Cast Aluminium + Transparent Glass / Acero Inoxidable + Aluminio Inyectado + Cristal Transparente
V/Hz	100-240V / 50-60 Hz
EEL	A++ to E
Weight	2.13 kg / 4.70 lb

+ info       

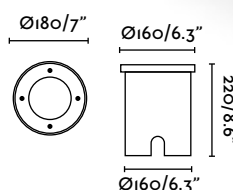

See electrical connections pag. 288 / Ver conexiones pag. 288



Very important: see drainage specifications and IP for recesseds, pag. 299 / Consulte las especificaciones de drenaje e IP para empotrables de suelo, pag. 299 / Très important: voir spécifications pour le drainage et IP de l'encastrables, pag. 299



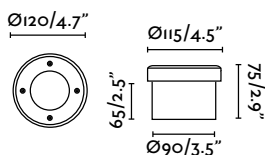

LIO

Recessed

IP67 INOX

Ref.	71495	matt nickel níquel mate
Bulb	1xGX53 9W 4000K 330Lm incl. [LED 17340]	
Materials	Stainless Steel + Transparent Glass Acero Inoxidable + Cristal Transparente	
V/Hz	100-240V / 50-60 Hz	
EEL	A++	
Weight	0.66 kg / 1.46 lb	



+ info

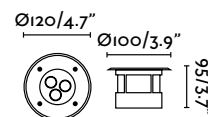

LED -19

Recessed

IP67 LED

Ref.	70596	matt nickel níquel mate
Bulb	LED 3W 3000K 2 10Lm incl.	
Materials	Die Cast Aluminium + Transparent Glass Aluminio Inyectado + Cristal Transparente	
V/Hz	100-240V / 50-60 Hz	
EEL	A	
Weight	0.78 kg / 1.72 lb	



+ info

See electrical connections pag. 288
Ver conexiones pág. 288



MYSORE

IP67

Recessed

Ref.	71476	 matt nickel níquel mate
Bulb	1xT5 G5 24W not incl.	
Materials	Die Cast Aluminium + Stainless Steel + Transparent Glass Aluminio Inyectado + Acero Inoxidable + Cristal Transparente	
V/Hz	220-240V / 50-60 Hz	
EEI	A++ to E	
Weight	5.83 kg / 12.85 lb	

+ info

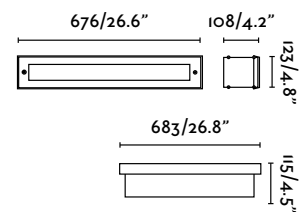

See electrical connections pag. 288
Ver conexiones pág. 288

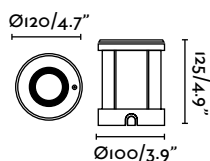
**TECNO -6**

IP67 INOX 316

Recessed

Ref. 71489N  matt nickel
níquel mate

Bulb 1xGU10 max 50W not incl. [LED 17324]

Materials 316 Stainless Steel + Transparent Glass
Acero Inoxidable 316 + Cristal Transparente

V/Hz 100-240V / 50-60 Hz

EEL A++

Weight 0.79 kg / 1.74 lb

+ info

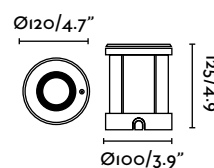

[new]

**TECNO -6**

IP67 INOX 316

Recessed

Ref. 71488N  matt nickel
níquel mate

Bulb 1xGU10 max 11W not incl. [LED 17317]

Materials 316 Stainless Steel + Transparent Glass
Acero Inoxidable 316 + Cristal Transparente

IP67 INOX 304

Ref. 71488  matt nickel
níquel mate

Bulb 1xGU10 max 11W not incl. [LED 17317]

Materials 304 Stainless Steel + Transparent Glass
Acero Inoxidable 304 + Cristal Transparente

V/Hz 100-240V / 50-60 Hz

EEL A++

Weight 0.81 kg / 1.79 lb

+ info



[new]

HF

HF

Until stock exhaustion
Hasta final de stock
Jusqu'à la fin de stock

See electrical connections pag. 288
Ver conexiones pág. 288



Very important: see drainage specifications and IP for recesseds, pag. 299
Consulte las especificaciones de drenaje e IP para empotrables de suelo, pág. 299
Très important: voir spécifications pour le drainage et IP de l'encastrables, pag. 299

Alfa <small>[new]</small>	266
Apolo	275
Aran	271
Aton	271
Balder	277
Flux <small>[new]</small>	270
Garten -1	279
Garten -2	281
Garten -4	279
Garten -5	279
Gera	271
Nava	274
Onda	275
Pola	281
Project	268
Seth-28 <small>[new]</small>	278
Seth-60	278
Sobek	277
Toni <small>[new]</small>	276
Tono	281
Toran -1	273
Toran -2	273



projectors
& spikers

Alfa [new]

Design: Àlex&Manel
Llusçà



Without detracting from its luminous efficiency, we have done mobility and we have given dress this LED spotlight.





[new]

IP65 LED

Projector

Ref.	70025	 dark grey gris oscuro
Bulb	COB LED 15W 3000K I077Lm incl.	
Materials	Die Cast Aluminium + Transparent Glass Aluminio Inyectado + Cristal Transparente	
V/Hz	100-240V / 50-60 Hz	
EEL	A++ to A	
Weight	0.9 kg / 1.98 lb	

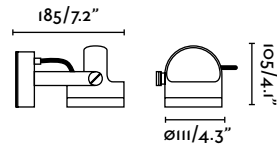

+ info     

Project

Design: Àlex&Manel
Llusçà



M*ade in
cast aluminum and
available in two sizes
and different finishes.
It is swivel both vertical-
ly and horizontally.*



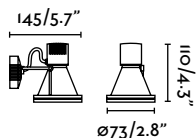

IP65 ORIENTABLE

Projector	
Ref.	71383 ● grey gris
	71390 ● dark grey gris oscuro
Bulb	1xGU10 max 50W not incl. [LED 17317]
Materials	Die Cast Aluminium + Transparent Glass Aluminio Inyectado + Cristal Transparente
V/Hz	100-240V / 50-60 Hz
EEL	A++ to E
Weight	0.58 kg / 1.28 lb

+ info

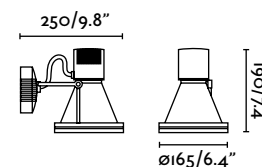
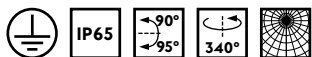

IP65 ORIENTABLE

Projector	
Ref.	71382 ● grey gris
	71389 ● dark grey gris oscuro
Bulb	1xE27 PAR 38 20W not incl. [LED 17400]
Materials	Die Cast Aluminium + Transparent Glass Aluminio Inyectado + Cristal Transparente
V/Hz	100-240V / 50-60 Hz
EEL	A++ to B
Weight	1.6 kg / 3.53 lb

+ info



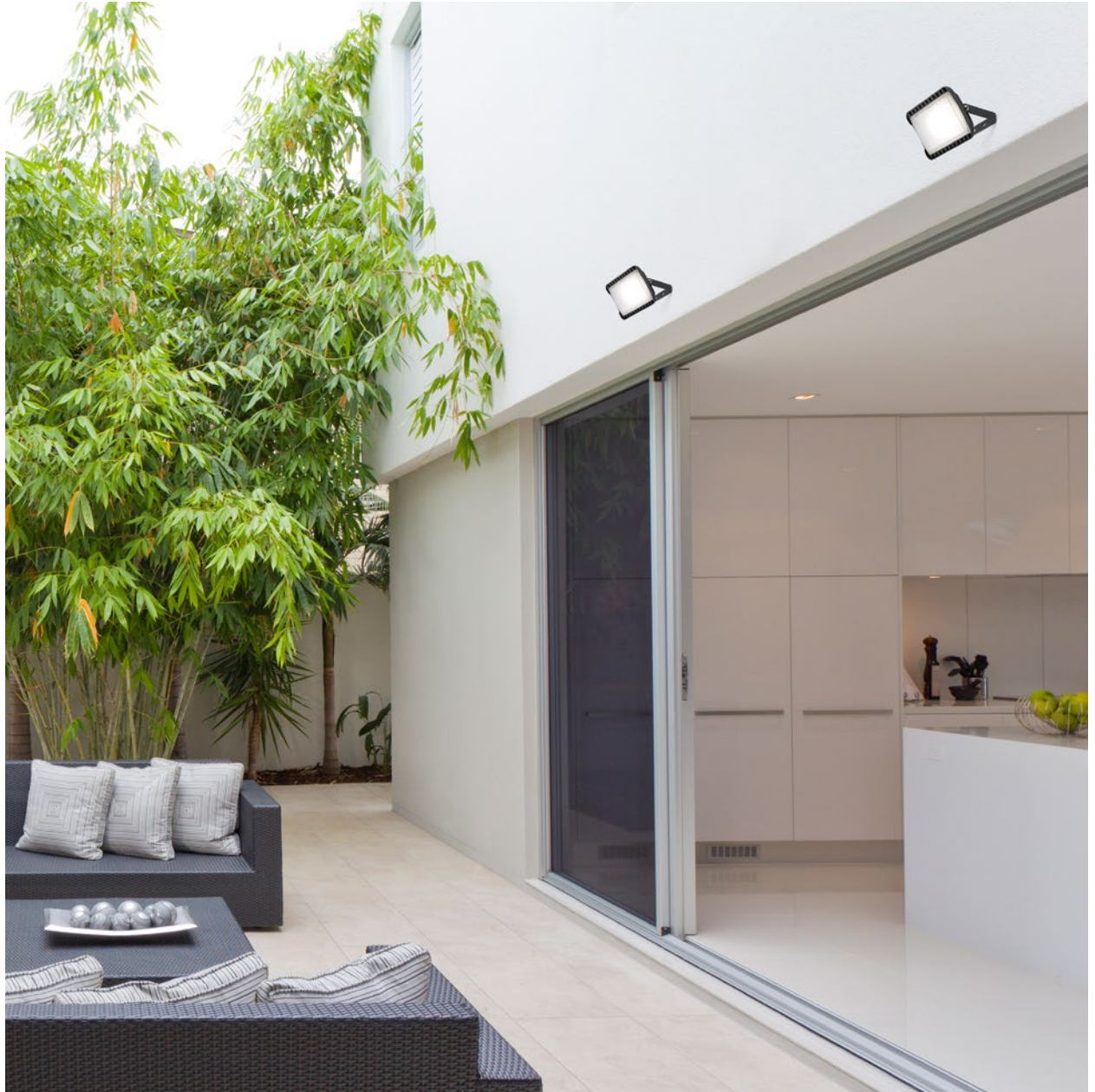

FLUX [new]

LED

Projector

Ref.	70649	● dark grey gris oscuro
Bulb	SMD LED 10W 3000K 450Lm CRI>80 incl.	
Materials	Aluminium + Opal Polycarbonate Aluminio + Policarbonato Opal	
V/Hz	220-240V / 50-60 Hz	
EEL	A++ to A	
Weight	0.2 kg / 0.44 lb	

+ info

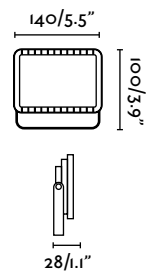

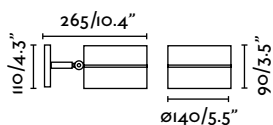

ATON

Projector

IP65 LED

Ref.	70150 ● dark grey / gris oscuro
Bulb	COB LED 15W 4000K 1125Lm CRI>80 incl.
Materials	Die Cast Aluminium + Translucent Glass / Aluminio Inyectado + Cristal Translúcido
V/Hz	100-240V / 50-60 Hz
EEL	A
Weight	1.94 kg / 4.28 lb

+ info      

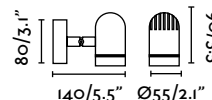
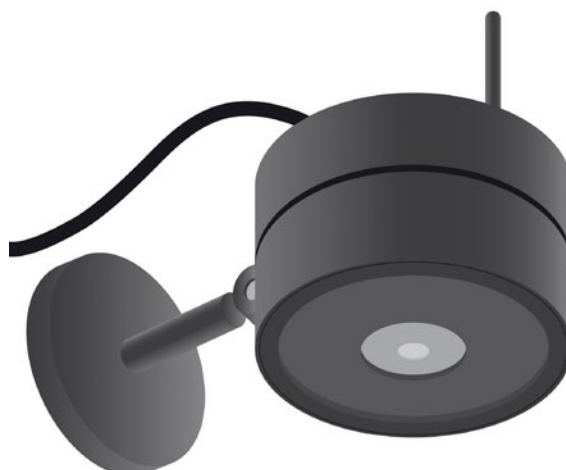

GERA

Projector

LED

Ref.	70138 ● dark grey / gris oscuro
Bulb	SMD LED 5W 4000K 280Lm incl.
Materials	Die Cast Aluminium + Transparent Glass / Aluminio Inyectado + Cristal Transparente
V/Hz	220-240V / 50-60 Hz
EEL	A++ to A
Weight	0.6 kg / 1.32 lb

+ info      

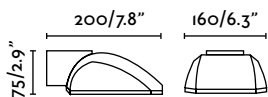

ARAN

Projector

IP65 LED

Ref.	70137 ● dark grey / gris oscuro
Bulb	SMD LED 17W 4000K 1440Lm incl.
Materials	Die Cast Aluminium + Transparent Glass / Aluminio Inyectado + Cristal Transparente
V/Hz	220-240V / 50-60 Hz
EEL	A
Weight	1.2 kg / 2.65 lb

+ info      





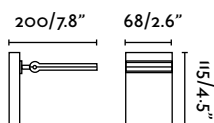

TORAN -1

Projector

LED

Ref.	70139	 dark grey gris oscuro
Bulb	SMD LED 5W 4000K 345Lm incl.	
Materials	Die Cast Aluminium + Transparent Glass Aluminio Inyectado + Cristal Transparente	
V/Hz	220-240V / 50-60 Hz	
EEL	A++ to A	
Weight	0.6 kg / 1.32 lb	

+ info       

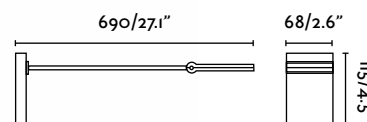

TORAN -2

Projector

LED

Ref.	70140	 dark grey gris oscuro
Bulb	SMD LED 5W 4000K 345Lm incl.	
Materials	Die Cast Aluminium + Transparent Glass Aluminio Inyectado + Cristal Transparente	
V/Hz	220-240V / 50-60 Hz	
EEL	A++ to A	
Weight	0.8 kg / 1.76 lb	

+ info       

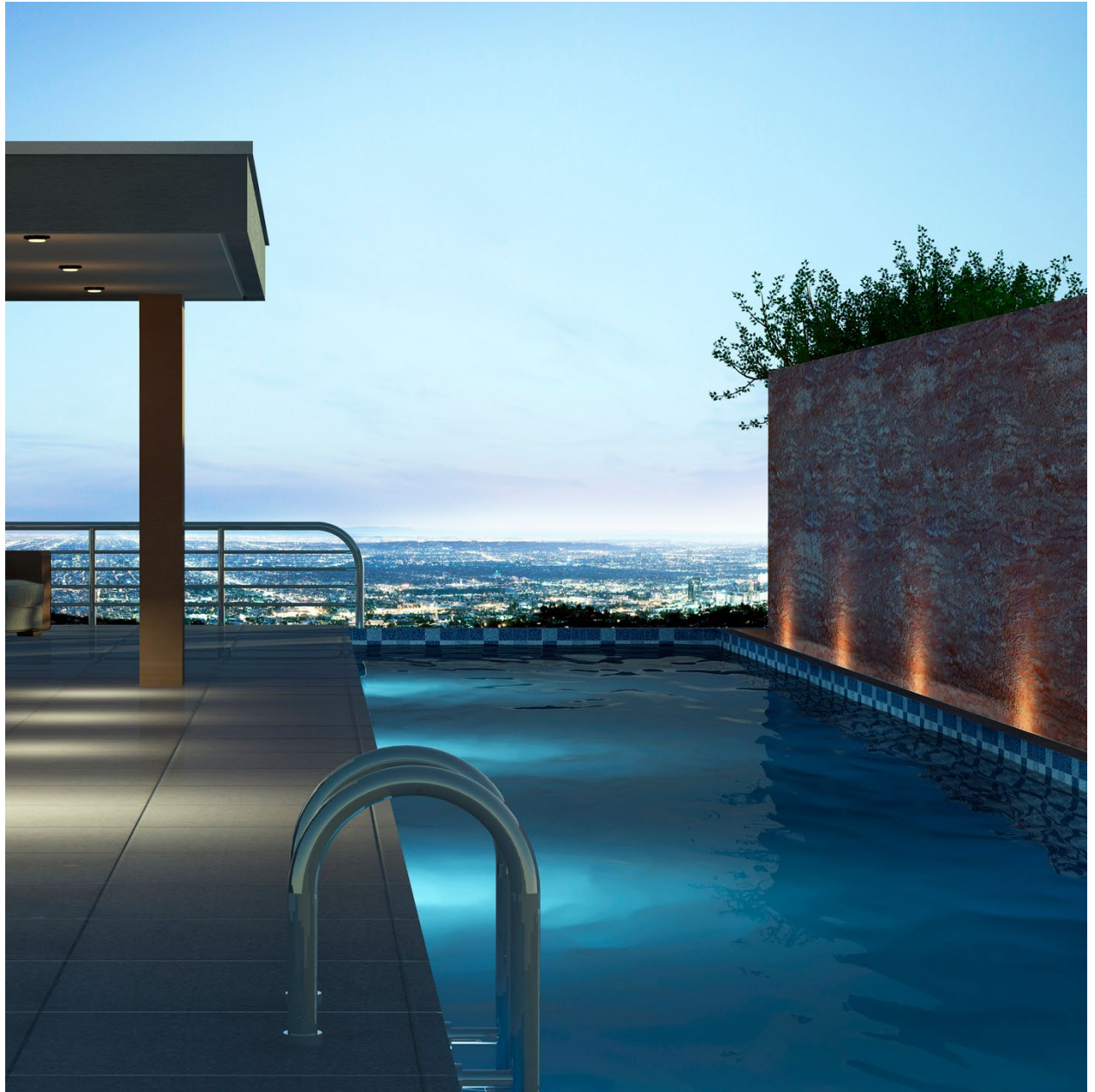

NAVA

IP68 LED

Projector

Ref.	70122	 black negro
Bulb	HIGH POWER LED 15W 6000K 800Lm incl. Driver 46061 350MA DC 40-50V not incl.	
Materials	Die Cast Aluminium + Glass Aluminio Inyectado + Cristal	
V/Hz	100-240V / 50-60 Hz	
EEL	A	
Weight	1.8 kg / 3.97 lb	

+ info

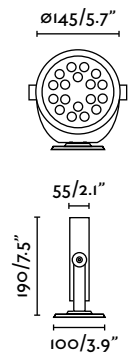

See electrical connections pag. 288
Ver conexiones pág. 288



ONDA

Wall Washer

IP65

LED

Ref.	70120	 black negro
Bulb	HIGH POWER LED 18W 6000K 950Lm incl.	
Materials	Aluminium + Transparent Glass Aluminio + Cristal Transparente	
V/Hz	220-240V / 50-60 Hz	
EEL	A++ to E	
Weight	4.63 kg / 10.21 lb	

+ info      

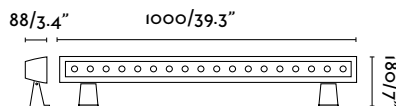

See electrical connections pag. 288
Ver conexiones pág. 288



APOLO

Projector

IP65

Ref.	70021	 black negro
Bulb	2xG24 q-3 32W incl.	
Materials	PVC + Metal + Transparent Glass PVC + Metal + Cristal Transparente	
V/Hz	220-240V / 50 Hz	
EEL	A to B	
Weight	3.2 kg / 7.05 lb	

+ info     

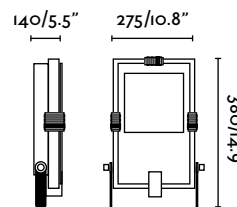

Toni

Design: Alegre Design



Projector and spike for outdoor lighting that provides innovation both in appearance and manufacturing.



[new]

Wall Lamp + Spike

IP65

LED

Ref.

71528



black negro

Bulb

1xGU10 LED 8W not incl. [LED 17325]

Materials

PMMA + Polycarbonate
PMMA + Polycarbonato

V/Hz

100-240V / 50-60 Hz

EEI

A++ to A

Weight

0.30 kg / 0.66 lb

+ info

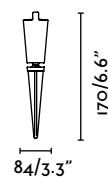

See electrical connections pag. 288
Ver conexiones pag. 288

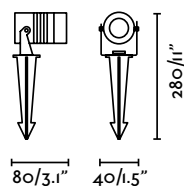

BALDER

Projector / Spike

IP67 LED

Ref.	70469	 black negro
Bulb	SMD LED 3W 3000K 110Lm CRI>80 incl.	
Materials	Aluminium + Transparent Glass Aluminio + Cristal Transparente	
V/Hz	100-240V / 50-60 Hz	
EEl	A	
Weight	0.45 kg / 0.99 lb	

+ info       

See electrical connections pag. 288
Ver conexiones pág. 288

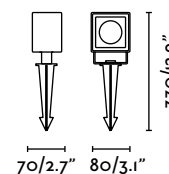

SOBEK

Projector / Spike

IP65 LED

Ref.	70151	 black negro
Bulb	COB LED 7W 3000K 550Lm CRI>80 incl.	
Materials	Die Cast Aluminium + Transparent Glass Aluminio Inyectado + Cristal Transparente	
V/Hz	100-240V / 50-60 Hz	
EEl	A+	
Weight	0.67 kg / 1.48 lb	

+ info       



See electrical connections pag. 288
Ver conexiones pág. 288

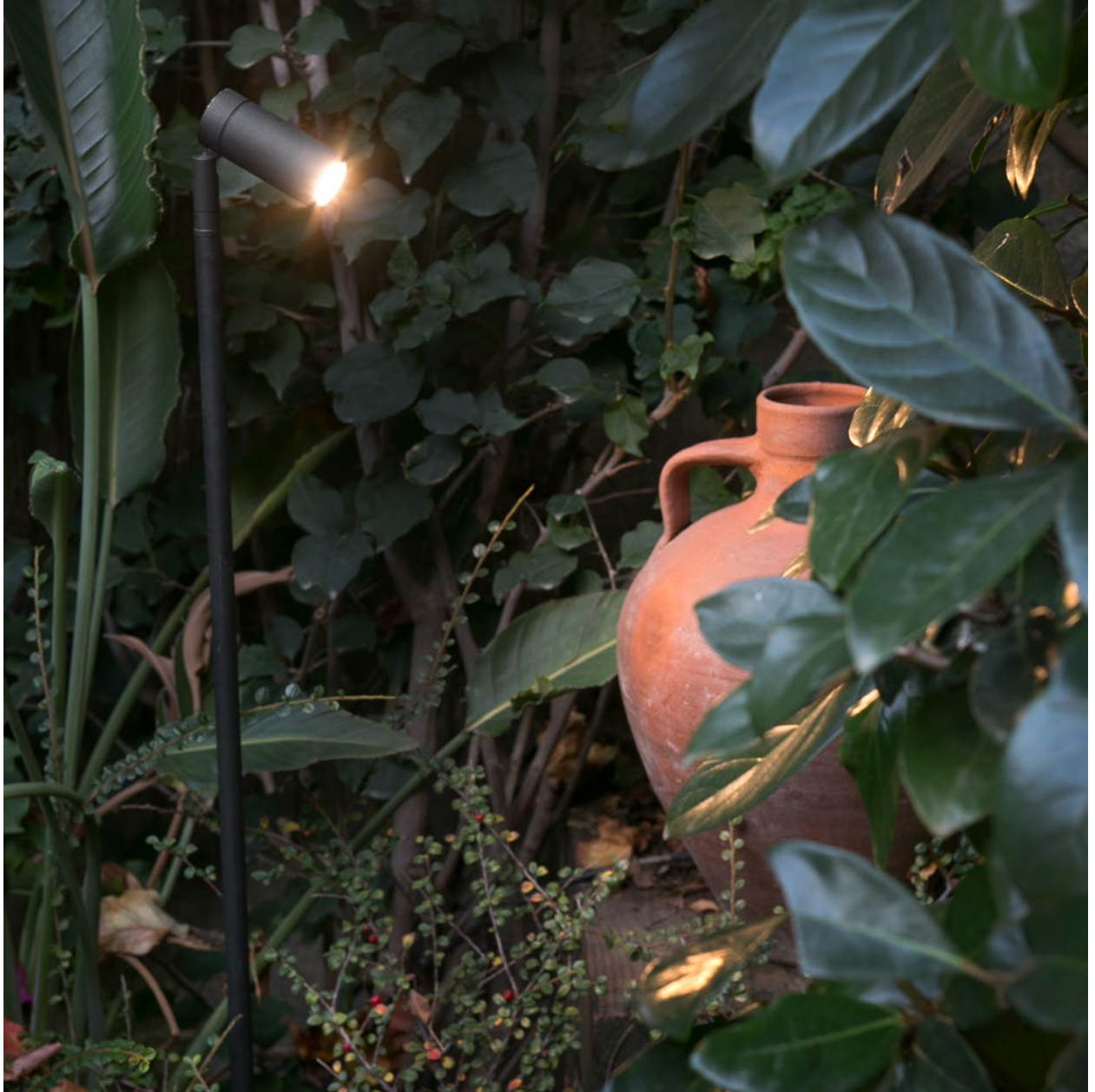

SETH-28 [new]

LED

Spike	
Ref.	70227  black negro
Bulb	SMD LED 6W 2700K 450Lm CRI>80 incl.
Materials	Aluminium + PMMA Aluminio + PMMA
V/Hz	220-240V / 50-60 Hz
EEL	A+
Weight	Falta

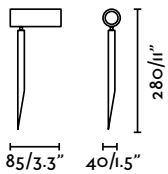

+ info     



SETH-60

LED

Spike	
Ref.	70226  black negro
Bulb	SMD LED 6W 2700K 450Lm CRI>80 incl.
Materials	Aluminium + PMMA Aluminio + PMMA
V/Hz	220-240V / 50-60 Hz
EEL	A+
Weight	0.73 kg / 1.61 lb

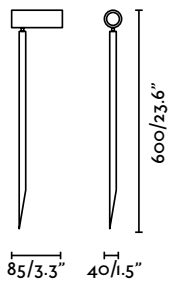

+ info     



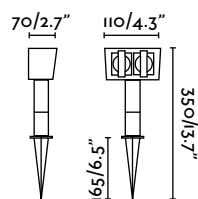

GARTEN -1

Spike

Ref. 73100  black negro

Materials Heat-Resistant ABS
ABS Termoresistente

V/Hz 100-240V / 50-60 Hz

Weight 0.67 kg / 1.48 lb

+ info     



GARTEN -4

Spike

Ref. 73111  black negro

Bulb 1xE27 PAR 38 20W not incl. [LED 17400]

Materials Heat-Resistant ABS
ABS Termoresistente

V/Hz 100-240V / 50-60 Hz

EEL B

Weight 0.55 kg / 1.21 lb

+ info     

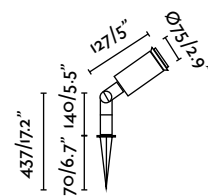

GARTEN -5

Spike

Ref. 73112  black negro

Bulb 2xE27 PAR 38 max 80W not incl. [LED 17400]

Materials Heat-Resistant ABS
ABS Termoresistente

V/Hz 100-240V / 50-60 Hz

EEL B

Weight 0.8 kg / 1.76 lb

+ info    

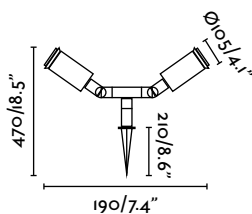



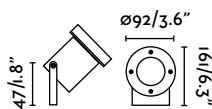

POLA

Projector

IP65

Ref.	73131  black negro
Bulb	1xMR16 Ecohalogen 50W not incl. [LED 14142]
Materials	Die Cast Aluminium + Transparent Glass Aluminio Inyectado + Cristal Transparente
V/Hz	12V / 50 Hz
EEL	B to E
Weight	0.34 kg / 0.75 lb



+ info   

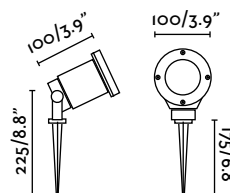

TONO

Projector / Spike

Ref.	73150  black negro
Bulb	1xGUI0 50W not incl. [LED 17325]
Materials	Die Cast Aluminium + Transparent Glass Aluminio Inyectado + Cristal Transparente
V/Hz	220-240V / 50-60 Hz
EEL	A
Weight	0.8 kg / 1.76 lb

+ info    

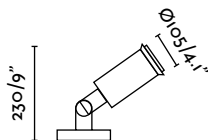

GARTEN -2

Projector

Ref.	73101  black negro
Bulb	1xE27 PAR 38 max 80W not incl. [LED 17400]
Materials	Heat-Resistant ABS ABS Termoresistente
V/Hz	100-240V / 50-60 Hz
EEL	B
Weight	0.26 kg / 0.57 lb





+ info    





IP65

LED

Ref.	19028		warm white blanco cálido	3000K	1350Lm
	19029		cold white blanco frío	5000K	1550Lm
Bulb	LED 36W 24VDC incl.				
EEl	A++ to B				
Weight	0.35 kg / 0.77 lb				

Ref.	19030		rgb rgb
Bulb	LED RGB 36W 24VDC RGB incl.		
EEl	A++ to B		
Weight	0.35 kg / 0.77 lb		

+ info   

30LED/MT 30LED/MT

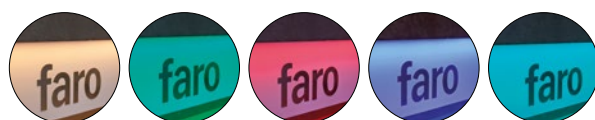

All LED accessories are easy to connect.
Los accesorios para las tiras LED de interior y exterior se unen fácilmente gracias a sus interconectores.



 **Accessories and driver not included.**
Equipo y accesorios no incluidos.



Power Supply
Fuente de alimentación

19031

100-240 V AC 36W 3A 24V DC

220-240V / 50-60 Hz

A++ to B

0.38 kg / 0.84 lb



Remote Control
Mando a distancia

19032



rgb
rgb

220-240V / 50-60 Hz

A++ to B

0.07 kg / 0.15 lb



Conector with cable
Conector con cable

19036 monocolor

19037  rgb
rgb



Conector with jack
Conector con jack

19034 monocolor

19035  rgb
rgb



Al utilizar los accesorios, las tiras de led pierden el ip
With the accessories, led strips lose the ip.
Les bandes de led perdent leur ip avec les accessoires.

Conector
Conector

19038 monocolor

19039  rgb
rgb

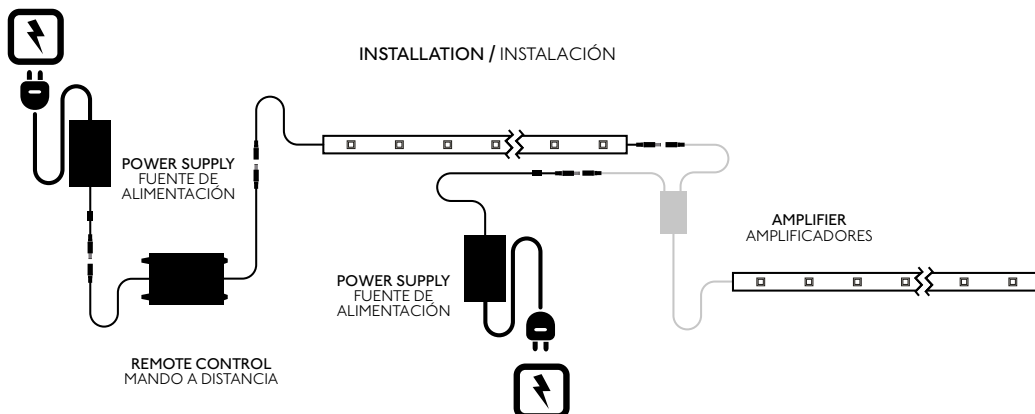

accessories



Connection box [new]
Caja conexión

75800

IP68



Connection box "T" [new]
Caja conexión "T"

75801

IP68



Transformer
Transformador

43070

60W

220-240V / 50-60 Hz

A++ to B

0.14 kg / 0.31 lb



Magnetic Gear ELT 50W
Equipo magnético ELT 50W

98101050

220-240V / 50-60 Hz

A++ to B

0.38 kg / 0.84 lb



Transformer
Transformador

46067

24V / 20W

220-240V / 50-60 Hz

A++ to B

0.07 kg / 0.15 lb



Driver
Driver

46061

Max 3W 350mA

220-240V / 50-60 Hz

A++ to B

0.07 kg / 0.15 lb



Driver
Driver

46060

Max 6W 350mA

100-240V / 50-60 Hz

A++ to B

0.07 kg / 0.15 lb



Power Supply
Fuente de alimentación

I9031

100-240 V AC 36W 3A 24V DC
220-240V / 50-60 Hz
A++ to B
0.38 kg / 0.84 lb



Receptor
Receptor

70475

IR RGB
220-240V / 50-60 Hz
A++ to B
0.38 kg / 0.84 lb

LED RGB Controller
Controlador LED RGB

70472

Remote Control IR RGB
Control Remoto Emisor IR RGB

70474



Recessed box for LISO and ESCA
Caja de empotrar para LISO y ESCA

71482  dark grey
gris oscuro

PVC
PVC

0.38 kg / 0.84 lb



Remote Control
Mando a distancia

I9032  rgb
rgb

220-240V / 50-60 Hz
A++ to B
0.07 kg / 0.15 lb



Slave LED RGB Controller
Controlador Slave LED RGB

70476

24V / 72W
220-240V / 50-60 Hz
A++ to B
0.38 kg / 0.84 lb

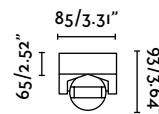

Sensor
Sensor

73115  white
blanco

73116  black
negro

Max 800W

PVC
PVC

220-240V / 50-60 Hz
A++ to B
0.38 kg / 0.84 lb

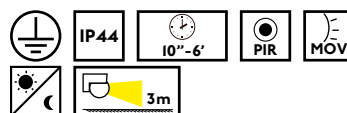

Detection angle: Maximum 120°
Ángulo de detección: Máximo 120°

infor
mation

Faro commitment

ENG	ES	FR	PT
<p>Faro Barcelona Technical Laboratory Faro Barcelona has extended the capacity of its Quality Control Department by equipping its laboratory with machinery that can conduct the following tests:</p> <ul style="list-style-type: none"> - IP Tests - Incandescent thread. - Electric shocks. - Thermal and mechanical resistance. - Impacts. - Consumption and power factors. <p>Thanks to these advances, Faro Barcelona has raised the bar regarding the thoroughness of its tests and ensures that European regulations and standards are complied with fully.</p> <p>Faro collaborates on improvements to the environment With its commitment to efficient light bulbs and its contribution to energy saving and the campaign against global warming. In Faro catalogues, next to the standard-use light bulb given for each item, you will see the recommended low-energy light bulb, highlighted by this symbol: [ref.] [LED ref.]</p>	<p>Laboratorio técnico propio de Faro Barcelona Faro Barcelona ha ampliado la capacidad de su Departamento de Control de Calidad, dotando su laboratorio de una maquinaria capaz de hacer los siguientes ensayos:</p> <ul style="list-style-type: none"> - Pruebas de IP - Hilo incandescente. - Choques eléctricos. - Resistencia térmica y mecánica. - Choques de impacto. - Consumos y factores de potencia. <p>Gracias a estos avances, Faro Barcelona eleva el nivel de rigurosidad en sus ensayos y garantiza el estricto cumplimiento de las normativas y estándares europeos.</p> <p>Faro colabora en la mejora del medio ambiente Apostando por las bombillas eficientes y contribuyendo con el ahorro energético y la lucha contra el calentamiento global. En los catálogos Faro podrá encontrar junto a la bombilla de uso standard de cada artículo cual es la bombilla de bajo consumo que recomendamos y lo diferenciamos con este símbolo: [ref.] [LED ref.]</p>	<p>Laboratoire technique appartenant à Faro Barcelona Faro Barcelona a élargi la capacité de son Département de contrôle qualité, en dotant son laboratoire de machines capables de procéder aux essais suivants:</p> <ul style="list-style-type: none"> - Essais d'IP - Fil incandescent. - Chocs électriques. - Résistance thermique et mécanique. - Chocs d'impact. - Consommations et facteurs de puissance. <p>Grâce à ces avancées, Faro Barcelona élève le niveau de rigueur de ses essais et garantit le strict respect des réglementations et normes européennes.</p> <p>Faro participe à l'amélioration de l'environnement En misant sur des ampoules efficaces, en contribuant aux économies d'énergie et en participant à la lutte contre le réchauffement de la planète. Dans les catalogues Faro, vous trouverez, à côté de l'ampoule standard utilisée pour chaque article, l'ampoule basse consommation recommandée et identifiée par ce symbole: [réf.] [LED réf.]</p>	<p>Laboratório técnico próprio da Faro Barcelona A Faro Barcelona ampliou a capacidade do seu Departamento de Controlo de Qualidade, dotando o seu laboratório de uma maquinaria capaz de fazer os seguintes ensaios:</p> <ul style="list-style-type: none"> - Testes de IP - Fio incandescente. - Choques eléctricos. - Resistência térmica e mecânica. - Choques de impacto. - Consumos e factores de potência. <p>Graças a estes avanços, a Faro Barcelona eleva o nível de rigor nos seus ensaios e garante o estrito cumprimento das normas e padrões europeus.</p> <p>A Faro colabora na melhoria do meio ambiente Apostando nas lâmpadas eficientes e contribuindo para a poupança energética e para a luta contra o aquecimento global. Nos catálogos Faro poderá encontrar, junto à lâmpada de uso padrão de cada artigo, a lâmpada de baixo consumo recomendada e que se diferencia com este símbolo: [ref.] [LED ref.]</p>

GER	NL	BL	PL
<p>Eigenes technisches Labor von Faro Barcelona Faro Barcelona hat die Leistungsfähigkeit seiner Qualitätssicherungsabteilung durch die Ausstattung seines Labors mit Einrichtungen für folgende Tests erweitert.</p> <ul style="list-style-type: none"> - IP-Tests - Thermische und mechanische Elektroschocks Widerstandskraft - Mechanische Stöße - Verbrauchs- und Leistungsaspekte - Glühfäden <p>Dank dieser Erweiterungen kann Faro Barcelona jetzt seine Produktprüfungen noch wesentlich rigoröser durchführen und eine strikte Erfüllung der europäischen Normen und Standards garantieren.</p> <p>Faro bemüht sich ständig um den Umweltschutz Daher verwenden wir immer mehr effiziente Leuchtmittel und tragen damit zum Einsparen von Energie und zum Kampf gegen die Klimaerwärmung bei. In den Katalogen von Faro finden Sie neben den Standard-Leuchtmitteln für die einzelnen Artikel auch jeweils passende Sparbirnen, die mit folgendem Symbol gekennzeichnet sind: [ref.] [LED ref.]</p>	<p>Eigen technisch laboratorium van Faro Barcelona Faro Barcelona heeft de capaciteit van haar Afdeling Kwaliteitscontrole uitgebreid met een laboratorium waarin de volgende testen kunnen worden uitgevoerd:</p> <ul style="list-style-type: none"> - Testen van de IP-code - Gloeidraad. - Elektrische schokken. - Thermische en mechanische weerstand. - Schok door impact. - Verbruik en vermogensfactoren. <p>Dankzij deze vooruitgang is er bij Faro Barcelona sprake van een hoger striktheidniveau tijdens het testen en garandeert een strikte naleving van de Europese normen en standaards.</p> <p>Faro werkt mee aan de verbetering van het milieu Middels het gebruik van efficiënte lampen. Zo draagt zij bij aan de energiebesparing en aan de strijd tegen de opwarming van de aarde. In de catalogi van Faro treft u naast de lamp voor standaardgebruik van ieder artikel de aanbevolen lamp met laag verbruik aan die met dit symbool wordt onderscheiden: [ref.] [LED ref.]</p>	<p>Собствена техническа лаборатория на Faro Barcelona Faro Barcelona разшири капацитета на своя Отдел за контрол на качеството, като обзаведе лабораториите си с оборудване за осъществяване на следните изпитвания:</p> <ul style="list-style-type: none"> - Изпитвания за степен на защита (IP) - Термична и механична - Токови удари. Сустойчивост. - Удари в твърд предмет. - Консумирана мощност - Нажежена жичка. и коефициент на мощността. <p>По този начин Faro Barcelona повишава точността на изпитванията и гарантира стриктно спазване на европейските.</p> <p>Faro съдейства за подобряване на околната среда чрез използване на енергоспестяващи крушки, с което дава своя принос в борбата с глобалното затопляне. В каталозите на Faro всеки продукт може да се използва както със стандартна, така и с енергоспестяваща крушка, която е препоръчителна и е означена със следния символ: [спра.] [LED спра.]</p>	<p>Laboratorium techniczne należące do Faro Barcelona Firma Faro Barcelona rozszerzyła zakres kompetencji swojego Działu Kontroli Jakości, wyposażając laboratorium w urządzenia wykonujące następujące testy:</p> <ul style="list-style-type: none"> - Próby IP - Włókno żarzenia. - Porażenia prądem. - Wytrzymałość termiczna i mechaniczna. - Wstrząsy. - Zużycie i czynniki mocy. <p>Dzięki tym procedurom firma Faro Barcelona zaostrzyła poziom testów, gwarantując bezwzględne przestrzeganie norm i standardów europejskich.</p> <p>Firma Faro chroni środowisko Stawiając na wydajne żarówki i oszczędność energii, przyczyniając się tym samym do walki z globalnym ociepleniem. Oprócz informacji o standardowych żarówkach, katalogi Faro zawierają zalecenia dotyczące żarówek energooszczędnych wyróżnione tym symbolem: [odni.] [LED odni.]</p>

ITA	GRK	RUS	CN
<p>Laboratorio tecnico proprio di faro Barcelona</p> <p>Faro Barcellona ha ampliato la capacità del suo Dipartimento di Controllo della Qualità, dotando il suo laboratorio di macchinari in grado di realizzare i seguenti test:</p> <ul style="list-style-type: none"> - Prove di IP - Filo incandescente. - Scariche elettriche. - Resistenza termica e meccanica. - Test di impatto. - Consumi e fattori di potenza. <p>Grazie a questi progressi, Faro Barcelona alza il livello di rigorosità nei suoi test e garantisce il rigido rispetto delle normative e degli standard europei.</p> <p>Faro collabora al miglioramento dell'ambiente</p> <p>Scommettendo sulle lampadine efficienti e contribuendo al risparmio energetico e alla lotta contro il riscaldamento globale.</p> <p>Nei cataloghi Faro potrete trovare, assieme alla lampadina d'uso standard di ogni articolo, la lampadina di basso consumo consigliata e che si distingue con questo simbolo: [rif.] [LED rif.]</p>	<p>Faro Barcelona Technical Laboratory</p> <p>Η Faro Barcelona έχει διευρύνει τις δυνατότητες του Τμήματος Ελέγχου Ποιότητας, εξοπλίζοντας το εργαστήριό της με μηχανήματα που πραγματοποιούν τα εξής τεστ:</p> <ul style="list-style-type: none"> - Τεστ IP - Νήμα πυρακτώσεως. - Ηλεκτροπληξία. - Θερμική και μηχανική αντοχή. - Κρούση. - Κατανάλωση και παράγοντες ισχύος. <p>Χάρη σε αυτές τις εξελίξεις, η Faro Barcelona αυξάνει το επίπεδο αυστηρότητας στις δοκιμές της και εξασφαλίζει την απόλυτη τήρηση των ευρωπαϊκών κανονισμών και προτύπων.</p> <p>Η Faro συμβάλλει στη βελτίωση του περιβάλλοντος χρησιμοποιώντας αποδοτικούς λαμπτήρες και συμβάλλοντας στην εξοικονόμηση ενέργειας και την καταπολέμηση της υπερθέρμανσης του πλανήτη.</p> <p>Στους καταλόγους της Faro μπορείτε να βρείτε, μαζί με τον συμβατικό λαμπτήρα για κάθε προϊόν, τον συνιστώμενο λαμπτήρα χαμηλής κατανάλωσης που διακρίνεται με αυτό το σύμβολο: [αναφ.] [LED αναφ.]</p>	<p>Собственная техническая лаборатория компании faro Barcelona</p> <p>Потенциал Отдела контроля качества компании Faro Barcelona увеличился благодаря появлению в лаборатории оборудования, с помощью которого можно проводить следующие испытания:</p> <ul style="list-style-type: none"> - Тестирование IP - Механическое и - Поражение электрическим током. - Воздействие от столкновения. - Потребление и - Спираль накаливания. <p>Благодаря этому компания Faro Barcelona предъявляет все более жесткие требования к проведению исследований и обеспечивает строгое соответствие европейским стандартам и нормам.</p> <p>Faro заботится об окружающей среде делая ставку на эффективные электрические лампы, позволяющие экономить энергию и бороться с глобальным потеплением.</p> <p>В каталогах Faro можно найти как стандартные лампы различных типоразмеров, так и рекомендуемые энергосберегающие лампы, отмеченные специальным символом: [ссы.] [LED ссы.]</p>	<p>Собственная техническая лаборатория компании faro Barcelona</p> <p>Потенциал Отдела контроля качества компании Faro Barcelona увеличился благодаря появлению в лаборатории оборудования, с помощью которого можно проводить следующие испытания:</p> <ul style="list-style-type: none"> - Тестирование IP - Механическое и - Поражение электрическим током. - Воздействие от столкновения. - Потребление и - Спираль накаливания. <p>Благодаря этому компания Faro Barcelona предъявляет все более жесткие требования к проведению исследований и обеспечивает строгое соответствие европейским стандартам и нормам.</p> <p>Používáním efektivních žárovek přispívá firma Faro ke zlepšení životního prostředí, úspoře elektrické energie a boji proti globálnímu oteplování.</p> <p>V katalozích Faro naleznete vedle standardní žárovky vhodné pro jednotlivé zboží i doporučenou žárovku s nízkou spotřebou, která je označena tímto symbolem: [ref.] [LED ref.]</p>

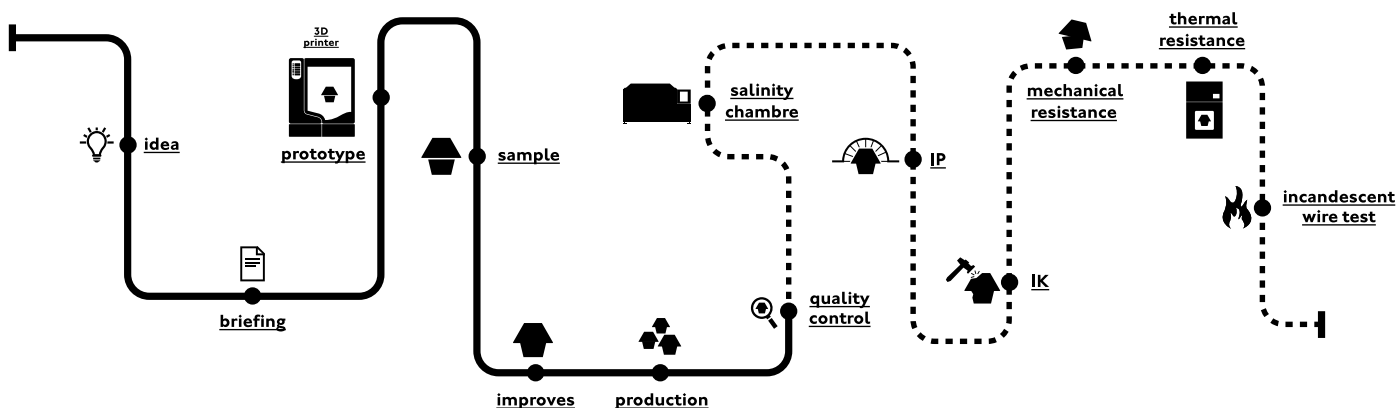

Symbols

	ENG	ES	FR	PT	GER	NL
	Has a protective earth Class I protection	Con toma de tierra Aísla. clase I	Avec prise de terre Catégorie de protection I	Com ligação terra Isolamento classe I	Mit Erdung Isolierung der Klasse I	Met aardleiding Isolatie Klasse I
	Reinforced or double insulation (class II protection)	Aislamiento clase II	Isolement de protection (classe de protection II)	Isolamento (clase II)	Isolierung der Klasse II	Isolatie Klasse II
	Low voltage protection (class III protection)	Aislamiento clase III	Très basse tension de protection (classe protec. III)	Isolamento (clase III)	Isolierung der Klasse III (für montage auf)	Isolatie Klasse III
	No incandescent bulb	No bombilla incandescente	Pas utiliser ampoule incandescence	Não use lâmpada incandescente	Nicht verwenden Glühlampe	Gebruik geen gloeilamp
	Not included Included	No incluida Incluida	Non incluse Incluse	Não incluída Incluída	Nicht eingeschlossen Eingeschlossen	Niet inbegrepen Inbegrepen
	Without shade Sockets	Sin pantalla Tomas	Sans abat-jour Prises	Sem abat jour Tomadas	Ohne Schirm Anschlüsse	Zonder scherm Aansluitingen
	Cable	Cable	Câble	Cabo	Kabel	Kabel
	Cut out	Agujero para empotrar	Trou d'encastrement	Furo para encastrar	Bohrloch zum Einbauen	Gat om in te bouwen
	Service time Charging time	Autonomía Tiempo de carga	Autonomie Temps de charge	Autonomia Tiempo de carga	Brenndauer Aufladezeit	Autonomie Herlaadtijd
	Adjustable duration time	Tiempo de ajuste	Temps de réglage	Tempo de ajuste	Einstellzeit	Afsteltijd
	Resistance in kg	Resistencia en kg	Résistance en kg	Resistência em kg	Widerstand in kg	Weerstand in kg
	Detection angle Sensor movement	Ángulo de detección -Sensor de movimiento	Angle de détection Décteur de mouvement	Angulo de detacção -Sensor de movimento	Detektionswinkel Bewegungssensor	Beschermingshoek Bewegingssensor
	With equipment, ballast included Special transformer	Con equipo, reactancia incluida Transformador especial	Avec l'équipement, ballast inclus Transformateur spécial	Com equipamento, equipamento incluido Transformador especia	Ausrüstung, reaktanz inbegriffen Spezieller Transformator	Met uitrusting, reactancia inbegrepen Speciale transformator
	DRIVER	DRIVER	DRIVER	DRIVER	DRIVER	DRIVER
	Shock resistance	Resistencia a golpes	Résistance aux chocs	Resistência a choque	Schockfestigkeit	Schokbestendigheid
	Recessed box	caja empotrar	Boîte encastrée	Recesso box	Einbaugehäuse	Recessed box
	Maintenance steel	Mantenimiento acero	Acier maintenance	Aço manutenção	Wartung Stahl	Onderhoud Staal
	Dimable	Dimmable	Réglable	Regulável	Dimmbar	Dimbaar
	Detector	Sensor	Détecteur	Sensor	Sensor	Sensor
	Day/night	Día/noche	Jour/nuit	Dia/noite	Nacht	Dag/nacht
	Adjustable	Orientable	Orientable	Ajustável	Verstellbar	Verstelbare
	Remote control	Mando a distancia	Télécommande	Comando à distancia	Vernbedienung	Dubbele intensiteit
	Photometric	Fotométrica	Photométrique	Fotométrico	Photometrische	Fotometrische
	Light up	Luz arriba	Lumière de haut	Luz para cima	Licht auf	Lichte omhoog
	Light down	Luz abajo	Lumière vers les bas	Luz para baixo	Licht nach unten	Licht omlaag
	Light up and down	Luz arriba y abajo	Lumière de haut en bas	Luz para cima e para baixo	Licht auf und ab	Licht boven en beneden
	Beam angle	Grados apertura	Grades halo lumineux	Notas luz	Light grade	Licht rangen
	Blister	Blister	Blister	Blister	Blister	Blister
	Underwater x mts	Sumergibles x mts	Sous-marin x mts	Debaixo d'água x mts	Unterwasser x mts	Onderwater x mts
	Spike	Estaca	Piquet	Spike	Spike	Spike
	Adjustable	Orientable	Orientable	Ajustável	Drehbar	Verstelbare

	ITA	GRK	RUS	CZ	BL	PL
	Con messa a terra Isola. tipo I	Με γείωση Μόνωση κλάσης I	С контактом заземления Изоляция класс I	S uzemněním Izolace třídy I	Със заземяване Изоляция клас I	Z uziemieniem Izolacja klasy I
	Isolamento tipo II	Μόνωση κλάσης II	Изоляция класс II	Izolace třídy II	Изоляция клас II	Izolacja klasy II
	Isolamento tipo III	Μόνωση κλάσης III	Изоляция класс III	Izolace třídy III	Изоляция клас III	Izolacja klasy III
	Non lampadina a incandescenza	Δεν λάμπα πυρακτώσεως	нет накаливания	No žárovka	не крушка с нажежаема жичка	żarówka nie używać
	Non inclusa Inclusa	Δεν συμπεριλαμβάνεται συμπεριλαμβάνεται	Не включена включена	Není přiložena Přiložena	Не е включена Включена	Nie dołączono Dołączono
	Senza paralume Prese	Χωρίς καπέλο Πρίζες	Без экрана Розетки	Bez obrazovky/přívodů	Без екран/контакти	Bez ekranu/gniazdek
	Cavo	Καλώδιο	кабель	kabel	кабел	kabel
	Foro per incasso	Οπή για εντοίχιση	Отверстие для встраивания	Otvor k vložení	Монтажен отвор	Otwór do mocowania
	Autonomia Tiempo de carga	Αυτονομία Χρόνος επαναφόρτισης	Длительность работы Время зарядки	Výdrž - doba nabíjení	Време за автономна работа време за зареждане	Zakres czasu ładowania
	Tempo di regolazione	Χρόνος προσαρμογής	Время регулировки	Čas seřízení	Време за настройка	Czas regulacji
	Resistenza in kig	Ανθεκτικότητα σε κιλά	Сопротивление в килограммах	Odolnost v kg	Устойчивост в килограми	Wytrzymałość w kilo
	Angolo di rilevamento -Sensore movimento	Γωνία ανίχνευσης Αισθητήρας κίνησης	Угол обнаружения Датчик движения	Detekční úhel / senzor pohybu	Ъглов обхват / сензор за движение	Kąt wykrywania/czujnik ruchu
	Con attrezzatura reattanza inclusa Trasformatore speciale	Με εξοπλισμό Συμπεριλαμβάνεται αντίσταση Ειδικός μετασχηματιστής	С оборудованием сопротивление включено Специальный трансформатор	Včetně zařízení reaktance Speciální transformátor	С оборудване включено съпротивление Специален трансформатор	Zestaw reakcji w komplecie Specjalny transformator
	DRIVER	DRIVER	DRIVER	DRIVER	DRIVER	DRIVER
	Resistenza agli urti	Σοκ αντίσταση	Ударопрочность	Odolnost proti rázům	Шоково съпротивление	Odporność na wstrząsy
	Incasso box	χωνευτα κουτι	Монтажная коробка	Recessed box	за вграждане box	Puszka
	Manutenzione in acciaio	Χάλυβα Συντήρηση	Техническое обслуживание сталь	Údržba ocel	Поддръжка стомана	Stali Konserwacja
	Regolabile	ροοστάτη	затемняемый	Stmivatelné	димиране	ściemniania
	Sensor	Αισθητήρας	Датчик	Senzor	Сензор	Czujnik
	Giorno/notte	День/Ночь	Нjмepa – нjчтa	Den/noc	Ден/нощ	Dzień/noc
	Regolabile	ρυθμιζόμενο	Регулируемый	Nastavitelný	Регулируеми	Orientacja
	Doppia intensità	Τηλεχειριστήριο	Дистанционное управление	Dálkové ovládání	Дистанционно управление	Zdalne sterowanie
	Fotometrica	φωτομετρικός	фотометрический	Fotometrické	Фотометрично	Fotometryczny
	Luce su	φως εγγραφη	Свет вверх	Osvětit	лайт нагоре	Zapalać się
	Luce giù	φως κάτω	Свет вниз	Světlo dolů	лайт надолу	Światło w dół
	Luce su e giù	φως εγγραφη και κάτω	Свет вверх и вниз	Světlo nahoru a dolů	лайт нагоре и надолу	Światło w górę i w dół
	Gradi di luce	φως βαθμών	Светлые сорта	Světlo třídy	Светлинни марки	Lekkie klasy
	Blister	Blister	Blister	Blistr	блистер	Blister
	Subacquea x mts	Υποβρυχια x mts	подводный x мтс	Pod vodou x mts	подводни x mts	x mts podwodne
	Picco	Spike	Спайк	Spike	Спайк	Spike
	Regolabile	ρυθμιζόμενο	Регулируемый	Nastavitelný	Регулируеми	Orientacja

Materials

	ES	FR	PT	GER	NL	ITA
Abs	ABS	ABS	ABS	ABS	ABS	ABS
Aluminium	Aluminio	Aluminium	Alumínio	Aluminium	Aluminium	Alluminio
Beveled glass	Cristal biselado	Verre biseauté	Vidro biselado	Abgeschrägtes Glas	Schuine glas	Vetro smussato
Bubble glass	Cristal burbuja	Verre bullé	Vidro bolha	Blasenglas	Bubble glas	Vetro bolla
Brass	Latón	Laiton	Bronze	Messing	Messing	ottone
Die cast Aluminium	Aluminio inyectado	Fonte d'aluminium	Alumínio fundido	Aluminiumguss	Gegoten aluminium	Ghisa alluminio
Glass	Cristal	Verre	Virdo	Glas	Glas	Vetro
Heat-resistant abs	ABS resistente al calor	ABS Résistant à la chaleur	ABS Resistente ao calor	Hitzebeständige ABS	Hittebestendig ABS	ABS Resistente al calore
Metal	Metal	Métal	Metal	Metall	Metaal	Metallo
Opal acrylic	Acrílico opal	Acrylique opale	Opal acrílico	Opalacryl	Opaal acrylaat	Acrilico opale
Opal glass	Cristal opal	Verre opale	Vidro opal	Opalglas	Opaal glas	Vetro opalino
Opal pmma	PMMA opale	PMMA opale	PMMA opal	Opal PMMA	Opaal PMMA	PMMA opale
Opal Polycarbonate	Polycarbonato opal	Polycarbonate opale	Policar-bonato opal	Opal polycarbonat	Opaal polycarbonnat	Policar-bonato opale
Opal Polyethylene	Polietileno opal	Polyéthylène opale	Polietileno opal	Polyethylen opal	Polyethyleen opaal	Polietilene opale
Opal pvc	Opal PVC	PVC opale	PVC opal	Opal PVC	Opaal PVC	PVC opale
Optical glass	Cristal óptico	Verre optique	Vidro óptico	Optisches Glas	Optisch glas	Vetro ottico
Pemd	PEMD	PEMD	PEMD	PEMD	PEMD	PEMD
Pmma	PMMA	PMMA	PMMA	PMMA	PMMA	PMMA
Polycarbonate	Polycarbonato	Polycarbonate	Polycarbonato	Polycarbonat	Polycarbonaat	Polycarbonato
Pvc	PVC	PVC	PVC	PVC	PVC	PVC
Rustic glass	Cristal rústico	Verre rustique	Vidro rústico	Rustikale Glass	Rustieke Glass	Vetro rustico
Stainless steel	Acero inoxidable	Acier inoxydable	Aço inoxidável	Edelstahl Rostfreier	Roestvrij staal	Acciaio inossi.
Steel	Acero	Acier	Aço	Stahl	Staal	Acciaio
Tempered glass	Cristal templado	Verre trempé	Vidro temperado	Gehärtetes Glas	Gehard glas	Vetro temperato
Tempered transparent glass	Cristal transparente templado	Verre trempé transparent	Vidro transparente temperado	Gehärtetes Glas transparent	Gehard transparant glas	Vetro temperato trasparente
Translucent glass	Cristal translúcido	Verre translucide	Vidro translúcido	Translucent Glas	Doorschijnend glas	Vetro traslucido
Translucent Polycarbonate	Polycarbonato translúcido	Polycarbonate translucide	Policar-bonato transl.	Translucent polycarbonat	Doorschijnend polycarbo.	Policar-bonato transl.
Translucent pvc	PVC translúcido	PVC translucide	PVC translúcido	Translucent PVC	Doorschijnend PVC	PVC traslucido
Transparent glass	Cristal transparente	Verre transparent	Vidro transpa.	Transparentem Glas	Transparant glas	Vetro trasparente
Transparent polycarbonate	Polycarbonato transparente	Polycarbonate transparent	Polycarbonato transparente	Transparent polycarbonate	Transparant polycarbonaat	Polycarbonato trasparente
Transparent pvc	PVC transparente	PVC transparent	PVC transp.	Transparentes PVC	Transparant PVC	PVC transp.

	GRK	RUS	CZ	BL	PL
Abs	ABS	ABS	ABS	ABS	ABS
Aluminium	Αλουμίνιο	Алюминий	Hliník	Алуминий	Aluminium
Beveled Glass	λοξόμητη γυαλί	Скошенные стекла	Zkosené sklo	Beveled στýκλο	Fazowane szklo
Bubble Glass	Γυαλί φούσκα	Рузырь стекло	Bublina sklo	балон στýκλο	Szklane bańki
Brass	ορείχαλκος	латунь	mosaz	месинг	mosiądz
Die Cast Aluminium	Χυτό αλουμίνιο	Ритого алюминия	Z litého hliníku	Рят алуμινий	Odlew aluminiowy
Glass	Γυαλί	Стекло	Sklo	Стýκλο	Szklo
Heat-Resistant Abs	Ανθεκτικά στη θερμότητα ABS	Термостойкие ABS	Teplně odolná ABS	Топлоустойчив ABS	ABS odporu na ciepło
Metal	Μέταλλο	Металл	Kov	Μεταλ	Metat
Opal Acrylic	Opal ακρυλικό	Опалового акрила	Opalový akrylát	Opal ακριλ	Opal akryl
Opal Glass	Opal γυαλί	Ματωое стекло	Opalové sklo	Μλечно στýκλο	Szklo mleczne
Opal Pmma	Opal PMMA	PMMA ακριλoυvιε	Opal PMMA	Opal PMMA	Mlecznego PMMA
Opal Polycarbonate	Opal πολυάνθρακας	Opal πολυκαρβονατ	Opal polykarbonát	Opal πολυκαρβονατ	Mlecznego Poliwęglan
Opal Polyethylene	πολυαιθυλένιο opal	πολυεθιλεν opal	Polyethylen opál	Πολυεθιλενοvi Opal	Polietylen opal
Opal Pvc	Opal PVC	Opal PVC	Opal PVC	Opal PVC	PVC Poliwęglan
Optical Glass	Οπτική γυαλί	Οπτισηοο στεκλο	Optické sklo	Οπτισηο στýκλο	Szklat optycznego
Pemd	PEMD	PEMD	PEMD	PEMD	PEMD
Pmma	PMMA	PMMA	PMMA	PMMA	PMMA
Polycarbonate	Πολυκαρβονικά	Πολυκαρβονατ	Polykarbonát	Πολυκαρβονατ	Poliwęglan
Pvc	PVC	PVC	PVC	PVC	PVC
Rustic Glass	ρουστίκ Γυαλί	Сельский στεκλα	Rustikální sklo	Ρουστίκ στýκλο	Rustic Szklo
Stainless Steel	Ανοξείδωτο χάλυβα	нержавеющая сталь	Nerez	нерждаема στομανα	Stali nierdzewnej
Steel	χάλυβα	σταλ	Ocel	Сτομανα	Stal
Tempered Glass	γυαλί	ζακαλενηο στεκλο	Tvrzené sklo	Ζακαλενο στýκλο	Szklo hartowane
Tempered Transparent Glass	Μετριάζεται διαφανές γυαλί	Ζακαλενηο προζακαλενηο στεκλο	Tvrzené sklo čiré	Ζακαλενο προζακαλενηο στýκλο	Szklo hartowane przejrzyste
Translucent Glass	Διαφανές γυαλί	Προζακαλενηο στεκλα	Translucent στýκλο	Průhledné sklo	Przezroczyste szklo
Translucent Polycarbonate	Διαφανές πολυάνθρακας	Προζακαλενηο πολυκαρβονατ	Translucent polykarbonát	Průhledné πολυκαρβονατ	Przezroczyste Poliwęglan
Translucent Pvc	Διαφανές PVC	Προζακαλενηο PVC	Translucent PVC	Průhledné PVC	Przezroczyste PVC
Transparent Glass	Διαφανές γυαλί	Προζακαλενηο στεκλο	Průhledné sklo	Προζακαλενηο στýκλο	Przezroczystego szkla
Transparent Polycarbonate	διαφανές πολυανθρακικό	προζακαλενηο πολυκαρβονατ	Transparentní polycarbonate	προζακαλενηο πολυκαρβονατ	Przezroczysty poliwęglan
Transparent Pvc	Διαφανές PVC	Προζακαλενηο PVC	Průhledné PVC	Προζακαλενηο PVC	PVC Poliwęglan

Finishes

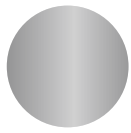

Aluminium

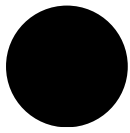

Black



Blue



Bordeaux

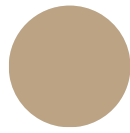

Brass

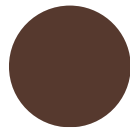

Brown

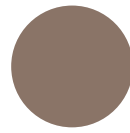

Brown

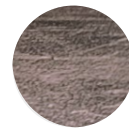

Brushed
brown

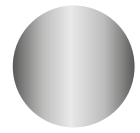

Chrome



Dark brown



Dark grey



Fuchsia



Green



Grey

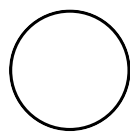

Cold white



Matt nickel

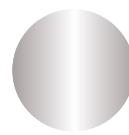

Nickel



Lime green



Off white



Orange



Old gold

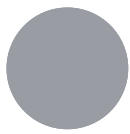

Old silver



Polished
aluminium



Red

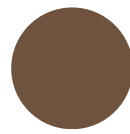

Rust brown



Silver

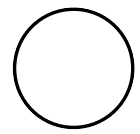

White



Wood

Recessed drainage



Para poder hacer uso de la garantía es imprescindible que la conexión externa sea de un índice de protección (ip) igual o superior a la luminaria adquirida.

In order to validate the warranty the external connection must have always the protection index (ip) with an equal or a superior value of the ip shown on the lamp.

Pour que la garantie soit valable, il est indispensable que la connexion externe soit d'un indice de protection (ip) égal ou supérieur à celui du luminaire acheté.

Per poter usufruire della garanzia è imprescindibile che la connessione esterna sia di un indice di protezione (ip) uguale o superiore a quello indicato sulla lampada acquistata.

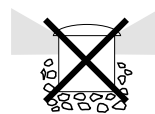

Placing sunken lighting in the ground
Colocación del empotrable en el terreno
Installation de l'encastrable sur le terrain
Installazione dell'incasso nel terreno

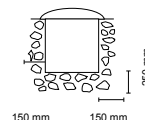
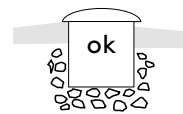

Minimum drainage measures
Medidas mínimas de drenaje
Mesures de drainage minimum
Misure minime di drenaggio

ENG	ES	FR	ITA
-----	----	----	-----

Placing sunken lighting in the ground

All sunken lights are ready for installing in the ground or in cement. Always ensure that they are not placed in watercourses or depressions in the ground.

Position the mounting box surrounded by the fastening material to ensure that it does not tip or fall over. There must be a layer of gravel below and around the mounting box for draining purposes (see drawing). Correct drainage should allow 5 litres of water to be absorbed within 8 minutes. The glass can reach high temperatures, so contact with people and objects should be avoided.

We recommend that the outside of the apparatus be cleaned regularly to stop foreign materials from preventing the dissipation of heat which leads to changes in the components and a loss of watertightness.

Follow the installation and assembly instructions and maintenance recommendations very carefully.

Condensation

To minimise possible condensation inside the device, turn it on for 1 hour without the protective glass, closing it immediately once this time has elapsed.

Colocación del empotrable en el terreno

Todos los empotrables están previstos para una instalación en tierra o en cemento. Evite siempre colocarlo en vaguadas o depresiones del terreno.

Coloque la caja de empotrar rodeada de material de sujeción para evitar que se incline o se hunda. Por debajo y alrededor de la caja de empotrar debe existir una capa de grava para drenaje (ver dibujo). Un drenaje correcto debe permitir la absorción de 5 litros de agua en 8 minutos. El cristal puede alcanzar temperaturas elevadas por lo tanto evite el contacto con personas o cosas.

Es aconsejable limpiar frecuentemente el exterior del aparato para evitar así que materiales extraños impidan la disipación del calor con la consiguiente alteración de los componentes y pérdida de estanqueidad.

Siga detenidamente las instrucciones de instalación y montaje así como las recomendaciones de mantenimiento.

Condensación

Para minimizar la posible condensación de vapor de agua dentro del aparato, debe hacerse funcionar durante 1 hora sin el cristal de protección, transcurrido ese periodo de tiempo, ciérrelo inmediatamente.

Installation de l'encastrable sur le terrain

Tous les luminaires encastrables sont prévus pour une installation dans la terre ou le ciment. Évitez toujours de les installer dans des lignes de creux ou des dépressions du terrain. Installer le boîtier d'encastrement avec ses supports afin d'éviter qu'il ne soit incliné ni trop enfoncé. Sous le boîtier d'encastrement et autour de celui-ci, il doit y avoir une couche de gravier pour le drainage (voir dessin). Un drainage correct doit permettre l'absorption de 5 litres d'eau en 8 minutes.

Le verre peut atteindre des températures élevées, évitez par conséquent tout contact avec les personnes ou des objets. Il est conseillé de nettoyer fréquemment l'extérieur de l'appareil, afin d'éviter que des corps étrangers n'empêchent la dissipation de la chaleur puis l'altération des composants et la perte d'étanchéité.

Suivez attentivement les instructions d'installation et de montage, ainsi que les recommandations de maintenance.

Condensation

Pour minimiser les risques de condensation de la vapeur d'eau intérieur de l'appareil doit être exploité pendant une heure sans le verre de protection, après cette période temps, fermer immédiatement.

Collocazione dell'incasso nel terreno

Tutti gli incassi sono pensati per la collocazione in terra o cemento. Evitare sempre di installarli in zone umide o depressioni del cemento. Installare sempre l'incasso circondato da materiale d'appoggio, per evitare che si inclini o affondi. Sotto ed intorno all'incasso deve sempre esserci sabbia drenante (disegno). Un drenaggio efficace deve permettere l'assorbimento di 5 litri d'acqua in 8 minuti. Il vetro può raggiungere temperature elevate, per tanto evitare il contatto con persone o cose.

Si consiglia di pulire frequentemente l'esterno degli apparati per evitare che corpi estranei impidano la dissipazione del calore con conseguente alterazione dei componenti e perdita delle stagnezza.

Seguire attentamente le indicazioni di installazione e montaggio, così come le norme di manutenzione.

Condensazione

Per evitare la possibile condensazione di vapore acqueo all'interno dell'apparato, deve porsi in funzione durante una ora senza il cristallo di protezione e poi procedere alla chiusura immediatamente.

Beacons

To ensure the proper conservations of beacons we recommend their installation on a plinth, never directly onto the ground or lawn.

Para una correcta conservación de las balizas, recomendamos su aplicación sobre una pilastra a un nivel superior, y nunca sobre tierras o césped.

Pour un bon maintenance de balises, nous recommandons son application sur un pilier à un niveau supérieur, et jamais sur terre ou sur l'herbe.

Per una corretta conservazione dei paletti raccomandiamo la sua applicazione su di una base ad un livello più alto, mai su terra o erba.



Stainless steel

ENG	ES	FR	ITA
-----	----	----	-----

Cleaning and maintenance of stainless steel

It is advisable to follow the recommendations listed below for the correct maintenance and upkeep of all products manufactured from stainless steel

In industrial or coastal areas localized corrosion can be caused by the accumulation of contaminants carried by the air. By using a cloth or duster will insure the elimination of these contaminants. In the case dirt which is more difficult to remove, it is recommended the use of a cleaner which includes phosphoric acid, ensuring that a scrubber or soft nylon brush is used, never use a steel scrubber.

It is recommendable to clean stainless steel every 6 to 12 months for average dirt and every 3 months for more severe cases. Especially in the following atmospheric conditions

- Marine atmospheres.
- Atmospheres which contain a lot of industrial contaminants.
- Atmospheric and traffic pollution.

Limpieza y mantenimiento del acero inoxidable

Le aconsejamos que siga las siguientes recomendaciones para la conservación y mantenimiento de todos aquellos artículos fabricados en acero inoxidable.

En zonas industriales o costeras se pueden producir corrosiones localizadas por acumulaciones de contaminantes llevados por el aire, asegúrese que se eliminan dichos contaminantes utilizando un paño húmedo o una gamuza. En caso de suciedad más difícil le recomendamos que utilice un limpiador que incluya ácido fosfórico siempre con el uso de estropajos o cepillos suaves de nylon, nunca usar estropajos de acero.

La frecuencia de limpieza que le recomendamos para una suciedad moderada es de 6-12 meses y de 3 meses cuando es más abundante. Especialmente en ambientes que recojan las siguientes condiciones:

- Atmósferas marinas.
- Ambientes cargados de contaminantes industriales.
- Suciedad atmosférica y del tráfico.

Nettoyage et entretien de l'acier inoxydable

Nous vous conseillons de suivre les suggestions pour la conservation et l'entretien de tous les articles fabriqués en acier inoxydable.

Dans les zones industrielles ou proches au littoral, il peut s'y produire des corrosions localisées par l'accumulation de contaminants apportés par l'air, assurez-vous que ces contaminants puissent s'éliminer avec un torchon humide ou une peau de chamois.

En cas de saleté plus difficile, nous vous conseillons d'utiliser un nettoyant à base d'acide phosphorique, toujours à utiliser avec des tampons à récurer ou des brosses douces en nylon, ne jamais utiliser de tampons à récurer en acier.

La fréquence de nettoyage que nous vous conseillons pour une saleté modérée est de 6 à 12 mois et de 3 mois quand celle-ci est plus abondante. Surtout dans les ambiances avec les conditions suivantes:

- Atmosphères marines.
- Ambiances chargées de contaminants industriels.
- Saleté atmosphérique et de circulation.

Pulizia e manutenzione dell'acciaio inossidabile

Consigliamo di seguire le raccomandazioni per la conservazione e manutenzione di tutti quei prodotti fabbricati in acciaio inossidabile.

In zone industriali o costiere si possono produrre corrosioni localizzate a causa dei contaminanti presenti nell'aria; suddette corrosioni si possono eliminare utilizzando un panno umido o di camoscio.

In caso di sporcizia più difficile raccomandiamo l'utilizzo di acido fosforico come prodotto di pulizia e manutenzione (utilizzando spugnette, panni soffici o spazzole di nylon).

La frequenza raccomandata è: 6-12 mesi per una sporcizia moderata, 3 mesi per le più difficili.

- Ambienti critici:
- Atmosfera marina
- Ambienti carichi di contaminanti industriali
- Atmosfere cittadine con elevato indice di traffico.

IP Information

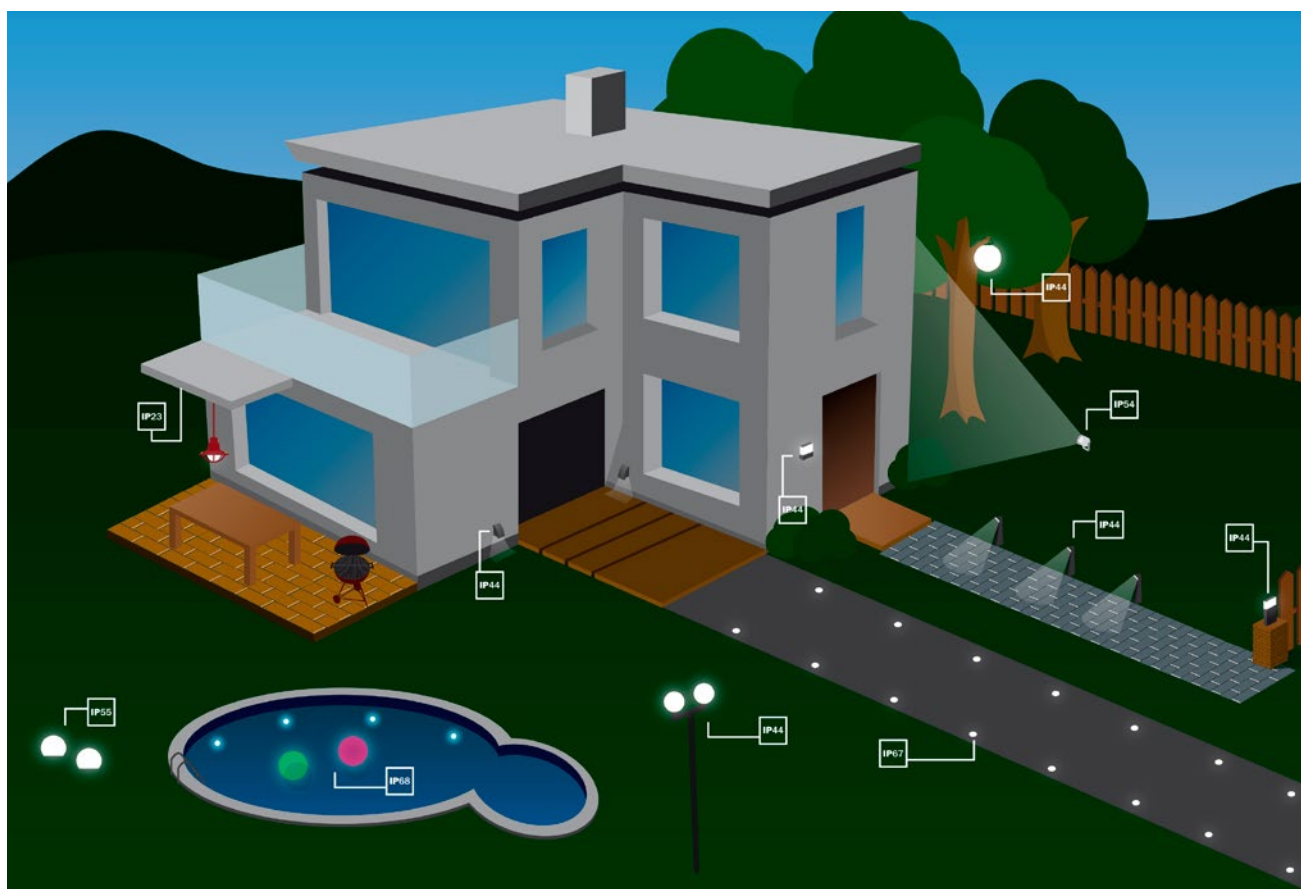

ENG	ES	FR	PT
<p>The first digit (IP x...) indicates the protection from solid objects.</p> <p>0 Non protected.</p> <p>1 Protected against solid objects bigger than 50 mm.</p> <p>2 Protected against solid objects bigger than 12 mm.</p> <p>3 Protected against solid objects bigger than 2,5 mm.</p> <p>4 Protected against solid objects bigger than 1 mm.</p> <p>5 Dust protected.</p> <p>6 Dust tight.</p>	<p>La primera cifra (IP x...) indica la protección del aparato contra penetración de cuerpos sólidos.</p> <p>0 No protegido</p> <p>1 Protegido contra la penetración de cuerpos sólidos con $\varnothing \geq 50$ mm</p> <p>2 Protegido contra la penetración de cuerpos sólidos con $\varnothing \geq 12$ mm</p> <p>3 Protegido contra la penetración de cuerpos sólidos con $\varnothing \geq 2,5$ mm</p> <p>4 Protegido contra la penetración de cuerpos sólidos con $\varnothing \geq 1$ mm</p> <p>5 Protegido contra el polvo</p> <p>6 Totalmente protegido contra el polvo</p>	<p>Le premier chiffre (IP x...) indique le degré de protection des parties contre les corps solides.</p> <p>0 Pas de protection.</p> <p>1 Protection contre corps de diamètre supérieur à 50 mm.</p> <p>2 Protection contre corps de diamètre supérieur à 12 mm.</p> <p>3 Protection contre corps de diamètre supérieur à 2,5 mm.</p> <p>4 Protection contre corps de diamètre supérieur à 1 mm.</p> <p>5 Protection contre dépôts de poussière.</p> <p>6 Protection contre toute infiltration de poussière.</p>	<p>O primeiro dígito (IP x...) indica o grau de protecção contra corpos sólidos.</p> <p>0 Sem protecção.</p> <p>1 Protegido contra a penetração de corpos sólidos com $0 > 50$ mm.</p> <p>2 Protegido contra a penetração de corpos sólidos com $0 > 12$ mm.</p> <p>3 Protegido contra a penetração de corpos sólidos com $0 > 2,5$ mm.</p> <p>4 Protegido contra a penetração de corpos sólidos com $0 > 1$ mm.</p> <p>5 Protegido contra o pó.</p> <p>6 Totalmente protegido contra o pó.</p>
<p>The second digit (IP ...y) indicates protection from moisture.</p> <p>0 Non protected.</p> <p>1 Protected against dripping water.</p> <p>2 Protected against dripping water when tilted up to 15°.</p> <p>3 Protected against spraying water.</p> <p>4 Protected against splashing water.</p> <p>5 Protected against water jets.</p> <p>6 Protected against heavy seas.</p> <p>7 Protected against the effects of immersion.</p> <p>8 Protected against submersion.</p>	<p>La segunda cifra (IP ...y) indica la protección del aparato contra la lluvia.</p> <p>0 No protegido</p> <p>1 Protegido contra la caída vertical de gotas de agua</p> <p>2 Protegido contra la lluvia con un ángulo máx de 15° sobre la vertical</p> <p>3 Protegido contra la lluvia con un ángulo máx de 60° sobre la vertical</p> <p>4 Protegido contra salpicaduras y protección del agua</p> <p>5 Protegido contra chorros de agua</p> <p>6 Protegido contra potentes chorros de agua</p> <p>7 Protegido contra inundaciones temporales.</p> <p>8 Protegido contra inmersiones prolongadas</p>	<p>Le deuxième chiffre (IP ...y) indique le degré de protection contre l'eau.</p> <p>0 Pas de protection.</p> <p>1 Protection contre chute verticale de gouttes d'eau.</p> <p>2 Protection contre chute de gouttes d'eau jusqu'à 15° de la verticale.</p> <p>3 Protection contre pluie de 0° à 60° de la verticale et ruissellement.</p> <p>4 Protection contre projections d'eau de toutes les directions.</p> <p>5 Protection contre jets d'eau de toutes les directions.</p> <p>6 Protection contre jets d'eau de forte pression et paquets de mer.</p> <p>7 Protection contre immersion à moins d'un metre de profondeur.</p> <p>8 Protection contre immersion permanente à plus d'un mètre de profondeur.</p>	<p>O segundo dígito (IP ...y) indica o grau de protecção contra po e chuva.</p> <p>0 Sem protecção.</p> <p>1 Protegido contra a queda vertical de gotas de água.</p> <p>2 Protegido contra água em forma de chuva com um angulo max. de 15°.</p> <p>3 Protegido contra água em forma de chuva com um angulo max. de 60°.</p> <p>4 Protegido contra projecções de água.</p> <p>5 Protegido contra jactos de água em todas as direcções.</p> <p>6 Protegido contra potentes jactos de água.</p> <p>7 Protegido contra a imersão temporária.</p> <p>8 Protegido contra a imersão prolongada.</p>

GER	NL	ITA	GRK
<p>Die erste Ziffer (IP x...) gibt den Schutz des Apparats gegen das Eindringen von festen Körpern an.</p> <p>0 Nicht geschützt.</p> <p>1 Geschützt gegen das Eindringen von festen Körpern mit $\varnothing \geq 50$ mm.</p> <p>2 Geschützt gegen das Eindringen von festen Körpern mit $\varnothing \geq 12$ mm.</p> <p>3 Geschützt gegen das Eindringen von festen Körpern mit $\varnothing \geq 2,5$ mm.</p> <p>4 Geschützt gegen das Eindringen von festen Körpern mit $\varnothing \geq 1$ mm.</p> <p>5 Geschützt gegen Staub.</p> <p>6 Vollkommen gegen Staub geschützt.</p>	<p>Het eerste cijfer (IP x...) geeft de beschermingsgraad weer van het apparaat tegen het binnendringen van vaste elementen.</p> <p>0 Biedt geen bescherming</p> <p>1 Biedt bescherming tegen het binnendringen van vaste elementen met $\varnothing \geq 50$ mm.</p> <p>2 Biedt bescherming tegen het binnendringen van vaste elementen met $\varnothing \geq 12$ mm.</p> <p>3 Biedt bescherming tegen het binnendringen van vaste elementen met $\varnothing \geq 2,5$ mm.</p> <p>4 Biedt bescherming tegen het binnendringen van vaste elementen met $\varnothing \geq 1$ mm.</p> <p>5 Biedt bescherming tegen stof.</p> <p>6 Biedt volledige bescherming tegen stof.</p>	<p>La prima cifra (IP x...) indica la protezione del sistema contro l'ingresso di corpi solidi.</p> <p>0 Non protetto</p> <p>1 Protetto contro l'ingresso di corpi solidi con $\varnothing \geq 50$ mm.</p> <p>2 Protetto contro l'ingresso di corpi solidi con $\varnothing \geq 12$ mm.</p> <p>3 Protetto contro l'ingresso di corpi solidi con $\varnothing \geq 2,5$ mm.</p> <p>4 Protetto contro l'ingresso di corpi solidi con $\varnothing \geq 1$ mm.</p> <p>5 Protetto contro la polvere.</p> <p>6 Totalmente protetto contro la polvere.</p>	<p>Το πρώτο νούμερο (IP x...) υποδεικνύει την προστασία της συσκευής κατά της διείσδυσης στερεών αντικειμένων.</p> <p>0 Χωρίς προστασία</p> <p>1 Με προστασία κατά της διείσδυσης στερεών αντικειμένων διαμέτρου $\varnothing \geq 50$ mm</p> <p>2 Με προστασία κατά της διείσδυσης στερεών αντικειμένων διαμέτρου $\varnothing \geq 12$ mm</p> <p>3 Με προστασία κατά της διείσδυσης στερεών αντικειμένων διαμέτρου $\varnothing \geq 2,5$ mm</p> <p>4 Με προστασία κατά της διείσδυσης στερεών αντικειμένων διαμέτρου $\varnothing \geq 1$ mm</p> <p>5 Με προστασία κατά της σκόνης</p> <p>6 Με πλήρη προστασία κατά της σκόνης</p>
<p>Die zweite Ziffer (IP ...y) gibt den Schutz des Apparats gegen Regen an.</p> <p>0 Nicht geschützt.</p> <p>1 Geschützt gegen vertikal fallende Wassertropfen.</p> <p>2 Geschützt gegen Regenfall mit einem Winkel von max. 15° über die aleanSenkrechte.</p> <p>3 Geschützt gegen Regenfall mit einem Winkel von max. 60° über die Senkrechte.</p> <p>4 Geschützt gegen Spritzer und Schutz gegen Wasser.</p> <p>5 Geschützt gegen Wasserschauer.</p> <p>6 Geschützt gegen starke Wasserschauer.</p> <p>7 Geschützt gegen zeitweilige Überschwemmungen.</p> <p>8 Geschützt bei länger anhaltendem Eintauchen.</p>	<p>Het tweede cijfer (IP ...y) geeft de beschermingsgraad van het apparaat tegen de regen weer.</p> <p>0 Biedt geen bescherming</p> <p>1 Biedt bescherming tegen het verticaal neerkomen van waterdruppels.</p> <p>2 Biedt bescherming tegen regen met een max. hoek van 15° over verticaal.</p> <p>3 Biedt bescherming tegen regen met een max. hoek van 60° over verticaal.</p> <p>4 Biedt bescherming tegen spetters en tegen water.</p> <p>5 Biedt bescherming tegen waterstralen.</p> <p>6 Biedt bescherming tegen krachtige waterstralen.</p> <p>7 Biedt bescherming tegen tijdelijke overstromingen.</p> <p>8 Biedt bescherming tegen langdurige onderdompelingen.</p>	<p>La seconda cifra (IP ...y) indica la protezione del sistema contro la pioggia.</p> <p>0 Non protetto</p> <p>1 Protetto contro la caduta verticale di gocce d'acqua.</p> <p>2 Protetto contro la pioggia con angolo max. di 15° sulla verticale.</p> <p>3 Protetto contro la pioggia con angolo max. di 60° sulla verticale.</p> <p>4 Protetto contro gli spruzzi e l'ingresso di acqua.</p> <p>5 Protetto contro i getti d'acqua.</p> <p>6 Protetto contro i getti potenti d'acqua.</p> <p>7 Protetto contro inondazioni temporanee.</p> <p>8 Protetto contro le immersioni prolungate.</p>	<p>Το δεύτερο νούμερο (IP ...y) υποδεικνύει την προστασία της συσκευής κατά της βροχής.</p> <p>0 Χωρίς προστασία</p> <p>1 Με προστασία κατά της κάθετης πτώσης σταγόνων νερού</p> <p>2 Με προστασία κατά της βροχής με μέγιστη γωνία 15° επί καθέτου</p> <p>4 Με προστασία κατά των ππισισμάτων και προστασία νερού</p> <p>5 Με προστασία κατά της ροής νερού</p> <p>6 Με προστασία κατά της έντονης ροής νερού</p> <p>7 Με προστασία κατά των παροδικών πλημμυρών</p> <p>8 Με προστασία κατά της μακρόχρονης βύθισης</p>

RUS	CZ	BL	PL
<p>Первая цифра (IP x...) указывает на защиту прибора от проникновения твердых тел.</p> <p>0 Не защищен</p> <p>1 Защищен от проникновения твердых тел $\varnothing \geq 50$ мм</p> <p>2 Защищен от проникновения твердых тел $\varnothing \geq 12$ мм</p> <p>3 Защищен от проникновения твердых тел $\varnothing \geq 2,5$ мм</p> <p>4 Защищен от проникновения твердых тел $\varnothing \geq 1$ мм</p> <p>5 Защищен от пыли</p> <p>6 Полностью защищен от пыли</p>	<p>První číslice (IP x...) označuje stupeň ochrany přístroje proti průniku pevných částic.</p> <p>0 Nechráněno</p> <p>1 Chráněno proti průniku pevných částic s $\varnothing \geq 50$ mm</p> <p>2 Chráněno proti průniku pevných částic s $\varnothing \geq 12$ mm</p> <p>3 Chráněno proti průniku pevných částic s $\varnothing \geq 2,5$ mm</p> <p>4 Chráněno proti průniku pevných částic s $\varnothing \geq 1$ mm</p> <p>5 Chráněno proti prachu</p> <p>6 Kompletně chráněno proti prachu</p>	<p>Първата цифра (IP x...) означава защита на уреда от попадане на твърди тела.</p> <p>0 Без защита</p> <p>1 Защита от попадане на твърди тела с $\varnothing \geq 50$ mm</p> <p>2 Защита от попадане на твърди тела с $\varnothing \geq 12$ mm</p> <p>3 Защита от попадане на твърди тела с $\varnothing \geq 2,5$ mm</p> <p>4 Защита от попадане на твърди тела с $\varnothing \geq 1$ mm</p> <p>5 ащита от прах</p> <p>6 Изцяло защитен от прах</p>	<p>Pierwsza cyfra (IP x...) oznacza zabezpieczenie urządzenia przed wnikaniem ciał stałych.</p> <p>0 Niezabezpieczono</p> <p>1 Zabezpieczono przed wnikaniem ciał stałych za pomocą $\varnothing \geq 50$ mm</p> <p>2 Zabezpieczono przed wnikaniem ciał stałych za pomocą $\varnothing \geq 12$ mm</p> <p>3 Zabezpieczono przed wnikaniem ciał stałych za pomocą $\varnothing \geq 2,5$ mm</p> <p>4 Zabezpieczono przed wnikaniem ciał stałych za pomocą $\varnothing \geq 1$ mm</p> <p>5 Zabezpieczono przed pyłem</p> <p>6 Całkowicie zabezpieczono przed pyłem</p>
<p>Вторая цифра (IP ...y) указывает на защиту прибора от воды.</p> <p>0 Не защищен</p> <p>1 Защищен от попадания вертикальных капель воды</p> <p>2 Защищен от дождевых струй под углом до 15° по вертикали</p> <p>4 Защищен от брызг и попадания воды</p> <p>5 Защищен от потоков воды</p> <p>6 Защищен от сильных потоков воды</p> <p>7 Защищен от проникновения воды при временном затоплении</p> <p>8 Защищен от проникновения воды при длительном погружении.</p>	<p>Druhá číslice (IP ...y) označuje ochranu proti vnikání vlhkosti.</p> <p>0 Bez ochrany.</p> <p>1 Ochrana před svisle kapající vodou.</p> <p>2 Ochrana před vodou kapající se sklonem do 15°.</p> <p>3 Ochrana před vodou dopadající se sklonem 60° (dešti).</p> <p>4 Ochrana před stříkající vodou.</p> <p>5 Ochrana před tryskající vodou (tlakovou vodou).</p> <p>6 Ochrana před intenzivně tryskající vodou.</p> <p>7 Ochrana při dočasném ponoření.</p> <p>8 Ochrana při trvalém ponoření.</p>	<p>Втората цифра (IP ...y) указва нивото на защита от влага.</p> <p>0 не е защитен</p> <p>1 защитен от капеща вода</p> <p>2 защитен от капеща вода под наклон до 15°</p> <p>3 защитен от пръски вода</p> <p>4 защитен от пръскаща вода</p> <p>5 защитен от водна струя</p> <p>6 защитен срещу обилни валежи</p> <p>7 защитен от ефекта на потапяне</p> <p>8 защитен при потапяне във вода</p>	<p>Druga z cyfr kodu (IP ...y) oznacza stopień ochrony przed wilgocią.</p> <p>0 brak ochrony</p> <p>1 chronione przed kroplami wody (kapiącymi pionowo)</p> <p>2 ochrona przed kroplami wody padającymi pod kątem 15° z każdej strony</p> <p>3 ochrona przed natryskującą wodą</p> <p>4 ochrona przed rozbryzującą się wodą</p> <p>5 ochrona przed strumieniami wody</p> <p>6 ochrona przed dużymi strumieniami wody</p> <p>7 ochrona przed zanurzeniem krótkotrwałym w wodzie</p> <p>8 ochrona przed całkowitym zalaniem wodą (zanurze niem ciągłym)</p>

General information

ENG	ES	FR
<p>The technical information detailed in our catalogue can be modified in order to improve the features or design of our products.</p> <p>Faro Barcelona keeps the right to cancel or modify any model without prior notice and without any cause for complaints.</p> <p>The conditions, technical characteristics and prices of the products that appear in this catalogue are the effective ones in the date of impression of the catalogue except for typographical error and are subject to possible changes.</p> <p>The catalogue prices are public prices.</p> <p>RATES DO NOT INCLUDE VAT.</p> <p>Price list not valid for Italy and Switzerland.</p> <p>Returned goods shall only be accepted, after prior notice being given to LOREFAR, on the grounds of being defective and never on the basis of broken glass or missing parts. In such cases, please contact us so that we can send you the required parts as a matter of urgency.</p> <p>Exchanges or returns of goods in good condition will not be accepted.</p> <p>In the event of express acceptance by LOREFAR, a 20% charge shall be incurred, on receipt and checking, for depreciation and classification of the goods.</p>	<p>La información referente a nuestros productos puede ser modificada con el fin de mejorar las características técnicas o de diseño.</p> <p>Faro Barcelona se reserva el derecho de anular o modificar cualquier modelo sin previo aviso y sin que sea motivo de reclamaciones.</p> <p>Las condiciones, características y precios de los productos que aparecen en este catálogo son los vigentes en la fecha de impresión del catálogo salvo error tipográfico y están sujetos a posibles modificaciones.</p> <p>Los precios mostrados son precios de venta al público (PVP).</p> <p>IVA NO INCLUIDO EN TARIFA</p> <p>Tarifa no válida para Italia y Suiza.</p> <p>Previa comunicación a Lorefar sólo se aceptará la mercancía devuelta por defectuosa, nunca por cristales rotos o falta de algún componente.</p> <p>En estos casos rogamos se pongan en contacto con nosotros para enviarnos urgentemente las piezas requeridas.</p> <p>No se admitirán cambios ni devoluciones de mercancía en buen estado.</p> <p>En caso de aceptación explícita por parte de Lorefar, a su recepción y comprobación se emitirá un cargo del 20% en concepto de depreciación y clasificación de la mercancía.</p>	<p>L'information qui se réfère à nos produits peut être modifiée afin d'améliorer les caractéristiques technique ou de design.</p> <p>Faro Barcelona se réserve le droit d'annuler ou de modifier n'importe quel modèle sans préavis et sans que cela soit motif de réclamations.</p> <p>Les conditions, caractéristiques et prix des produits qui apparaissent dans ce catalogue sont celles en vigueur à la date d'impression du catalogue sauf erreur typographique et sont susceptible d'être modifiées ultérieurement.</p> <p>Les prix du catalogue son les prix de vente public .</p> <p>IVA NON COMPRISE DANS LE TARIF.</p> <p>Liste de prix pas valable pour l'Italie et la Suisse.</p> <p>Seule sera acceptée en retour la marchandise défectueuse, et ce après communication à LOREFAR. LOREFAR n'acceptera jamais de retour pour du verre brisé ou pour l'absence d'un composant quelconque.</p> <p>Dans ces derniers cas, nous vous prions de vous mettre en contact avec nous afin que nous vous fassions parvenir dans les plus brefs délais les pièces nécessaires.</p> <p>La marchandise en bon état ne sera ni reprise ni échangée.</p> <p>En cas d'acceptation explicite de sa part, LOREFAR retiendra 20% au titre de la dépréciation et de la classification du produit.</p>
PT	GER	NL
<p>A informação referente aos nossos produtos pode ser modificada com o fim de melhorar as características técnicas ou de desenho.</p> <p>A Faro Barcelona reserva-se o direito de anular ou modificar qualquer modelo sem aviso prévio e sem que seja motivo de reclamações.</p> <p>As condições, características e preços dos produtos que aparecem neste catálogo são os vigentes na data de impressão do catálogo salvo erro tipográfico e estão sujeitos a possíveis modificações.</p> <p>Os preços mostrados são preços de venda ao público (PVP).</p> <p>IVA NÃO INCLUIDO NA LISTA DE PREÇOS</p> <p>Lista de preços não é válido para a Itália e Suíça.</p> <p>Mediante comunicação prévia à Lorefar, apenas se aceitará a mercadoria devolvida por defeito, nunca por vidros partidos ou falta de algum componente.</p> <p>Nestes casos pedimos que entrem em contacto conosco para lhes enviarmos urgentemente as peças requeridas.</p> <p>Não serão admitidas alterações nem devoluções de mercadoria em bom estado.</p> <p>Em caso de aceitação explícita por parte da Lorefar, na sua recepção e comprovação emitir-se-á um débito de 20% a título de depreciação e classificação da mercadoria.</p>	<p>Die Information über unsere Produkte kann im Zusammenhang mit den Verbesserungen ihrer technischen Eigenschaften und ihres Designs jederzeit geändert werden.</p> <p>Faro Barcelona behält sich das Recht vor, seine Modelle jederzeit und ohne vorherige Ankündigung vom Markt zu nehmen, ohne dass sich daraus ein Anrecht auf Beschwerden ableiten könnte.</p> <p>Die Bedingungen, Eigenschaften und Preise der Produkte in diesem Katalog gelten zum Datum der Drucklegung des Katalogs vorbehaltlich Druckfehler und können jederzeit geändert werden. Diese Preise gelten für den Direktverkauf an den Kunden.</p> <p>DIE MEHRWERTSTEUER IST NICHT IN DEN PREISEN EINGESCHLOSSEN</p> <p>Preisliste gilt nicht für Italien und die Schweiz.</p> <p>Nach vorheriger Kommunikation kann Lorefar die Rücklieferung von schadhafter Ware akzeptieren, jedoch niemals wegen beschädigten Glasteilen oder fehlenden Komponenten.</p> <p>In letzteren Fällen setzen Sie sich bitte zwecks schneller Zusage der notwendigen Teile in Verbindung.</p> <p>Wir tauschen keine Waren in gutem Zustand um oder nehmen sie zurück.</p> <p>Bei ausdrücklicher Annahme durch Lorefar nach Erhalt und Überprüfung stellen wir Ihnen 20% des Preises für Wertverminderung und Handhabung der Ware in Rechnung.</p>	<p>De informatie over onze producten kan gewijzigd worden met als doel de technische eigenschappen of het design te verbeteren.</p> <p>Faro Barcelona behoudt zich het recht voor onaangekondigd modellen te schrappen of te wijzigen en zonder dat dit aanleiding tot een klacht vormt.</p> <p>De voorwaarden, eigenschappen en prijzen van de producten in deze catalogus zijn geldig op het moment van druk van de catalogus tenzij sprake is van een drukfout.</p> <p>Zij zijn onderhevig aan mogelijke wijzigingen.</p> <p>De getoonde prijzen betreffen verkoopprijzen.</p> <p>Btw NIET BIJ DE PRIJS INBEGREPEN</p> <p>Tarifa niet geldig voor Italië en Zwitserland.</p> <p>Lorefar aanvaardt uitsluitend defecte teruggezonden goederen nadat zij hierover van tevoren op de hoogte is gesteld.</p> <p>Dit geldt niet voor gebroken glas of het ontbreken van onderdelen.</p> <p>In deze gevallen wordt u verzocht met ons contact op te nemen zodat wij u zo snel mogelijk de gewenste onderdelen kunnen toezenden.</p> <p>Ruilen of terugsturen van goederen in correcte staat is niet toegestaan.</p> <p>In geval van uitdrukkelijke aanvaarding door Lorefar wordt bij ontvangst en controle een heffing van 20% voor waardevermindering en classificatie van de goederen toegepast.</p>
ITA	GRK	RUS
<p>La informazione che si riferisce ai nostri articoli può essere soggetta a modifiche con il fine di migliorare le caratteristiche, tecniche o di design, dei nostri prodotti.</p> <p>Faro Barcelona si riserva il diritto di annullare o modificare qualsiasi modello senza previo avviso e senza che sia motivo di reclami.</p> <p>Le condizioni, caratteristiche e prezzi dei prodotti che compaiono in questo catalogo sono quelli vigenti alla data della stampa del catalogo ad eccezione di errori tipografici e sono soggetti a possibili modificazioni.</p> <p>I prezzi indicati sono prezzi di vendita al pubblico.</p> <p>IVA NON INCLUSA IN LISTINO.</p> <p>Il listino non è valido per l'Italia e la Svizzera.</p> <p>LOREFAR accetta previa comunicazione, solo la merce restituita perché difettosa; in nessun caso accetterà la merce restituita per presenza di vetri rotti o per mancanza di qualche componente.</p> <p>In questi casi vi preghiamo di contattarci per potervi mandare al più presto i pezzi richiesti.</p> <p>Non si effettuano cambi né si ammettono restituzioni di merci in buono stato.</p> <p>In caso di accettazione esplicita da parte di LOREFAR, al momento del ricevimento e della verifica della merce si emetterà un addebito del 20% a titolo di deprezzamento e classificazione.</p>	<p>Οι πληροφορίες σχετικά με τα προϊόντα μας ενδέχεται να τροποποιηθούν με στόχο τη βελτίωση των τεχνικών χαρακτηριστικών ή του σχεδίου.</p> <p>Η Faro Barcelona διατηρεί το δικαίωμα ακύρωσης ή τροποποίησης οποιουδήποτε μοντέλου χωρίς προηγούμενη προειδοποίηση και χωρίς αυτό να αποτελεί αιτία απαίτησης επιστροφής χρημάτων.</p> <p>Οι όροι, τα χαρακτηριστικά και οι τιμές των προϊόντων που παρουσιάζονται σε αυτόν τον κατάλογο είναι αυτά που ισχύουν κατά την ημερομηνία της εκτύπωσης του καταλόγου, εκτός τυπογραφικών λαθών, και υπόκεινται σε αλλαγές.</p> <p>Οι τιμές που εμφανίζονται είναι τιμές λιανικής.</p> <p>Ο ΦΠΑ ΔΕΝ ΣΥΜΠΕΡΙΛΑΜΒΑΝΕΤΑΙ ΣΤΗΝ ΤΙΜΗ</p> <p>Μετά από συνεννόηση με τη Lorefar, γίνονται αποδεκτές επιστροφές μόνο αν πρόκειται για ελαττωματικά εμπορεύματα και όχι για θραύση κρυστάλλων ή απουσία κάποιου στοιχείου.</p> <p>Στις περιπτώσεις αυτές, παρακαλούμε να έρθετε σε επαφή μαζί μας για να σας στείλουμε επιγώντως τα απαιτούμενα μέρη.</p>	<p>Информация относящаяся к нашей продукции может быть модифицирована с целью улучшить технические или внешние характеристики.</p> <p>Faro Barcelona сохраняет за собой право аннулировать или модифицировать любую модель без предупреждения и без того что это послужит причиной для жалоб.</p> <p>Ден γίνονται αποδεκτές αλλαγές ή επιστροφές για εμπορεύματα σε καλή κατάσταση.</p> <p>Σε περίπτωση ρητής αποδοχής εκ μέρους της Lorefar, κατά την παραλαβή και τον έλεγχο τους θα πραγματοποιηθεί χρέωση 20% για έξοδα απόδοσης και ταξινόμησης των εμπορευμάτων.</p> <p>Условия, характеристики и цены на изделия, указанные в данном каталоге, действительны на дату его выпуска, за исключением опечаток в каталоге, и могут быть изменены.</p> <p>В каталоге указаны розничные цены.</p> <p>БЕЗ УЧЕТА НДС</p> <p>В соответствии с правилами, компания Lorefar принимает возврат изделий только при наличии дефектов, но ни в коем случае не при разбитии стекла или отсутствии какой-либо детали.</p> <p>В таком случае, пожалуйста, свяжитесь с нами, чтобы мы отправили вам необходимые детали.</p> <p>Товар в рабочем состоянии не подлежит обмену или возврату.</p> <p>В случае подтверждения компанией Lorefar наличия дефектов, после возврата и проверки, начисляется 20% стоимости с учетом амортизации и классификации товаров.</p>
CZ	BL	PL
<p>Technické informácie uvedené v katalogu mohou být modifikovány za účelem zdokonalování vlastností svítidel nebo jejich designu.</p> <p>Producent Faro Barcelona si vyhrazuje právo konstrukčních změn nabízených modelů bez předcházejícího oznámení a tato skutečnost nemůže být předmětem jakéhokoliv stížnosti či reklamace.</p> <p>Podmínky, technické specifikace a ceny produktů uvedených v katalogu jsou platné ke dni vydání katalogu.</p> <p>Producent si vyhrazuje právo konstrukčních změn nabízených modelů, pokud tyto nepovedou k zásadním změnám charakteru výrobků.</p> <p>Informace z tohoto katalogu postarádají platnosti v den vydání katalogu nového.</p> <p>VŠECHNY CENY JSOU UVEDENY BEZ DPH.</p> <p>Zboží může být vráceno pouze po předchozím souhlasu od společnosti PAXI, na základě poruchy nebo vady ovšem nikdy na základě poškozeného skla nebo chybějícího dílu.</p> <p>V takových případech nás, prosím, kontaktujte, abychom Vám mohli požadované části svítidel urgentně zaslat.</p> <p>Výměny nebo vrácení zboží v dobrém technickém stavu je nepřijatelné.</p>	<p>Техническата информация, представена в нашият каталог, може да бъде променяна с цел да подобри представянето или дизайна на продуктите.</p> <p>Фаро Барселона си запазва правото да отменя или променя всеки модел без предварително осведомяване и без това да се счита причина за оплаквания.</p> <p>Условията, техническите характеристики и цените на продуктите показани в този каталог са ефективни към датата на отпечатването на каталога, с изключение на грешки при отпечатване и са обект на възможни промени.</p> <p>Цените в каталога са публичните цени.</p> <p>ЦЕНИТЕ НЕ ВКЛЮЧВАТ ДДС.</p> <p>Връщане на закупена стока ще да бъдат приети единствено след писмено осведомяване на ЛОРЕФАР на основание дефекти и в никакви случаи на основание случено стъкло или липсващи части.</p> <p>В такива случаи моля свържете се с нас, за да ви изпратим липсващите части по спешност.</p> <p>Размяна или връщане на стока в добро състояние няма да бъде извършвана.</p> <p>В случай на спешно приемане от ЛОРЕФАР 20 % такса ще бъде наложена за приемане и проверка, за обезценяване и класификация на продуктите.</p>	<p>Informacje techniczne wyszczególnione w naszym katalogu mogą być modyfikowane w celu poprawienia właściwości lub wzornictwa produktów.</p> <p>Faro Barcelona ma prawo do anulowania i modyfikowania każdego z modeli bez uprzedniego infomowania i nie przyjmuje skarg z tego tytułu.</p> <p>Warunki, opis techniczny oraz ceny artykułów, które pojawiają się w katalogu są aktualne do czasu przedruku katalogu za wyjątkiem pomylek w druku, które podlegają ewentualnej zmianie.</p> <p>Ceny w katalogu są cenami publicznymi.</p> <p>CENY NIE ZAWIERAJĄ STAWKI VAT.</p> <p>Ewentualne zwroty mogą być zaakceptowane po uprzedniej zgodzie przez Lorefar na podstawie stwierdzenia, że są wadliwe, nigdy nie przyjmowane są zwroty artykułów, z powodu złuszczenia szkła czy brakujących części.</p> <p>W tym przypadku prosimy o kontakt w celu wysłania potrzebnych części w trybie natychmiastowym.</p> <p>Wymiany lub zwroty artykułów w dobrym stanie nie będą zaakceptowane.</p> <p>W przypadku wyrażonej akceptacji przez Lorefar, 20% opłaty może być poniesione na otrzymanie i sprawdzenie, w celu sklasyfikowania uszkodzenia artykułu.</p>

fan



indoor



outdoor



bulbs



professional

Ref.	Pag.	Ref.	Pag.	Ref.	Pag.
19028	284	70226	278	70547	189
19029	284	70227	278	70552	178
19030	284	70397	230	70556	179
19031	285	70398	231	70560	179
19032	285	70399	231	70561	239
19034	285	70400	240	70562	239
19035	285	70401	241	70564	189
19036	285	70402	245	70565	175
19037	285	70403	244	70566N	171
19038	285	70404	172	70567N	171
19039	285	70449	253	70568	171
R 7R143	112	70450	237	70569	171
43070	288	70451	237	70573	197
46060	288	70453	253	70574	213
46061	288	70455	257	70577	163
46067	257	70456	257	70578	163
66208	39	70458N	253	70588	255
66209	39	70459N	253	70589	255
66210	41	70460	237	70591	257
66211	41	70462N	252	70592N	255
66212	39	70463N	252	70593	255
66213	39	70469	277	70593N	255
66214	41	70472	257	70596	261
66215	41	70474	257	70600	246
70021	275	70475	257	70606	245
70025	267	70476	257	70607	245
70120	275	70477	21	70629	105
70122	274	70478	21	70630	105
70137	271	70479	21	70631	105
70138	271	70480	21	70632	241
70139	273	70484	25	70633	241
70140	273	70485	25	70634	169
70146	233	70486	25	70635	165
70147	233	70487	25	70636	185
70148	233	70492	26	70637	168
70150	271	70498	27	70639	215
70151	277	70499	27	70644	161
70152	243	70508	192	70645	161
70153	243	70544	259	70646	161
70154	235	70545	259	70647	161
70155	235	70546	189	70649	270

Ref.	Pag.	Ref.	Pag.	Ref.	Pag.
70655	193	70818	209	71152	61
70656	193	70819	185	71153	61
70657	191	70820	184	71154	61
70658	191	70821	213	71155	61
70659	191	70822	167	71156	61
70689	200	70823	167	71197	183
70690	216	70887	197	71198	141
70694	173	70888	201	71199	141
70696	203	70899	201	71205	33
70697	203	70998	207	71206	31
70702	203	70999	207	71207	31
70714	202	71000	223	71208	31
70715	200	71001	223	71240	225
70719	217	71002	220	71241	225
70720	197	71003	220	71260	222
70722	217	71004	220	71261	222
70723	217	71010B	224	71270	222
70724	215	71011N	224	71271	222
70749	196	71050	187	71352	93
70753	143	71051	187	71353	175
70754	143	71109	128	71354	246
70755	143	71110	128	71355	247
70756	143	71111	131	71357	63
70758	137	71112	131	71358	63
70760	117	71113	129	71359	63
70761	117	71114	129	71362	157
70766	95	71116	133	71363	93
70767	95	71117	133	71365	195
70768	95	71118	132	71366	93
70769	187	71128	128	71367	93
70770	187	71129	128	71368	173
70771	137	71138	130	71369	173
70799	211	71139	130	71372	211
70802	173	71140	123	71374	211
70806	213	71141	123	71375	237
70808	172	71142	123	71382	269
70811	169	71143	122	71383	269
70812	169	71145	121	71385	177
70813	169	71146	121	71388	181
70816	165	71147	209	71389	269
70817	185	71151	61	71390	269

Ref.	Pag.	Ref.	Pag.	Ref.	Pag.
71424	218	72002	221	73256	112
71476	262	72004	199	73260	115
71480	247	72010	223	73261	115
71481	247	72011	223	73315	219
71482	247	72012	223	73431	125
71482	289	72013	223	73432	125
71483	259	72020	225	73434	125
71488	263	72022	225	73436	127
71488N	263	72070	223	73438	127
71489N	263	72071	223	73440	145
71490	247	72260	205	73450	145
71491	247	72261	205	73456	126
71495	261	72265	199	73460	145
71496N	251	72266	199	74261	219
71497	249	72267	175	74349	83
71497N	249	72269	172	74350	81
71498N	251	72270	195	74351	81
71499N	249	72271	183	74353	80
71500	225	72272	186	74355	81
71501	225	72280	205	74356	82
71506	258	72281	204	74357	82
71516	153	72283	176	74358	83
71517	153	72284	177	74359	83
71519	152	72298	142	74369	85
71526	154	72299	139	74370	85
71527	154	72310	139	74387	119
71528	276	72400	99	74388	119
71536	151	72401	99	74389	119
71537	151	72402	101	74390	118
71550	221	72403	101	74391	87
71551	221	73100	279	74392	87
71554	221	73101	281	74393	87
71556	19	73111	279	74394	87
71562	17	73112	279	74395	86
71563	17	73115	289	74400	155
71564	17	73116	289	74401	156
71606	219	73131	281	74407	58
71607	159	73150	281	74408	59
71608	159	73196	145	74409	59
72000	221	73254	113	74410	59
72001	221	73255	113	74411	59

Ref.	Pag.	Ref.	Pag.	Ref.	Pag.
74414	181	74450	89	75526	97
74419	162	74451	89	75527	97
74422	23	74452	89	75529	37
74423	22	74996	107	75530	37
74424	23	74997	109	75531	37
74427+74428	78	74998	107	75533	37
74427+74429	75	74999	109	75536	35
74427+74430	71	75000	107	75537	35
74427+74437	67	75001	109	75538	35
74427+74438	67	75002	107	75800	288
74432+74428	77	75003	109	75801	288
74432+74429	73	75100	57	98101050	288
74432+74430	68	75101	57		
74432+74437	64	75102	57		
74433+74428	77	75103	57		
74433+74429	73	75106	55		
74433+74430	69	75108	55		
74433+74437	65	75500	51		
74433+74438	65	75501	51		
74434+74428	77	75502	51		
74434+74429	73	75503	51		
74434+74430	69	75504	53		
74434+74437	65	75505	53		
74434+74438	65	75506	53		
74435+74428	79	75507	53		
74435+74429	74	75509	49		
74435+74430	70	75510	49		
74435+74438	67	75511	49		
74436+74428	79	75512	49		
74436+74429	75	75513	49		
74436+74430	71	75514	111		
74436+74438	67	75515	110		
74440	45	75516	111		
74441	45	75518	91		
74442	45	75519	91		
74443	47	75520	91		
74443L	47	75521	138		
74444	47	75522	103		
74446	43	75523	103		
74447	43	75524	102		
74448	43	75525	103		

Mod.	Pag.
Aday [new]	161
Agra	143
Alfa [new]	266
Alp	88
Amon	163
Áncora	156
Apolo	275
Aran	271
Argot	218
Aristo	145
Askot	225
Aton	271
Baco	185
Balda	27
Balder	277
Bastet	243
Beret	102
Bird	48
Blind	169
Blub's	68
Boletus	86
Bonn	203
Boo	26
Bracket [new]	186
Cabo	207
Canon	171
Capri	175
Cartago	112
Carter	245
Cat [new]	16
Cela	204
Ceres	158
Chandra	142
Citrus	239
Coal	195
Cobo	172
Code	154

Mod.	Pag.
Crata	171
Cripta	220
Crosby	253
Cross	80
Curtis	252
Dado	219
Dakron	217
Dakyu	217
Das	90
Datna	44
Derby	221
Didot	173
Dorval	205
Dragma	157
Edel	257
Ele	162
Ellen	100
Erio	195
Esca	247
Estay	223
Estoril	122
Fedon	202
Fenes	199
Filter	237
Flux [new]	270
Future	153
Garten	279
Gera	271
Gina	92
Giza	94
Grant	193
Grow [new]	30
Half [new]	150
Hepta	225
Horus	235
Ina [new]	215
Inari	184

Mod.	Pag.
Indi	241
Ion	177
Jaipur	137
Jarrett [new]	20
Kamal	179
Kami	176
Keenan	189
Klamp	58
Kubick	200
Lace	169
Lacre	173
Landai	240
Latina	173
Led -15 [new]	259
Led -16	259
Led -18	249
Led -19	261
Ling	169
Lio	261
Liso	247
Long	110
Marat	178
Mare	165
Mera [new]	215
Metric	237
Mila [new]	137
Mini Carter	245
Mini Contra	246
Mini Geo	247
Mini Racing	244
Mirto	223
Mistu	76
Mitra	120
Mol	197
Moon	64
Muffin	72
Must [new]	191

Mod.	Pag.
Mysore	262
Naomi	185
Nase [new]	231
Natron	197
Náutica	128
Nava	274
Naya	141
Neftis	177
Negus	203
Neo	104
Newport	60
Nisha	185
Nono	222
Noray	207
Nuk	24
Num [new]	183
Olan [new]	168
Olot [new]	211
Onda	275
Onze	116
Óvalo	223
Papo	175
Paris	124
Parma	219
Path [new]	192
Pistón	172
Plec [new]	38
Pola	281
Proa	155
Project	268
Racing	245
Radha	165
Radio	225
Rondo	224
Rounder	98
Rustic	209
Saga	96

Mod.	Pag.
Sail	62
Salt	257
Sedna	233
Sentinel	56
Sete	138
Seth	278
Shelby [new]	34
Sobek	277
Sol	118
Sor	199
Sora	139
Steps	50
Store	237
Sula	241
Suma	196
Sun	167
Surat	139
Suria	255
Taima [new]	181
Tami [new]	211
Tane	172
Taro	253
Tarraco	114
Tasa	213
Tau	42
Teba [new]	181
Tecno -1 [new]	259
Tecno -6	263
Tecno -8	258
Tejo	197
Terra	221
Tinia	175
Toluca [new]	187
Toni [new]	276
Tono	281
Toran	273
Tram [new]	36

Mod.	Pag.
Usagui [new]	187
Uve [new]	230
Verno	145
Versus	22
Vertice [new]	167
View	152
Visnu	209
Wally	219
West	201
Wilma	106
Yak	54
Yen	216
Zoe [new]	183

LOREFAR
c/Dinámica, 1
08755 Castellbisbal
Barcelona, Spain
faro@lorefar.com
www.faro.es

Spain / Portugal / Andorra
Phone: +34 937 723 949 / 902 165 166
Fax: +34 937 720 018
E-mail: faro@lorefar.com

Export
Phone: +34 937 723 965
Fax: +34 937 723 967

Contact us from anywhere
E-mail: france@faro.es
italia@faro.es
middleeast@faro.es
europe@faro.es
america@faro.es
africa@faro.es
asiapacific@faro.es



faro.es