



OUT DOOR

LIGHTING
EXTERIOR /
EXTÉRIEUR 2015

© LOREFAR, 2015

Referencia/Reference/Référence:

A0236

Primera edición / First edition / Première édition:

Diseño catálogo / Catalogue designer / Conception du catalogue:

Fotografía / Photography / Photographie:

Impresión / Printed by / Imprimer:

Enero / January / Janvier 2015

Faro Barcelona (Joel Polls), Empiezapori Comunicació Gràfica i Web

Guillem FH

INGOPRINT

[GREEN
I N N O V A T I O N]

**Join
us!**     
www.faro.es/blog

why us

We are a team consisting of people, with international and highly professional profiles, covering all phases of the lighting and fan business, from design and manufacturing to distribution. We offer a comprehensive and global “package deal”.

Somos un equipo de personas, con vocación internacional y alta profesionalidad, que cubre todas las fases del negocio de la iluminación y la ventilación, desde el diseño y la fabricación hasta la distribución, con una oferta integrada y global.

Nous sommes une équipe de professionnels à visée internationale et nous couvrons toutes les étapes du secteur du luminaire et de la ventilation, depuis la conception et la fabrication jusqu'à la distribution.

Siamo un gruppo di persone con vocazione internazionale, e alta professionalità, che coprono tutte le fasi dell'illuminazione e della ventilazione, dal disegno, alla fabbricazione, fino alla distribuzione, con una offerta integrata e globale.



+90 Countries in which we operate.



Países en los que estamos presentes.

Pays dans lesquels nous sommes présents.

Paesi nei quali operiamo.



+3.000



Lighting & fan solutions.

Soluciones en iluminación y ventilación.

Solutions en éclairage et illumination.

Soluzioni di illuminazione e ventilazione.

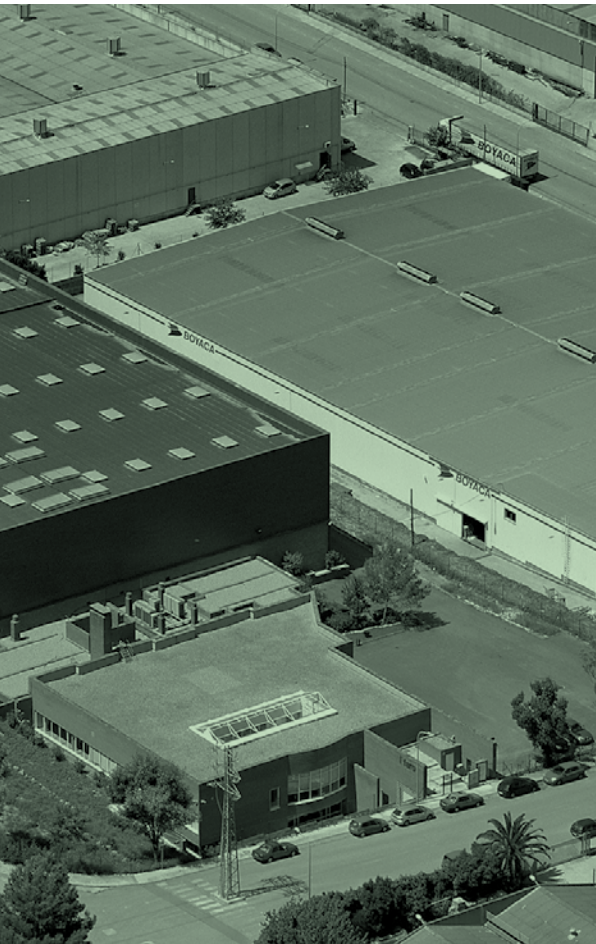

+60

Years experience.

Años de experiencia.

Ans d'expérience.

Anni di esperienza.

design ers

more than 350
registered products
ideas born in Barcelona.



Faro
Team



Estudi
Ribaudí



Manel
Lluscà



Pepe
Llaudet



Nahtrang



Marina
Milà



Jordi
Llopis



Jordi
Busquets

tAu [new]

by Manel Llusçà

An outdoor collection that is characterized by its sober and architectural lines. Tau presents a compact and solid design, making it a solution for highly aesthetic outdoor lighting.

Colección para exterior que se caracteriza por sus líneas sobrias y arquitectónicas. Tau presenta un diseño compacto y sólido, convirtiéndose en una solución altamente estética.

Collection pour intérieur qui se caractérise par sa ligne sobre et architectural. Tau présente un design compact et solide, se convertissant en une solution hautement esthétique pour l'illumination des extérieurs.



20
outdoor lighting
catalogue
2015

[new] post lamp

74446

dark grey
gris oscuro

1XE27 MAX 20W NOT INCL. [16467] [LED 17059]
DIE CAST ALUMINIUM+OPAL POLYCARBONATE/
ALUMINIO INYECTADO+POLICARBONATO OPAL
A++ to A / 100-240V - 50-60 Hz / 0.86 kg/1.90 lb

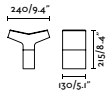

FINISH
ACABADO
FINITION
RIFINITURA



BULB &
CONSUMPTION
BOMBILLA Y
CONSUMO
AMPOULE ET
CONSOMMATION
LAMPADINA E
CONSUMO

[new] beacon

74447

dark grey
gris oscuro

1XE27 MAX 20W NOT INCL. [16467] [LED 17059]
DIE CAST ALUMINIUM+OPAL POLYCARBONATE/
ALUMINIO INYECTADO+POLICARBONATO OPAL
A++ to A / 100-240V - 50-60 Hz / 1.34 kg/2.95 lb

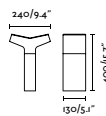

[new] beacon

74448

dark grey
gris oscuro

1XE27 MAX 20W NOT INCL. [16467] [LED 17059]
DIE CAST ALUMINIUM+OPAL POLYCARBONATE/
ALUMINIO INYECTADO+POLICARBONATO OPAL
A++ to A / 100-240V - 50-60 Hz / 1.51 kg/3.33 lb

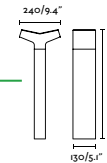

SIZES IN MM
MEDIDAS EN MM
DIMENSIONS EN MM
DIMENSIONI IN MM

series
series
séries
serie

21

ENGINE & DIFUSOR MATERIAL
MATERIAL DE LA ESTRUCTURA Y
DEL DIFUSOR
MATÉRIEL DE LA STRUCTURE ET
DU DIFUSSEUR
MATERIALE DEL DIFFUSORE E
DELLA STRUTTURA

REFERENCE
REFERENCIA
RÉFÉRENCE
RIFERIMENTO

TECHNIQUE INFORMATION: CLASS, IP
INFORMACIÓN TÉCNICA: CLASE, IP
INFORMATION TECHNIQUE: CLASSE, IP
INFORMAZIONE TECNICA, CLASSE, IP

p_264	ACCESSORIES ACCESORIOS ACCESSOIRES ACCESSORI
p_268	FARO COMMITMENT COMPROMISO FARO LENGAGEMENT FARO IMPEGNO FARO
p_270	PHOTOMETRICS FOTOMÉTRICAS PHOTOMÉTRIQUES FOTOMETRICHE
p_274	SYMBOLS SÍMBOLOS SYMBLES SIMBOLI
p_276	MATERIALS MATERIALES MATÉRIAUX MATERIALI
p_278	FINISHES ACABADOS FINITIONS RIFINITURE
p_279	RECESSED DRAINAGE DRENAJE EMPOTRABLES DRAINAGE D'ENCASTRABLES DRENAGGIO AD INCASSO



more info

p_279	BEACONS BALIZAS BALISES LAMPIONI BASSI
p_279	STAINLESS STEEL ACERO INOXIDABLE ACIER INOXYDABLE ACCIAIO INOSSIDABILE
p_280	IP INFORMATION INFORMACIÓN IP INFORMATION IP INFORMAZIONE IP
p_282	GENERAL INFORMATION INFORMACIÓN GENERAL INFORMATIONS GÉNÉRALES INFO GENERALE

WALL LAMPS

APLIQUES
APPLIQUES
LAMPADE DA PARETE

									
Alp p_69	Amon p_143	Amura p_197	Áncora p_140	Argot p_190	Askot p_197	Baco p_161	Beret p_83	Bird p_27	Blind p_146
									
Blub'S p_44	Boletus p_65	Bonn p_171	Brindisi p_113	Cabo p_179	Canon p_149	Capri p_153	Cela p_177	Ceres p_183	Coal p_167
									
Cobo p_150	Code p_138	Crata p_149	Cripta p_192	Cross p_57	Dado p_191	Das p_71	Datna p_23	Delta p_170	Derby p_193
									
Didot p_151	Dorval p_175	Dragma p_141	Driza p_188	Ele p_142	Ellen p_81	Erio p_167	Estay p_195	Estoril p_105	Fedon p_175
									
Fenes p_173	Flame p_173	Future p_137	Gina p_73	Giza p_75	Grant p_165	Grid p_170	Hepta p_198	Herm p_167	Inari p_160
									
Ion p_155	Joy p_145	Kamal p_158	Kami p_154	Keenan p_163	Klamp p_36	Kubick p_170	Lace p_147	Lacre p_151	Latina p_151
									
Leva p_165	Ling p_147	Long p_90	Marat p_157	Mare p_145	Maya p_177	Mirto p_195	Mistu p_53	Mitra p_103	Mol p_169
									
Moon p_40	Muffin p_48	Naomi p_161	Natron p_169	Náutica p_106	Neftis p_155	Negus p_175	Neo p_85	Newport p_39	Nisha p_161

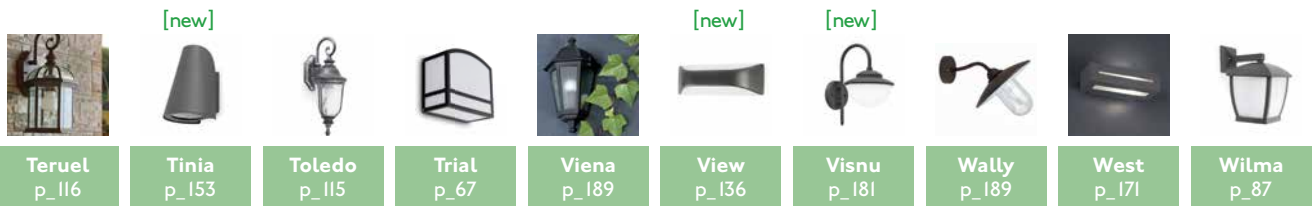
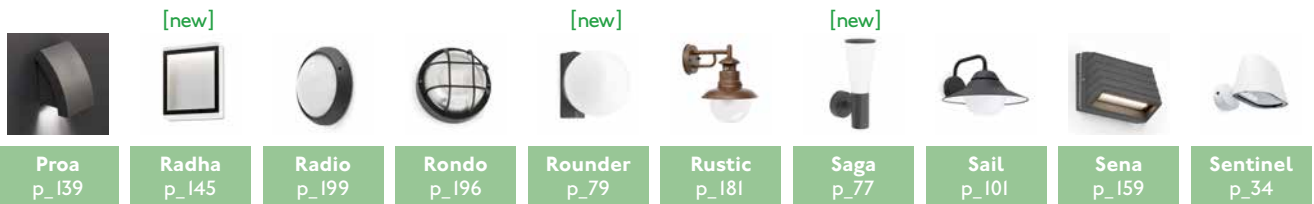















CEILING LAMPS

PLAFONES
PLAFONNIERS
PLAFONIERE



PENDANT LAMPS

COLGANTES
SUSPENSION
SOSPENSIONE

		[new] 							
Blub'S p_47	Cross p_60	Ellen p_81	Estoril p_105	Mistu p_54	Mitra p_103	Moon p_43	Muffin p_50	Náutica p_107	Newport p_39
									
Paris p_119	Sail p_101	Teruel p_117	Wilma p_87						

RECESSED

EMPOTRABLES
ENCASTRABLES
FARETTI

[new] 							[new] 	[new] 	
Bastet p_213	Carter p_215	Citrus p_209	Crosby p_221	Curtis p_221	Edel p_224	Esca p_216	Filter p_207	Horus p_205	Indi p_211
									
Landai p_210	Led-15 p_225	Led-16 p_225	Led-18 p_219	Led-19 p_226	Lio p_227	Liso p_217	Metric p_207	Mini Carter p_215	Mini Racing p_214
[new] 	[new] 			[new] 	[new] 		[new] 	[new] 	
MiniContra p_217	Mini-Geo p_217	Mysore p_228	Racing p_215	Sedna p_203	Store p_207	Sula p_211	Suria p_223	Taro p_223	Tecno-I p_225
									
Tecno-3 p_229	Tecno-6 p_227	Tecno-7 p_229	Tecno-8 p_229						

PROJECTORS

PROYECTORES
PROJECTEURS
PROIETTORI



Apolo
p_243



Aran
p_237



Aton
p_236



Gera
p_237



Hoki
p_245



Kara
p_240



Konic
p_242



Madol
p_241



Nava
p_244



Onda
p_244



Park
p_235



Pola
p_243



Project
p_232



Sansón
p_243



Toran
p_239

SPIKES

ESTACAS
PIQUETS
PICHETTI



Balder
p_247



Garda
p_248



Garten
p_251



Led-9
p_249



Nebel
p_249



Seth
p_247



Sobek
p_246



Spike
p_251



Tono
p_251

POST LAMPS

SOBREMUROS
BORNES
LAMPIONCINI SU MURO



Blub'S
p_45



Boletus
p_65



Brindisi
p_113



Cartago
p_93



Cross
p_57



Cross
p_61

[new]



Giza
p_75



Long
p_91



Mistu
p_53



Moon
p_41



Muffin
p_49



Paris
p_119



Sol
p_99



Tau
p_21



Teruel
p_117



Toledo
p_115



Trial
p_67



Wilma
p_89



Naya
p_125

OTHERS

OTROS
AUTRES
ALTRE

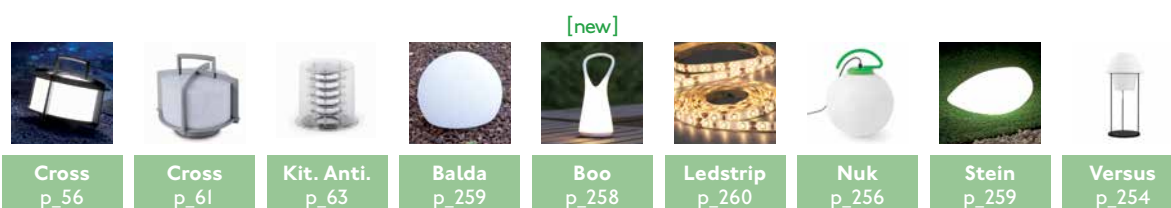

POLE LAMPS

FAROLAS
LAMPADAIRES
LAMPIONI

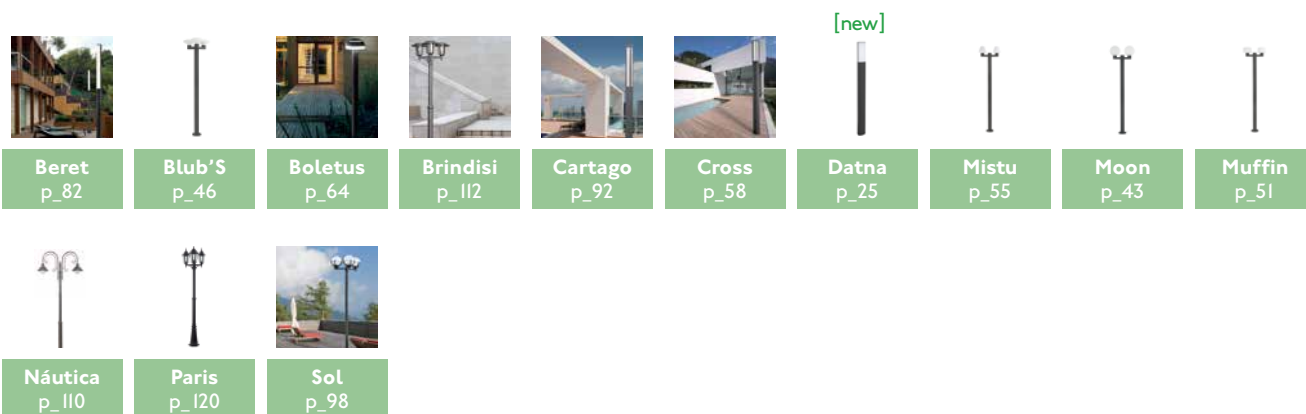

BEACONS

BALIZAS
BALISES
LAMPIONI BASSI



	[new] 				[new] 	[new] 			
Muffin p_49	Naya p_125	Neo p_85	Onze p_96	Palm p_97	Rounder p_79	Saga p_77	Sentinel p_35	Sete p_130	Sol p_99
				[new] 					
Sora p_131	Steps p_31	Surat p_131	Tarraco p_95	Tau p_21	Trial p_67	Verno p_133	Wilma p_89	Yak p_33	

TABLE LAMPS

SOBREMESA
LAMPES DE TABLE
DA TAVOLO



Versus
p_254



Alp
p_69



Amon
p_143



Aton
p_236



Baco
p_161



Balder
p_247



Bastet
p_213



Boo
p_258



Cabo
p_179



Chandra
p_126



Cobo
p_150



Ele
p_142



Ellen
p_81



Giza
p_75



Grant
p_165



Horus
p_205



Inari
p_160



Kami
p_154



Naomi
p_161



Naya
p_125



Neftis
p_155



Nisha
p_161



Noray
p_179



Radha
p_145



Rounder
p_79



Saga
p_77



Sedna
p_203



Seth
p_247



Sobek
p_246



Suria
p_223



Taro
p_223



Tau
p_21



Tinia
p_153



View
p_136



Visnu
p_181



NEW

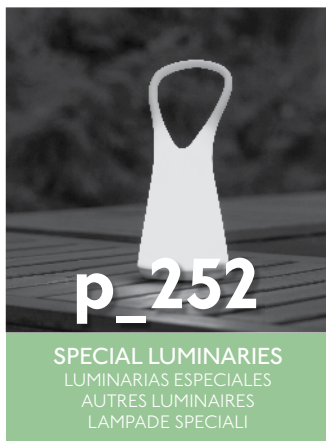
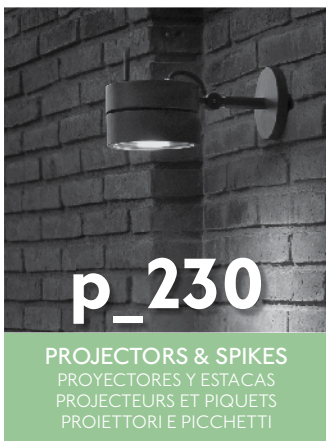
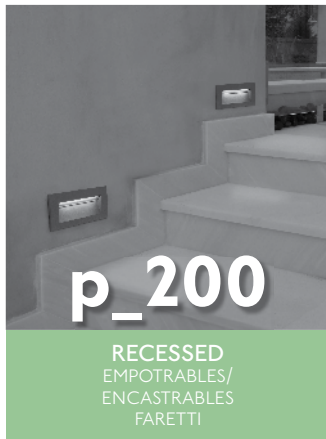
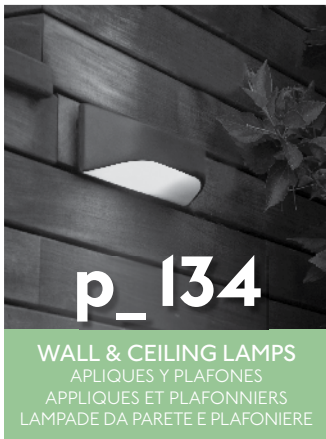



Outdoor luminaires are produced by processes and materials that give them high resistance to adverse environmental conditions and contribute to energy saving.







































Nuestra selección de luminarias producidas con materiales y mediante procesos que les confieren una alta resistencia ante las condiciones ambientales, a la vez que contribuyen con el ahorro energético.

Luminaires d'extérieur fabriqués avec des matériaux et des procédés qui leur confèrent une haute résistance aux conditions environnementales adverses et qui contribuent à réaliser des économies d'énergie.

La nostra collezione di illuminazione da esterni sono tutte prodotte con materiali e mediante processi che conferiscono una alta resistenza alle condizioni ambientali, e allo stesso momento contribuiscono al risparmio energetico.

series

series/séries/series

 aLP [new]	68	 náuTica	106
 beRet	82	 nEo	84
 biRd	26	 nEwport	38
 blUb's	44	 onZe	96
 boleTus	64	 pAlm	97
 briNdisi	112	 pAris	118
 caRtago	92	 rounDer [new]	78
 cRoss	56	 sAga [new]	76
 dAs	70	 sAil	100
 datNa	22	 senTinel	34
 ellEn	80	 sOl	98
 esToril	104	 sTeps	28
 giNa [new]	72	 tarrAco	94
 giZa [new]	74	 tAu [new]	20
 klaMp	36	 teRuel	116
 lOng	90	 tOledo	114
 misTu	52	 triAl	66
 mitRa	102	 wilMa	86
 mOon	40	 yAk	32
 mUffin	48		



SERIES



tAu [new]

by Manel Llusçà

An outdoor collection that is characterized by its sober and architectural lines. Tau presents a compact and solid design, making it a solution for highly aesthetic outdoor lighting.

Colección para exterior que se caracteriza por sus líneas sobrias y arquitectónicas. Tau presenta un diseño compacto y sólido, convirtiéndose en una solución altamente estética.

Collection pour intérieur qui se caractérise par sa ligne sobre et architectural. Tau présente un design compact et solide, se convertissant en une solution hautement esthétique pour l'illumination des extérieurs.



[new] **post lamp**

74446



dark grey
gris oscuro

1 XE27 MAX 20W NOT INCL. [16467] [LED I7059]
DIE CAST ALUMINIUM+OPAL POLYCARBONATE/
ALUMINIO INYECTADO+POLICARBONATO OPAL
A++ to A / 100-240V ~ 50-60 Hz / 0.86 kg/1.90 lb

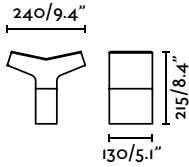

[new] **beacon**

74447



dark grey
gris oscuro

1 XE27 MAX 20W NOT INCL. [16467] [LED I7059]
DIE CAST ALUMINIUM+OPAL POLYCARBONATE/
ALUMINIO INYECTADO+POLICARBONATO OPAL
A++ to A / 100-240V ~ 50-60 Hz / 1.34 kg/2.95 lb

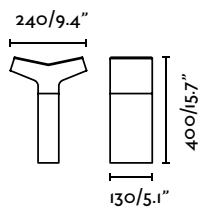

[new] **beacon**

74448



dark grey
gris oscuro

1 XE27 MAX 20W NOT INCL. [16467] [LED I7059]
DIE CAST ALUMINIUM+OPAL POLYCARBONATE/
ALUMINIO INYECTADO+POLICARBONATO OPAL
A++ to A / 100-240V ~ 50-60 Hz / 1.51 kg/3.33 lb

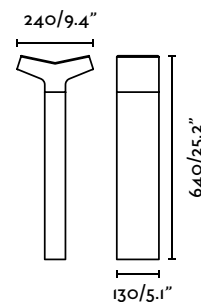

datNa

by Manel Llusçà

Seeking integration with the urban landscape and new architecture, we provide a minimalist design with a single volume.

Buscando integración con el paisaje urbano y la nueva arquitectura, aportamos diseño de línea minimalista y volumen monolítico.

En recherchant l'intégration au paysage urbain et à la nouvelle architecture, nous proposons un design aux lignes épurées et un volume monolithique.

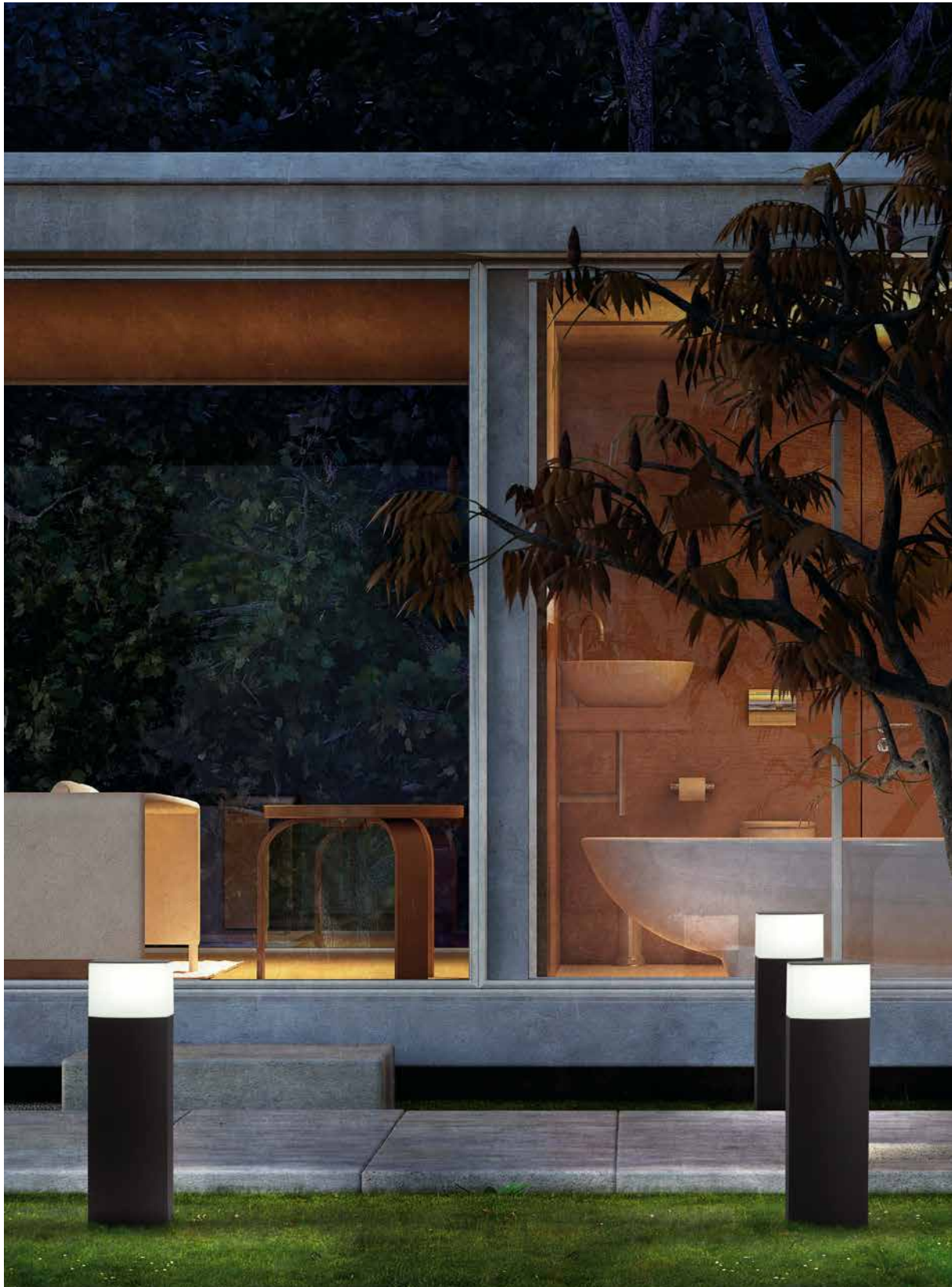

wall lamp

74440



dark grey
gris oscuro

1 X E27 MAX 20W NOT INCL. [16467]

DIE CAST ALUMINIUM+OPAL POLYPROPYLENE/
ALUMINIO INYECTADO+POLIPROPILENO OPAL

A++ to B / 100-240V ~ 50-60 Hz / 1.1 kg/2.43 lb

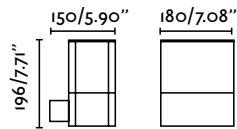

beacon

74442



dark grey
gris oscuro

1 X E27 MAX 20W NOT INCL. [16467]

DIE CAST ALUMINIUM+OPAL POLYPROPYLENE/
ALUMINIO INYECTADO+POLIPROPILENO OPAL

A++ to B / 100-240V ~ 50-60 Hz / 2.4 kg/5.29 lb

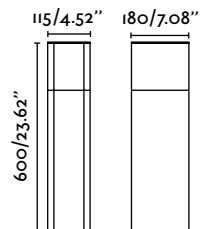

datNa

by Manel Lluscà



beacon

74441



dark grey
gris oscuro

1 X E27 MAX 20W NOT INCL. [16467]

DIE CAST ALUMINIUM+OPAL POLYPROPYLENE
ALUMINIO INYECTADO+POLIPROPILENO OPAL

A++ to B / 100-240V ~ 50-60 Hz / 1.3 kg/2.87 lb

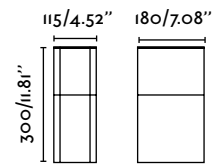

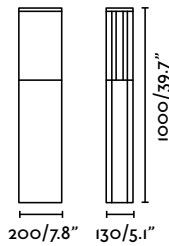

IP65

[new] **beacon**

74443  dark grey
gris oscuro

I XPL 2 G II 36W NOT INCL. [15923] GEAR INCL.
DIE CAST ALUMINIUM+OPAL POLYCARBONATE
ALUMINIO INYECTADO+POLICARBONATO OPAL

A++ to B / 220-240V ~ 50-60 Hz / 2.4 kg/5.29 lb

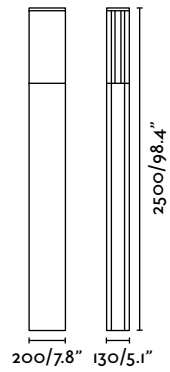

IP65

[new] **pole lamp**

74444  dark grey
gris oscuro

I XPL 2 G II 55W NOT INCL. [15925] GEAR INCL.
DIE CAST ALUMINIUM+OPAL POLYCARBONATE
ALUMINIO INYECTADO+POLICARBONATO OPAL

A++ to B / 220-240V ~ 50-60 Hz / 8.30 kg/18.30 lb



series
series
séries
serie

biRd

by Estudi Ribaudí

Bird is inspired by Japanese origami, a culture that sought permanent harmony in open spaces.

Bird está inspirada en la papiroflexia japonesa, una cultura que buscaba la permanente armonía en sus espacios abiertos.

Bird est inspirée de l'origami japonais, une culture à la recherche d'une harmonie permanente dans ses espaces ouverts.

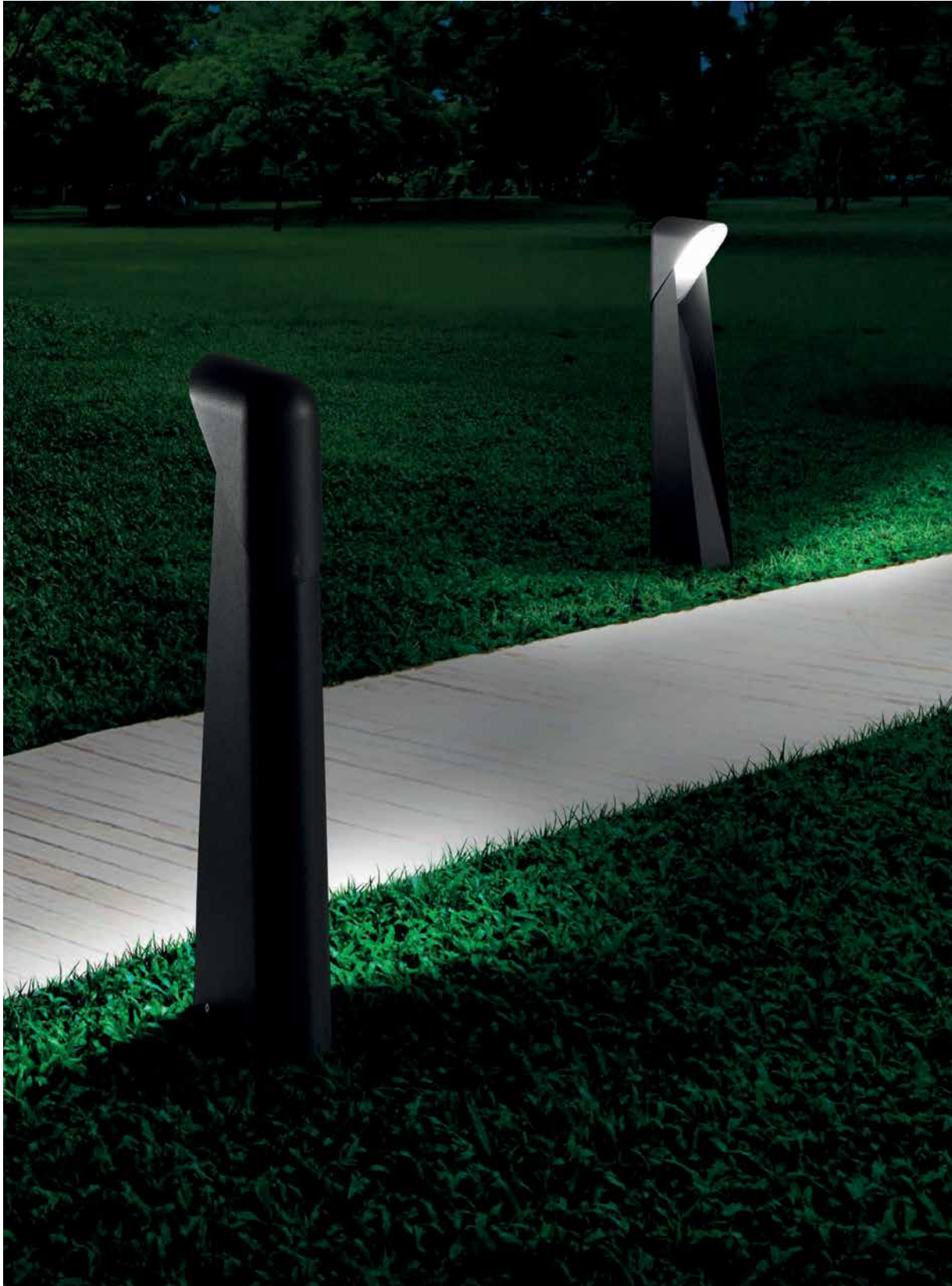

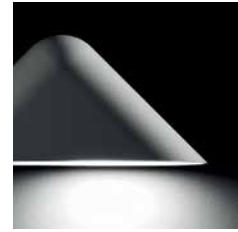

wall lamp

- 75509  white
blanco
- 75510  grey
gris
- 75511  black
negro



1XE27 MAX 20W NOT INCL. [16466]

DIE CAST ALUMINIUM+TRANSLUCID POLYCARBONATE/
ALUMINIO INYECTADO+POLICARBONATO TRANSLÚCIDO

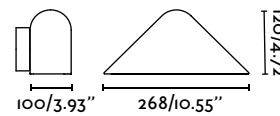
A++ to B / 100-240V ~ 50-60 Hz / 0.7 kg/1.54 lb



beacon

- 75512  black
negro
- 75513  black
negro

1XE27 MAX 20W NOT INCL. [16466]

DIE CAST ALUMINIUM+TRANSLUCID POLYCARBONATE/
ALUMINIO INYECTADO+POLICARBONATO TRANSLÚCIDO

A++ to B / 100-240V ~ 50-60 Hz / 1.7 kg/3.75 lb

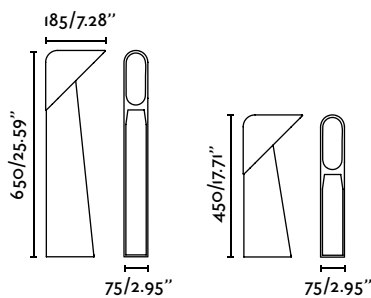

Ref. 75513

Ref. 75512



sSteps

by Estudi Ribaudí

Steps is a tubular composition that gives a growing sensation in the space. A set of upper and lower lights accentuates this feeling.

Steps es una composición tubular que provoca una sensación creciente en el espacio. Su juego de luces superior e inferior acentúa esta sensación.

Steps est une composition tubulaire qui crée une impression d'agrandissement de l'espace. Son jeu de lumières vers le haut et le bas accentue cette impression.



wall lamp

75500  white
blanco

75501  dark grey
gris oscuro

2XGU 10 MAX 35W NOT INCL. [I4030] [LED I4141]

DIE CAST ALUMINIUM+TEMPERED GLASS/
ALUMINIO INYECTADO+CRISTAL TEMPLADO

A++ to E / 100-240V ~ 50-60 Hz / 0.9 kg/1.98 lb

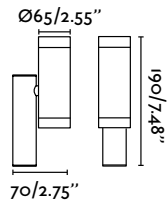

wall lamp

75502  white
blanco

75503  dark grey
gris oscuro

4XGU 10 MAX 35W NOT INCL. [I4030] [LED I4141]

DIE CAST ALUMINIUM+TEMPERED GLASS/
ALUMINIO INYECTADO+CRISTAL TEMPLADO

A++ to E / 100-240V ~ 50-60 Hz / 1.4 kg/3.09 lb

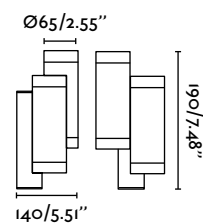

sSteps

by Estudi Ribaudí

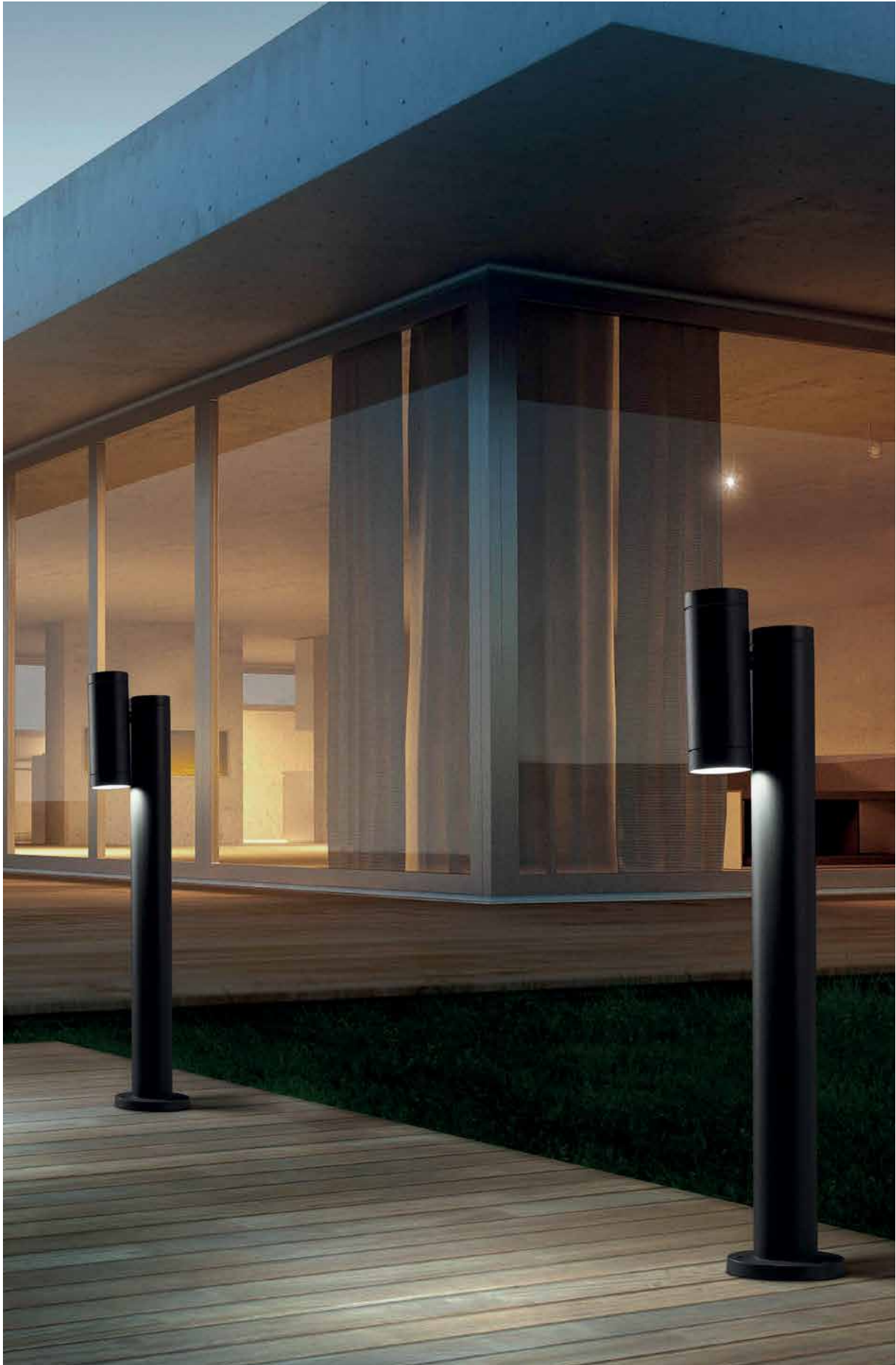

beacon

75504  white
blanco

75505  dark grey
gris oscuro

1 XGU 10 MAX 35W NOT INCL. [14030] [LED 14141]

DIE CAST ALUMINIUM+TEMPERED GLASS/
ALUMINIO INYECTADO+CRISTAL TEMPLADO

A++ to E / 100-240V ~ 50-60 Hz / 2.3 kg/5.07 lb

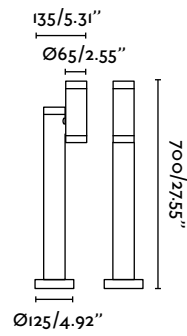

beacon

75506  white
blanco

75507  dark grey
gris oscuro

2 XGU 10 MAX 35W NOT INCL. [14030] [LED 14141]

DIE CAST ALUMINIUM+TEMPERED GLASS/
ALUMINIO INYECTADO+CRISTAL TEMPLADO

A++ to E / 100-240V ~ 50-60 Hz / 2.3 kg/5.07 lb

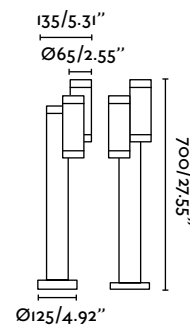

yAk

by Manel Llusçà

Minimising space and achieving new unconventional shapes through the use of LED technology.

Minimizar el espacio y conseguir nuevas formas no convencionales gracias al uso de la tecnología LED.

Minimiser l'espace occupé et obtenir de nouvelles formes non conventionnelles grâce à l'utilisation de la technologie LED.

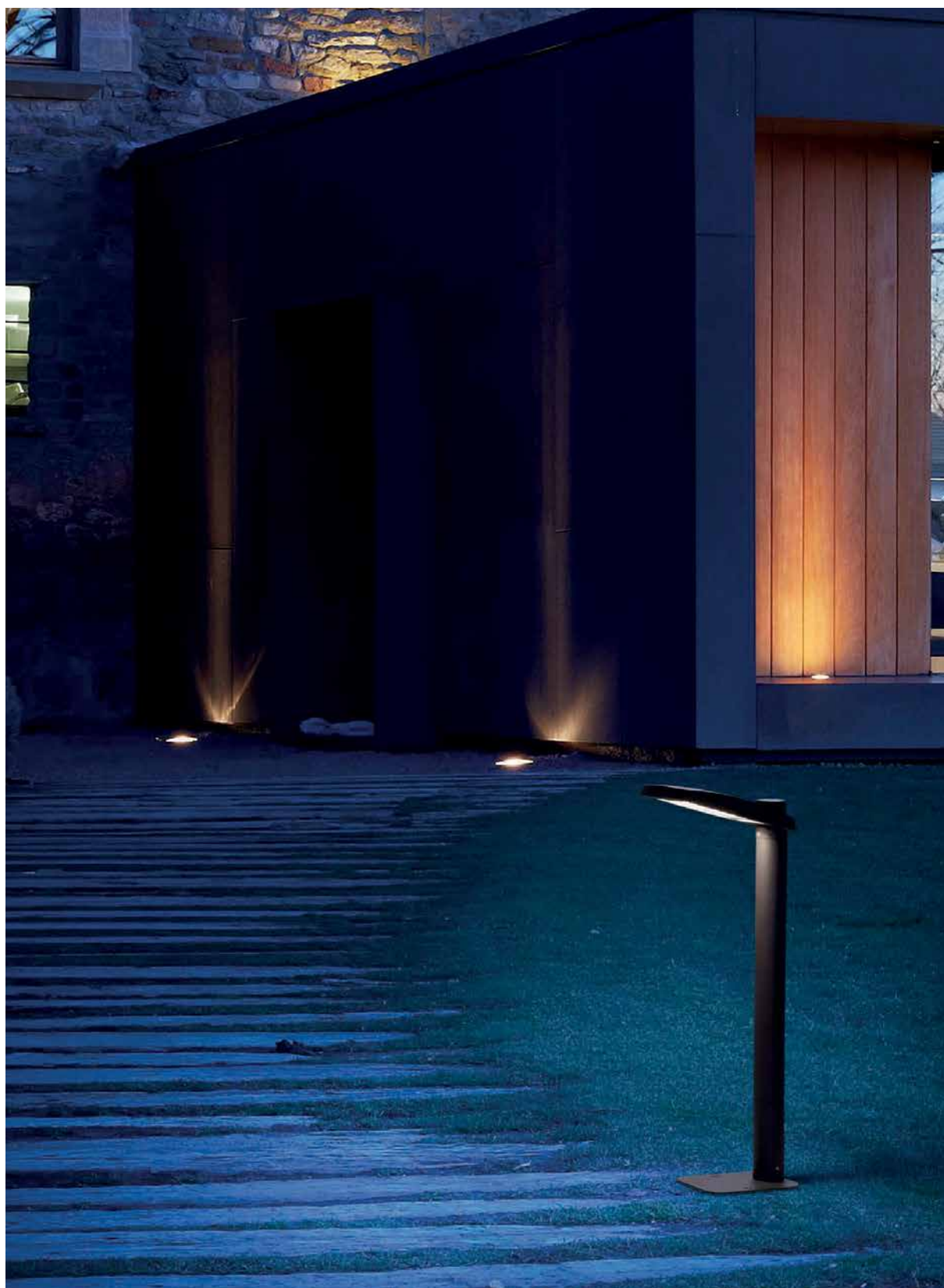

wall lamp

75105  white
blanco

75106  dark grey
gris oscuro

SMD LED 6W 4000K 630LM INCL. DRIVER INCL.
DIE CAST ALUMINIUM+TRANSPARENT GLASS/
ALUMINIO INYECTADO+CRISTAL TRANSPARENTE

A++ / 220-240V ~ 50 Hz / 1.2 kg/2.65 lb

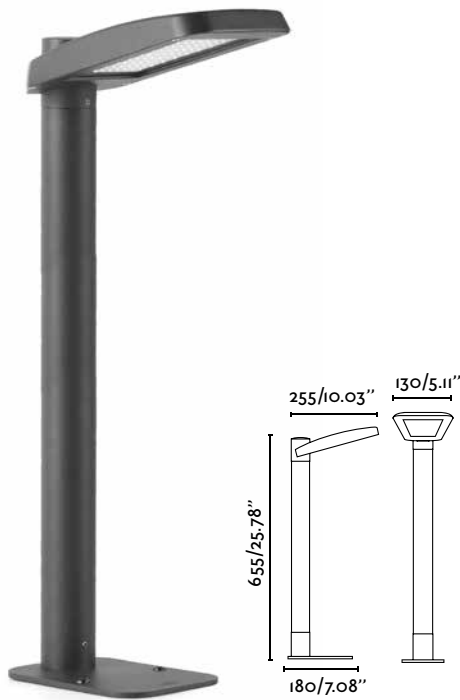
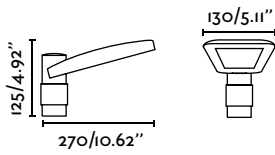

beacon

75110  dark grey
gris oscuro

SMD LED 6W 4000K 630LM INCL. DRIVER INCL.
DIE CAST ALUMINIUM+TRANSPARENT GLASS/
ALUMINIO INYECTADO+CRISTAL TRANSPARENTE

A++ / 220-240V ~ 50-60 Hz / 1.71 kg/3.77 lb



beacon

75108  dark grey
gris oscuro

SMD LED 6W 4000K 630LM INCL. DRIVER INCL.
DIE CAST ALUMINIUM+TRANSPARENT GLASS/
ALUMINIO INYECTADO+CRISTAL TRANSPARENTE

A++ / 220-240V ~ 50 Hz / 1.8 kg/3.97 lb



senTinel

by Estudi Ribaudí

Sentinel comes from the synthesis of form, the result provides us with a collection of soft shapes with real personality.

Sentinel nace de un ejercicio de síntesis de la forma, que como resultado nos ofrece una colección de formas suaves y de marcadas personalidad.

Sentinel est le fruit d'un exercice de synthèse de la forme, un ensemble de formes douces avec une forte personnalité.

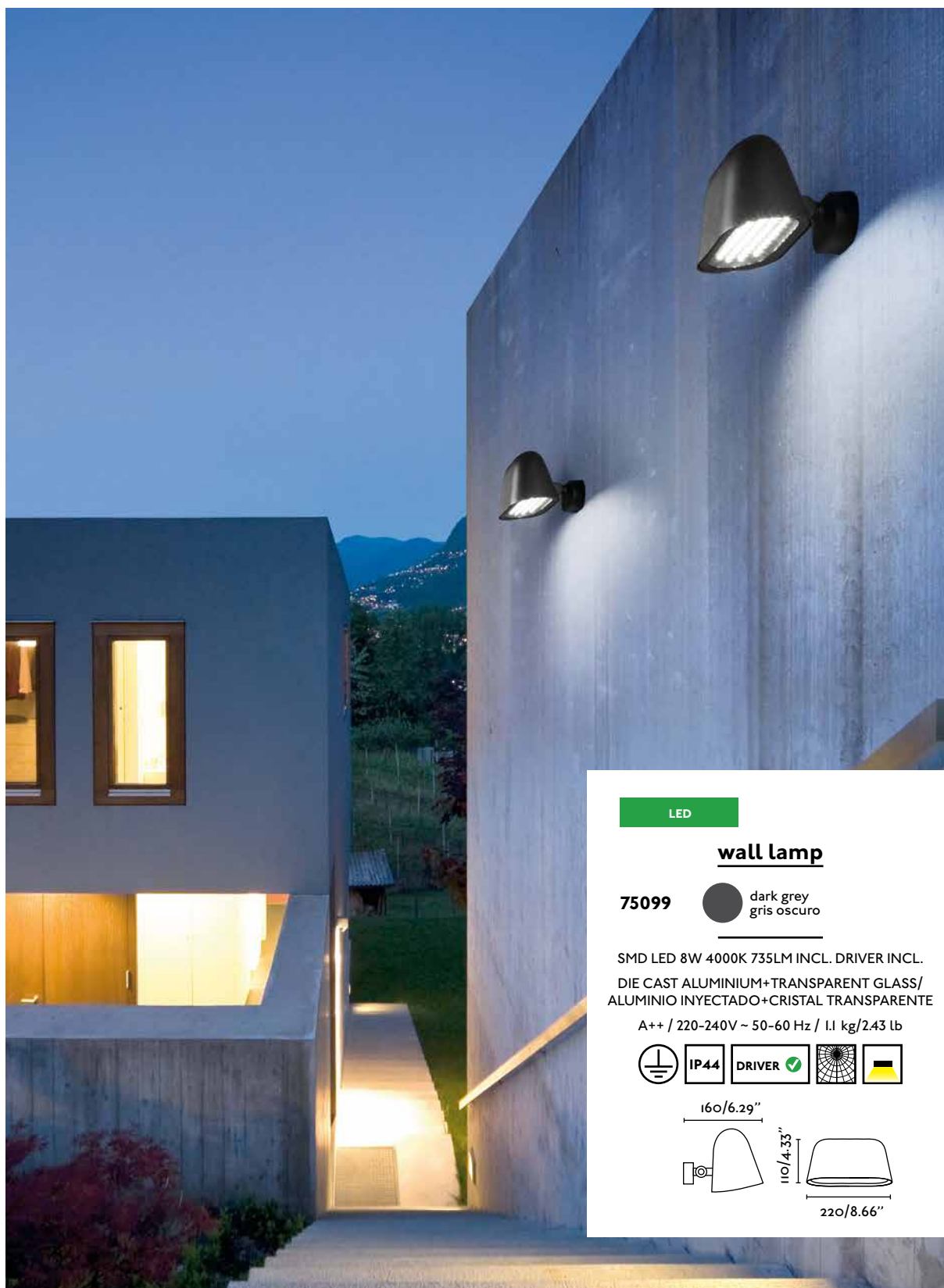

LED

wall lamp

75099

dark grey
gris oscuro

SMD LED 8W 4000K 735LM INCL. DRIVER INCL.
DIE CAST ALUMINIUM+TRANSPARENT GLASS/
ALUMINIO INYECTADO+CRISTAL TRANSPARENTE
A++ / 220-240V ~ 50-60 Hz / 1.1 kg/2.43 lb



IP44

DRIVER

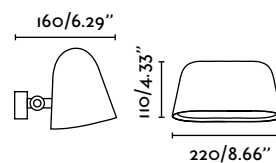



wall lamp

75100  white
blanco

75101  dark grey
gris oscuro

I XE27 MAX 20W NOT INCL. [16467]

DIE CAST ALUMINIUM+TRANSPARENT GLASS/
ALUMINIO INYECTADO+CRISTAL TRANSPARENTE

A++ to B / 100-240V ~ 50-60 Hz / 1.1 kg/2.20 lb

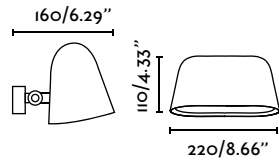

beacon

75102  white
blanco

75103  dark grey
gris oscuro

I XE27 MAX 20W NOT INCL. [16467]

DIE CAST ALUMINIUM+TRANSPARENT GLASS/
ALUMINIO INYECTADO+CRISTAL TRANSPARENTE

A++ to B / 100-240V ~ 50-60 Hz / 2.64 kg/5.82 lb

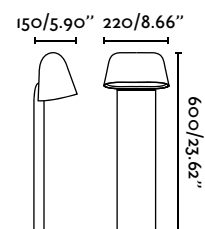

klaMp

by Manel Llusçà

A esthetics and functionality come together in this series of contemporary and stylish lines. The beacons are available with a light sensor to provide the user with maximum comfort and safety.

Estética y funcionalidad se dan la mano en esta serie de líneas contemporáneas y estilizadas. Las balizas están disponibles con sensor de luz para ofrecer mayor comodidad y seguridad al usuario.

Esthétique et fonctionnalité sont réunies dans cette série aux lignes contemporaines et épurées. Les balises sont disponibles avec un capteur de lumière pour offrir un maximum de confort et de sécurité à l'utilisateur.

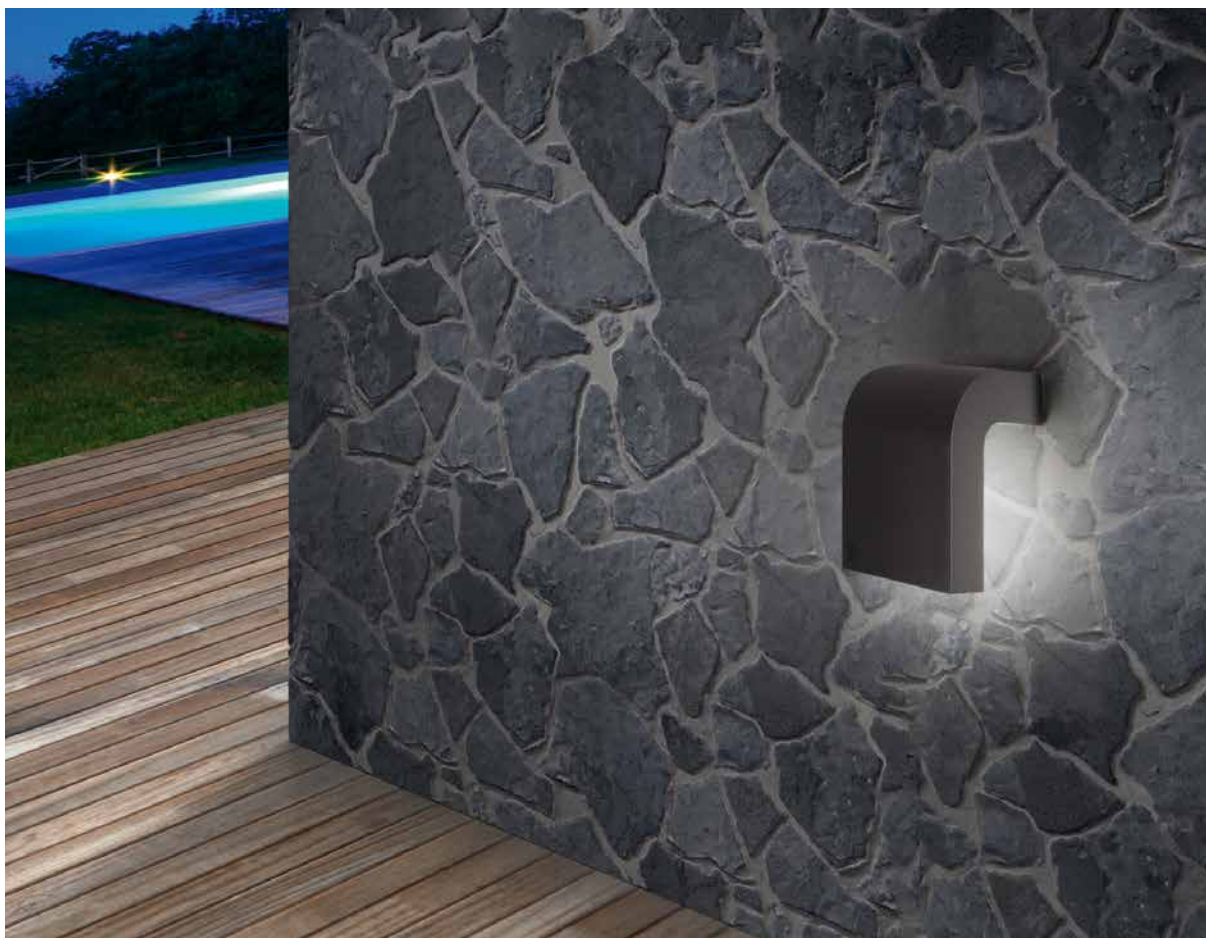

wall lamp

74409

dark grey
gris oscuro

1XE27 MAX 15W NOT INCL. [16466]

DIE CAST ALUMINIUM+OPAL POLYCARBONATE/
ALUMINIO INYECTADO+POLICARBONATO OPAL

A++ to B / 100-240V ~ 50-60 Hz / 1.1 kg/2.43 lb

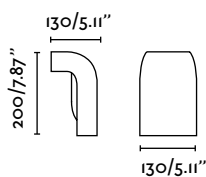

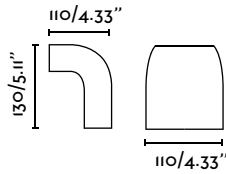

wall lamp

74407 ● dark grey / gris oscuro

1 XGU10 MAX 35W NOT INCL. [14030] [LED 14141]
 DIE CAST ALUMINIUM+TRANSPARENT GLASS/
 ALUMINIO INYECTADO+CRISTAL TRANSPARENTE

A++ to E / 100-240V ~ 50-60 Hz / 0.65 kg/1.43 lb

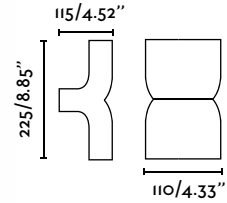

wall lamp

74408 ● dark grey / gris oscuro

2 XGU10 MAX 35W NOT INCL. [14030] [LED 14141]
 DIE CAST ALUMINIUM+TRANSPARENT GLASS/
 ALUMINIO INYECTADO+CRISTAL TRANSPARENTE

A++ to B / 100-240V ~ 50-60 Hz / 0.97 kg/2.14 lb

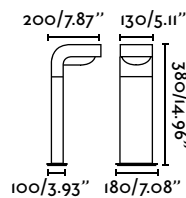

beacon

74410 ● dark grey / gris oscuro

1 XE27 15W NOT INCL. [16466]
 DIE CAST ALUMINIUM+OPAL POLYCARBONATE/
 ALUMINIO INYECTADO+POLICARBONATO OPAL

A++ to B / 100-240V ~ 50-60 Hz / 2.1-2.84 kg/4.63-6.26 lb

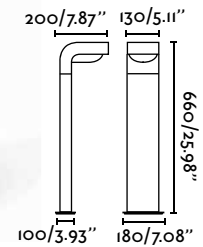

beacon

74411 ● dark grey / gris oscuro

1 XE27 15W NOT INCL. [16466]
 DIE CAST ALUMINIUM+OPAL POLYCARBONATE/
 ALUMINIO INYECTADO+POLICARBONATO OPAL

A++ to B / 100-240V ~ 50-60 Hz / 2.1-2.84 kg/4.63-6.26 lb

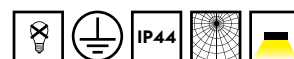

nEwport

by Estudi Ribaudí

Newport is a lamp that evokes a return to authentic and intimate objects. It transports us to the romanticism of the beginning of the century ... A timeless appearance.

Newport es una lámpara que se inspira en el retorno a los objetos auténticos y entrañables. Nos transporta al romanticismo de principios de siglo... A una estética atemporal.

Newport est un luminaire inspiré du retour aux objets authentiques et émouvants. Il nous ramène au romantisme du début du siècle... À une esthétique intemporelle.

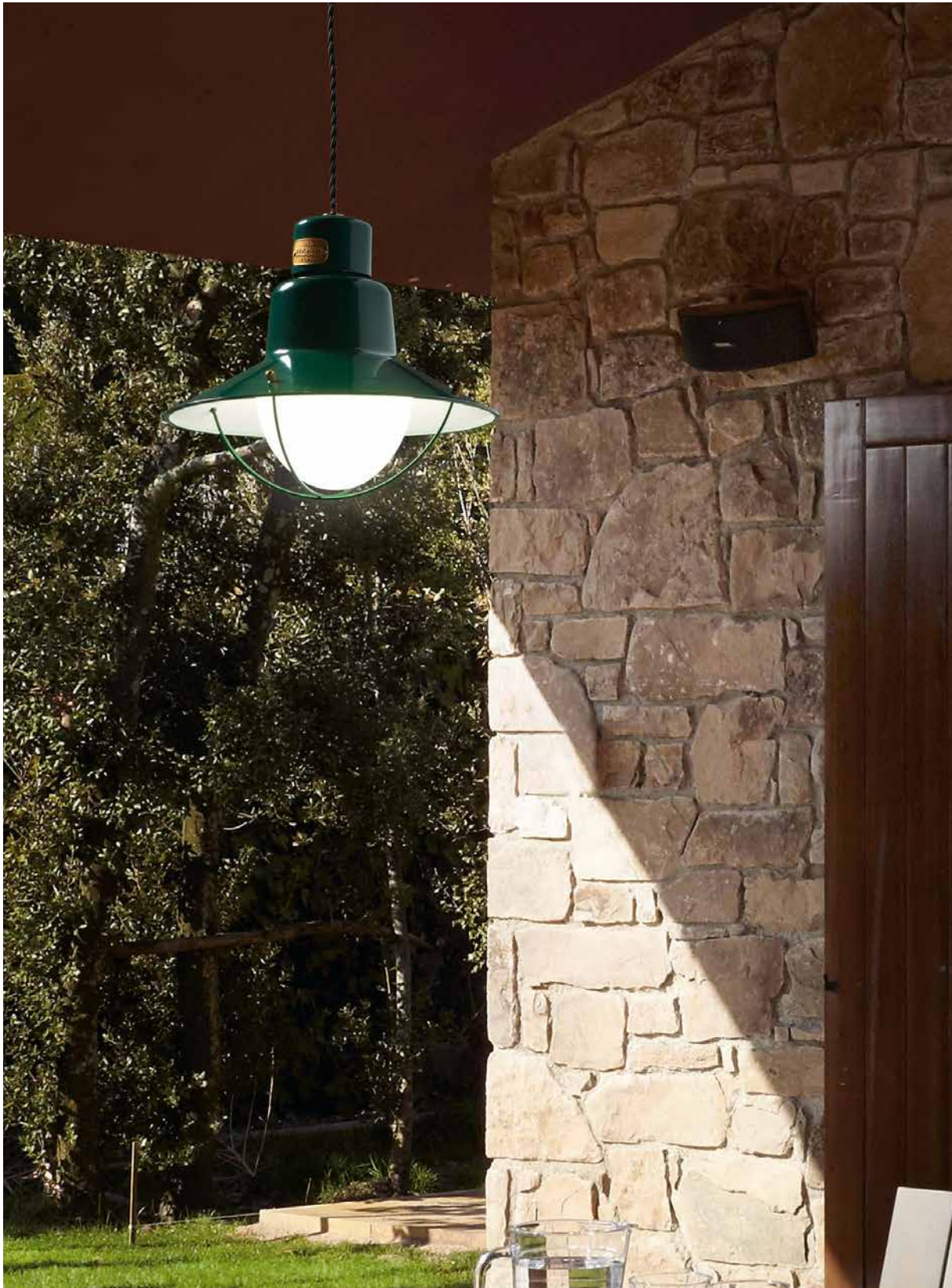



wall lamp

- 71151  white
blanco
- 71152  green
verde
- 71153  bordeaux
burdeos

1 X E27 MAX 60W NOT INCL. [16466] [LED 17059]

METAL+OPAL GLASS/
METAL+CRISTAL OPAL

A++ to E / 100-240V ~ 50-60 Hz / 1.8 kg/3.97 lb

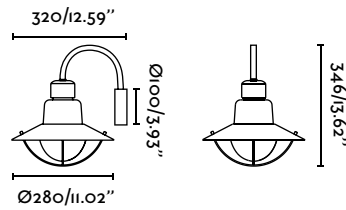

pendant lamp

- 71154  white
blanco
- 71155  green
verde
- 71156  bordeaux
burdeos

1 X E27 MAX 60W NOT INCL. [16466] [LED 17059]

METAL+OPAL GLASS/
METAL+CRISTAL OPAL

A++ to E / 100-240V ~ 50-60 Hz / 1.7 kg/3.75 lb

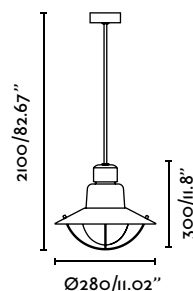

mOon

by Faro Team

It is the search for the essence of light, and simplicity in shape. A full moon that floods everything around it with light.

Es la búsqueda de la esencia de la luz, la simplicidad en la forma. Un plenilunio que inunda de luz todo a su alrededor.

La recherche de l'essence de la lumière et de la simplicité de la forme. Une pleine lune qui inonde de lumière tout ce qui l'entoure.



wall lamp

74432+74437

dark grey
gris oscuro

1XE27 20W NOT INCL. [16467]

DIE CAST ALUMINIUM+ OPAL PMMA/
ALUMINIO INYECTADO+PMMA OPAL

A++ to B / 100-240V ~ 50-60 Hz / 0.6 kg/1.32 lb

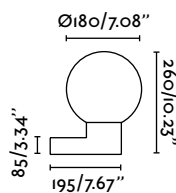



post lamp

74433+74437 ● dark grey / gris oscuro

74433+74438 ● dark grey / gris oscuro

1 XE27 20W NOT INCL. [16467]

DIE CAST ALUMINIUM+ OPAL PMMA/
ALUMINIO INYECTADO+PMMA OPAL

A++ to B / 100-240V ~ 50-60 Hz / 0.6 kg/1.32 lb

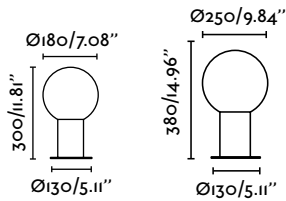

Ref. 74433+74437 Ref. 74433+74438



beacon

74434+74437 ● dark grey / gris oscuro

74434+74438 ● dark grey / gris oscuro

1 XE27 20W NOT INCL. [16467]

DIE CAST ALUMINIUM+ OPAL PMMA/
ALUMINIO INYECTADO+PMMA OPAL

A++ to B / 100-240V ~ 50-60 Hz / 1.3 kg/2.87 lb

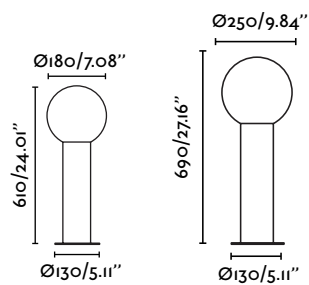

Ref. 74434+74437 Ref. 74434+74438

mOon
by Faro Team



pendant

74427+74437 ● dark grey
gris oscuro

74427+74438 ● dark grey
gris oscuro

1 XE27 MAX 20W NOT INCL. [16467]

DIE CAST ALUMINIUM+ OPAL PMMA/
ALUMINIO INYECTADO+PMMA OPAL

A++ to B / 100-240V ~ 50-60 Hz / 0.56 kg/1.30 lb

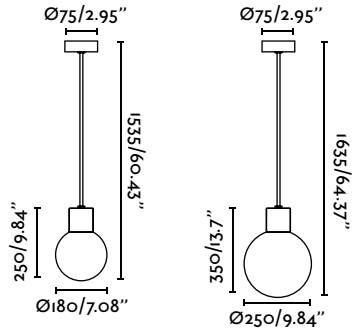

Ref. 74427+74437

Ref. 74427+74438



pole lamp

74435+74438 ● dark grey
gris oscuro
(1 ud.) (2 ud.)

2XE27 MAX 20W NOT INCL. [16467]

74436+74438 ● dark grey
gris oscuro
(1 ud.) (3 ud.)

3XE27 MAX 20W NOT INCL. [16467]

DIE CAST ALUMINIUM+ OPAL PMMA/
ALUMINIO INYECTADO+PMMA OPAL

A++ to B / 100-240V ~ 50-60 Hz / 7 kg/15.43 lb

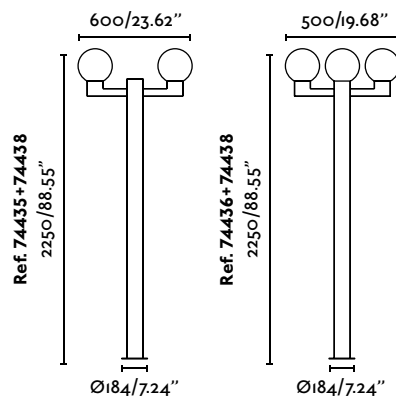

blUb's

by Estudi Ribaudí

Blub's is like a bubble of air emanating from the earth. Its shapes are softened by the light and complement the space in a simple and ordered way.

Blub's es como una burbuja de aire que emana de la tierra; sus formas se difuminan con la luz y complementan el espacio de una forma simple y ordenada.

Blub's est comme une bulle d'air qui émane de la terre; ses formes s'estompent avec la lumière et complètent l'espace de manière simple et ordonnée.



wall lamp

74432+74430

dark grey
gris oscuro

1XE27 20W NOT INCL. [16467]

DIE CAST ALUMINIUM+ OPAL PMMA/
ALUMINIO INYECTADO+PMMA OPAL

A++ to B / 100-240V ~ 50-60 Hz / 0.6 kg/1.32 lb

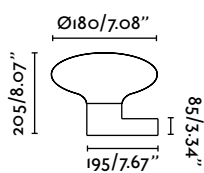



post lamp

74433+74430

● dark grey
gris oscuro

1 XE27 20W NOT INCL. [16467]

DIE CAST ALUMINIUM+ OPAL PMMA/
ALUMINIO INYECTADO+PMMA OPAL

A++ to B / 100-240V ~ 50-60 Hz / 0.80 kg/1.76 lb

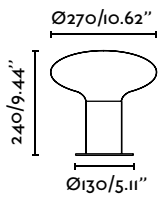

beacon

74434+74430

● dark grey
gris oscuro

1 XE27 20W NOT INCL. [16467]

DIE CAST ALUMINIUM+ OPAL PMMA/
ALUMINIO INYECTADO+PMMA OPAL

A++ to B / 100-240V ~ 50-60 Hz / 1.20 kg/2.64 lb

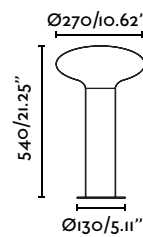

blUb's

by Estudi Ribaudí



pole lamp

74435+74430
(1 ud.) (2 ud.)

● dark grey
gris oscuro

2XE27 MAX 20W NOT INCL. [I6467]

DIE CAST ALUMINIUM+ OPAL PMMA/
ALUMINIO INYECTADO+PMMA OPAL

A++ to B / 100-240V ~ 50-60 Hz / 8.3 kg/18.30 lb

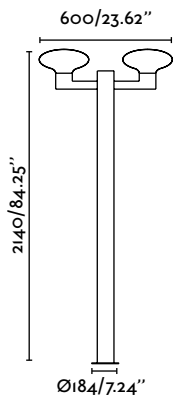

pendant

74427+74430

dark grey
gris oscuro

1XE27 MAX 20W NOT INCL. [I6467]

DIE CAST ALUMINIUM+ OPAL PMMA/
ALUMINIO INYECTADO+PMMA OPAL

A++ to B / 100-240V ~ 50-60 Hz / 0.59 kg/1.30 lb

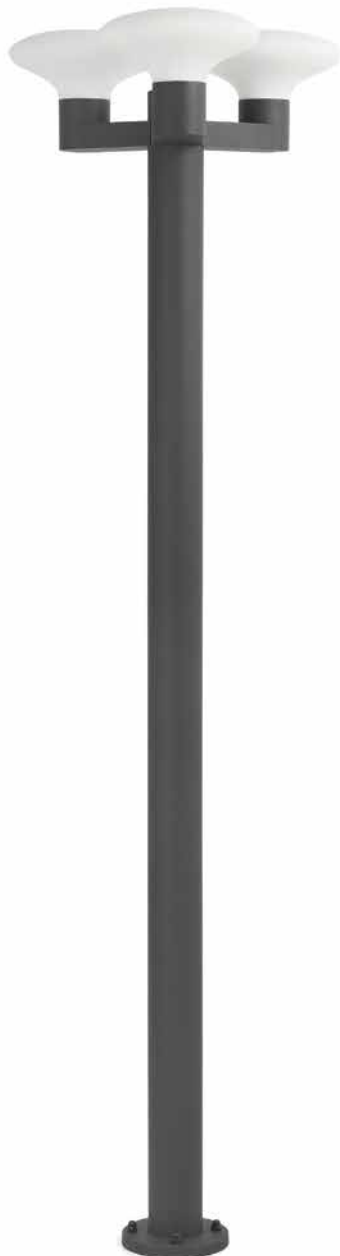
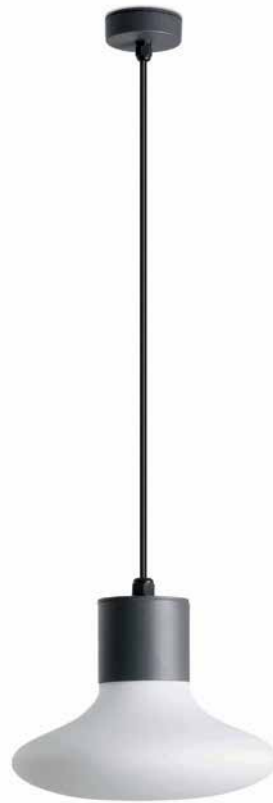
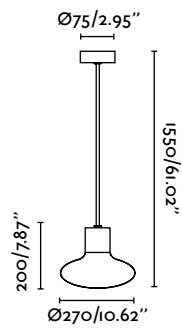

pole lamp

74436+74430
(1 ud.) (3 ud.)

dark grey
gris oscuro

3XE27 MAX 20W NOT INCL. [I6467]

DIE CAST ALUMINIUM+ OPAL PMMA/
ALUMINIO INYECTADO+PMMA OPAL

A++ to B / 100-240V ~ 50-60 Hz / 8.3 kg/18.30 lb



mUffin

by Manel Llusçà

A series with a fun and informal die cast aluminium design with a pleated white opal pmma shade.

Una serie de diseño divertido e informal realizada en aluminio inyectado y pantalla blanca plisada de pmma opal.

Une série au design ludique et informel en fonte d'aluminium avec abat-jour blanc plissé en pmma opaque.



wall lamp

74432+74429



dark grey
gris oscuro

I XE27 MAX 20W NOT INCL. [16467]

DIE CAST ALUMINIUM+ OPAL PMMA/
ALUMINIO INYECTADO+PMMA OPAL

A++ to B / 100-240V ~ 50-60 Hz / 0.6 kg/1.32 lb

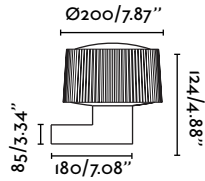

post lamp

74433+74429



dark grey
gris oscuro

I XE27 MAX 20W NOT INCL. [16467]

DIE CAST ALUMINIUM+ OPAL PMMA/
ALUMINIO INYECTADO+PMMA OPAL

A++ to B / 100-240V ~ 50-60 Hz / 0.6 kg/1.32 lb

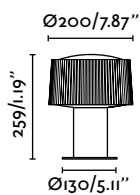

beacon

74434+74429



dark grey
gris oscuro

I XE27 MAX 20W NOT INCL. [16467]

DIE CAST ALUMINIUM+ OPAL PMMA/
ALUMINIO INYECTADO+PMMA OPAL

A++ to B / 100-240V ~ 50-60 Hz / 1.3 kg/2.87 lb

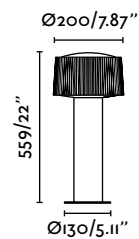

mUffin

by Manel Llusçà



pendant

74427+74429

● dark grey
gris oscuro

1XE27 MAX 20W NOT INCL. [16467]

DIE CAST ALUMINIUM+ OPAL PMMA/
ALUMINIO INYECTADO+PMMA OPAL

A++ to B / 100-240V ~ 50-60 Hz / 1.3 kg/2.87 lb



Ø75/2.95"

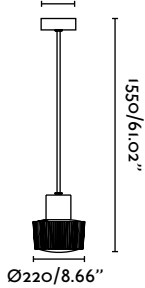

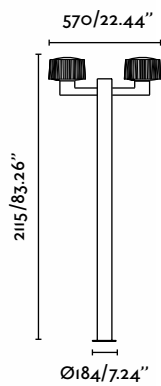

pole lamp

74435+74429
(1 ud.) (2 ud.)

● dark grey
gris oscuro

2XE27 MAX 20W NOT INCL. [16467]

DIE CAST ALUMINIUM+ OPAL PMMA/
ALUMINIO INYECTADO+PMMA OPAL

A++ to B / 100-240V ~ 50-60 Hz / 8.3 kg/18.30 lb

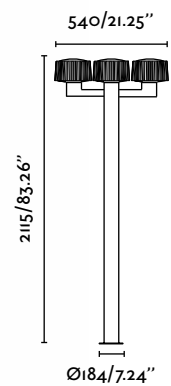

pole lamp

74436+74429
(1 ud.) (3 ud.)

● dark grey
gris oscuro

3XE27 MAX 20W NOT INCL. [16467]

DIE CAST ALUMINIUM+ OPAL PMMA/
ALUMINIO INYECTADO+PMMA OPAL

A++ to B / 100-240V ~ 50-60 Hz / 8.3 kg/18.30 lb



misTu

by Faro Team

Pleasant design for a highly versatile series. A polymethacrylate (pmma) diffuser provides excellent, perfectly proportioned light.

Simpático diseño para una serie de gran versatilidad. Un difusor de polimetacrilato (pmma) procura una excelente luz, perfectamente tamizada.

Un design agréable pour une série très polyvalente. Un diffuseur en polyméthacrylate de méthyle (pmma) procure une lumière exquise, parfaitement tamisée.



wall lamp

74432+74428

dark grey
gris oscuro

1 XE27 20W NOT INCL. [16467]

DIE CAST ALUMINIUM+ OPAL PMMA/
ALUMINIO INYECTADO+PMMA OPAL

A++ to B / 100-240V ~ 50-60 Hz / 0.6 kg/1.32 lb

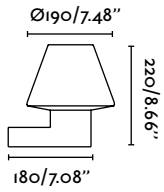

post lamp

74433+74428

dark grey
gris oscuro

1 XE27 20W NOT INCL. [16467]

DIE CAST ALUMINIUM+ OPAL PMMA/
ALUMINIO INYECTADO+PMMA OPAL

A++ to B / 100-240V ~ 50-60 Hz / 0.56 kg/1.30 lb



beacon

74434+74428

dark grey
gris oscuro

1 XE27 20W NOT INCL. [16467]

DIE CAST ALUMINIUM+ OPAL PMMA/
ALUMINIO INYECTADO+PMMA OPAL

A++ to B / 100-240V ~ 50-60 Hz / 0.6 kg/1.32 lb

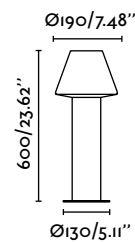

misTu

by Faro Team



pendant

74427+74428



dark grey
gris oscuro

1XE27 MAX 20W NOT INCL. [16467]

DIE CAST ALUMINIUM+ OPAL PMMA/
ALUMINIO INYECTADO+PMMA OPAL

A++ to B / 100-240V ~ 50-60 Hz / 0.6 kg/1.32 lb

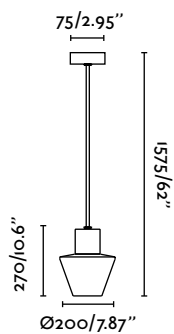

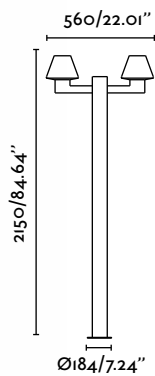

pole lamp

74435+74428
(1 ud.) (2 ud.)

● dark grey
gris oscuro

2XE27 20W NOT INCL. [16467]

DIE CAST ALUMINIUM+ OPAL PMMA/
ALUMINIO INYECTADO+PMMA OPAL

A++ to B / 100-240V ~ 50-60 Hz / 8.3 kg/18.30 lb

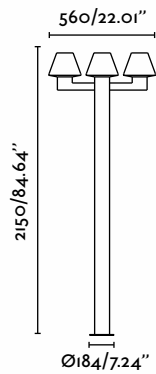

pole lamp

74436+74428
(1 ud.) (3 ud.)

● dark grey
gris oscuro

3XE27 20W NOT INCL. [16467]

DIE CAST ALUMINIUM+ OPAL PMMA/
ALUMINIO INYECTADO+PMMA OPAL

A++ to B / 100-240V ~ 50-60 Hz / 8.3 kg/18.30 lb



cCross

by Manel Llusçà

Made of die cast aluminium and polycarbonate, the cross series is ideal for both contemporary and classic environments.

Realizada en aluminio inyectado y policarbonato, la serie cross es ideal tanto para ambientes actuales como clásicos.

Fabriquée en fonte d'aluminium et en polycarbonate, la série cross est idéale tant dans les espaces modernes que dans les environnements classiques.



IP65

portable

74353

dark grey
gris oscuro

1 X E27 MAX 20W NOT INCL. [I6467] [LED I7059]

DIE CAST ALUMINIUM+OPAL POLYCARBONATE/
ALUMINIO INYECTADO+POLICARBONATO OPAL

A++ to E / 100-240V ~ 50-60 Hz / 0.57 kg/1.26 lb

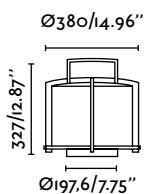

ceiling lamp

74355



dark grey
gris oscuro

2XE27 MAX 20W NOT INCL. [16467] [LED I7059]
DIE CAST ALUMINIUM+OPAL POLYCARBONATE/
ALUMINIO INYECTADO+POLICARBONATO OPAL
A++ to B / 100-240V ~ 50-60 Hz / 2.2 kg/4.85 lb

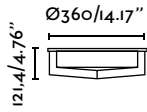

IP65

wall lamp

74350



dark grey
gris oscuro

1XE27 MAX 20W NOT INCL. [16467] [LED I7059]
DIE CAST ALUMINIUM+OPAL POLYCARBONATE/
ALUMINIO INYECTADO+POLICARBONATO OPAL
A++ to E / 100-240V ~ 50-60 Hz / 1.8 kg/4.85/6.83 lb

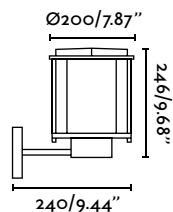

IP65

post lamp

74351



dark grey
gris oscuro

1XE27 MAX 20W NOT INCL. [16467] [LED I7059]
DIE CAST ALUMINIUM+OPAL POLYCARBONATE/
ALUMINIO INYECTADO+POLICARBONATO OPAL
A++ to B / 100-240V ~ 50-60 Hz / 1.55 kg/3.42 lb

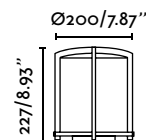

cCross

by Manel Llusçà



IP65

pole lamp

74358

● dark grey
gris oscuro

1 XPL2G II 55W 5000K INCL. GEAR INCL.
DIE CAST ALUMINIUM+OPAL POLYCARBONATE/
ALUMINIO INYECTADO+POLICARBONATO OPAL
A to B / 220-240V ~ 50-60 Hz / 5.97 kg/13.16 lb



IP65

BALLAST

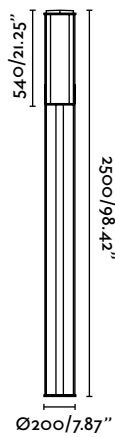

IP65

beacon

74356 ● dark grey / gris oscuro

74357 ● dark grey / gris oscuro

1 X E27 MAX 20W NOT INCL. [16467] [LED I7059]
DIE CAST ALUMINIUM+OPAL POLYCARBONATE/
ALUMINIO INYECTADO+POLICARBONATO OPAL
A++ to E / 100-240V ~ 50-60 Hz / 3-4.6 kg/6.61-10.14 lb

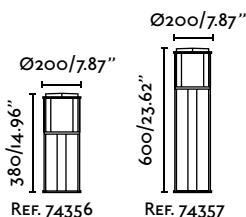

IP65

beacon

74359 ● dark grey / gris oscuro

1 X PL2 G II 36W 6400K INCL. GEAR INCL.
DIE CAST ALUMINIUM+OPAL POLYCARBONATE/
ALUMINIO INYECTADO+POLICARBONATO OPAL
A to B / 220-240V ~ 50-60 Hz / 5.97 kg/13.16 lb



LED IP65

74349 ● dark grey / gris oscuro

LED STRIPS 24W 4000K 2500LM INCL. DRIVER INCL.
DIE CAST ALUMINIUM+OPAL POLYCARBONATE/
ALUMINIO INYECTADO+POLICARBONATO OPAL
A++ to A / 220-240V ~ 50-60 Hz / 4.6 kg/10.14 lb

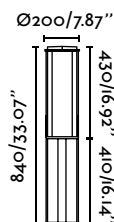

series
series
séries
serie

cCross

by Manel Llusçà



pendant

74364



silver grey
gris plata

HF

1 X E27 MAX 100W NOT INCL. [16467] [LED 17059]

DIE CAST ALUMINIUM+OPAL POLYCARBONATE/
ALUMINIO INYECTADO+POLICARBONATO OPAL

A++ to E / 100-240V ~ 50-60 Hz / 3.19 kg/7.91 lb

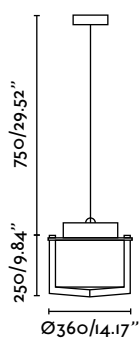

IP65

beacon

74366

silver grey
gris plata

HF

[new] **74371**

brown
marrón

1 XE27 MAX 60W NOT INCL. [16467] [LED I7059]
DIE CAST ALUMINIUM+OPAL POLYCARBONATE/
ALUMINIO INYECTADO+POLICARBONATO OPAL
A++ to E / 100-240V ~ 50-60 Hz / 2.87 kg/6.33 lb

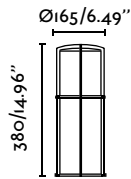

IP65

portable

74363

silver grey
gris plata

HF

1 XE27 MAX 100W NOT INCL. [16467] [LED I7059]
DIE CAST ALUMINIUM+OPAL POLYCARBONATE/
ALUMINIO INYECTADO+POLICARBONATO OPAL
A++ to E / 100-240V ~ 50-60 Hz / 3.79 kg/8.36 lb

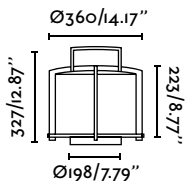

IP65

post lamp

74362

silver grey
gris plata

HF

1 XE27 MAX 100W NOT INCL. [16467] [LED I7059]
DIE CAST ALUMINIUM+OPAL POLYCARBONATE/
ALUMINIO INYECTADO+POLICARBONATO OPAL
A++ to E / 100-240V ~ 50-60 Hz / 3.2 kg/7.05 lb

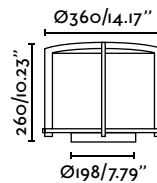

HF Until stock exhaustion
Hasta final de stock
Jusqu'à la fin de stock

series
series
séries
serie

cCross

by Manel Llusçà





antipollution light P

74369



chrome
cromado

FOR / PARA

74350, 73351, 74356, 74357, 74366

STEEL+TRANSPARENT POLYCARBONATE/
ACERO+POLICARBONATO TRANSPARENTE

0.8 kg/1.76 lb



Ø135/5.31"

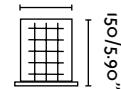

antipollution light G

74370



chrome
cromado

FOR / PARA

74358

STEEL+TRANSPARENT POLYCARBONATE/
ACERO+POLICARBONATO TRANSPARENTE

2.4 kg/5.29 lb



Ø140/5.51"

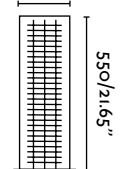

boleTus

by Manel Llusçà

With a modern design and rounded lines, boletus provides indirect and nuanced light thanks to its opal polycarbonate diffuser and the slot in the top of the shade.

Con un diseño moderno y de líneas redondeadas, Boletus proporciona luz indirecta y matizada gracias a su difusor de policarbonato opal y a la ranura superior situada en su pantalla.

Avec son design moderne et ses lignes arrondies, boletus apporte une lumière indirecte et nuancée grâce à son diffuseur en polycarbonate opaque et à l'ouverture située sur le dessus.



pole lamp

74395

dark grey
gris oscuro

3XE27 20W NOT INCL. [16467]

DIE CAST ALUMINIUM+OPAL POLYCARBONATE/
ALUMINIO INYECTADO+POLICARBONATO OPAL

A++ to B / 100-240V ~ 50-60 Hz / 9.5 kg/20.94 lb



Ø322/12.67"

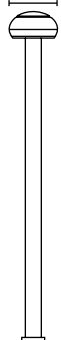

2500/98.42"

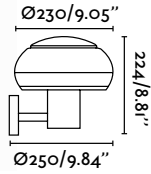

wall lamp

74391

● dark grey
gris oscuro

1XE27 20W NOT INCL. [I6467]

DIE CAST ALUMINIUM+OPAL POLYCARBONATE/
ALUMINIO INYECTADO+POLICARBONATO OPAL

A++ to B / 100-240V ~ 50-60 Hz / 1.6 kg/3.53 lb

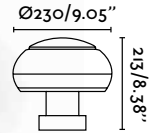

post lamp

74392

● dark grey
gris oscuro

1XE27 20W NOT INCL. [I6467]

DIE CAST ALUMINIUM+OPAL POLYCARBONATE/
ALUMINIO INYECTADO+POLICARBONATO OPAL

A++ to B / 100-240V ~ 50-60 Hz / 1.6 kg/3.53 lb

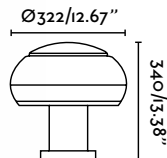

post lamp

74393

● dark grey
gris oscuro

3XE27 20W NOT INCL. [I6467]

DIE CAST ALUMINIUM+OPAL POLYCARBONATE/
ALUMINIO INYECTADO+POLICARBONATO OPAL

A++ to B / 100-240V ~ 50-60 Hz / 3.1 kg/6.83 lb

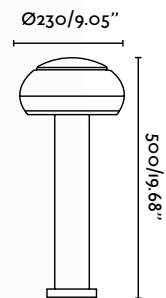

beacon

74394

● dark grey
gris oscuro

1XE27 20W NOT INCL. [I6467]

DIE CAST ALUMINIUM+OPAL POLYCARBONATE/
ALUMINIO INYECTADO+POLICARBONATO OPAL

A++ to B / 100-240V ~ 50-60 Hz / 2.16 kg/4.76 lb



trial

by Manel Llusçà

The formal and simple design of this series is reminiscent of those well-known american mailboxes combining straight lines with a slight arch at the top.

Con un diseño formal y sobrio, esta serie nos remite a los tan conocidos buzones americanos que combinan líneas rectas con una línea ligeramente arqueada en su parte superior.

D'un design sérieux et sobre, cette série rappelle les célèbres boîtes aux lettres américaines qui allient des lignes droites et une ligne légèrement arquée sur le dessus.



BULB INCLUDED
BOMBILLA INCLUIDA

wall lamp

74381

● dark grey
gris oscuro

HF

2XE27 20W INCL.

METAL+OPAL POLYCARBONATE/
METAL+POLICARBONATO OPAL

A++ to B / 100-240V ~ 50-60 Hz / 1.95 kg/4.30 lb

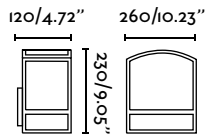

BULB INCLUDED
BOMBILLA INCLUIDA

post lamp

74382

● dark grey
gris oscuro

HF

1XE27 20W INCL.

METAL+OPAL POLYCARBONATE/
METAL+POLICARBONATO OPAL

A++ to B / 100-240V ~ 50-60 Hz / 2.24 kg/4.94 lb

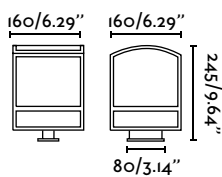

BULB INCLUDED
BOMBILLA INCLUIDA

beacon

74385

● dark grey
gris oscuro

HF

1XE27 20W INCL.

METAL+OPAL POLYCARBONATE/
METAL+POLICARBONATO OPAL

A++ to B / 100-240V ~ 50-60 Hz / 3.4 kg/7.50 lb

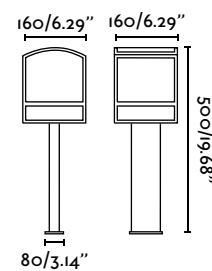

HF

Until stock exhaustion
Hasta final de stock
Jusqu'à la fin de stock

series
series
séries
serie

aLP [new]

Family of stylized lines that works by LED technology. It is available in dark gray.

Familia de estilizadas líneas que funciona mediante tecnología LED. Está disponible en gris oscuro.

Family of stylized lines that works by LED technology. It is available in dark gray.



[new] **wall lamp**

74450

● dark grey
gris oscuro

SMD LED 6W 3000K 190LM CRI<80 INCL. DRIVER INCL.
METAL+OPAL POLYCARBONATE/
METAL+POLICARBONATO OPAL

A+ / 220-240V ~ 50-60 Hz / 0.54 kg/1.19 lb

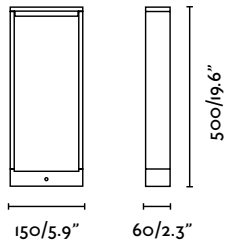
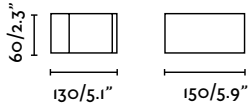

[new] **beacon**

74451

● dark grey
gris oscuro

SMD LED 6W 3000K 190LM CRI<80 INCL. DRIVER INCL.
METAL+OPAL POLYCARBONATE/
METAL+POLICARBONATO OPAL

A+ / 220-240V ~ 50-60 Hz / 1.14 kg/1.51 lb



[new] **beacon**

74452

● dark grey
gris oscuro

SMD LED 6W 3000K 190LM CRI<80 INCL. DRIVER INCL.
METAL+OPAL POLYCARBONATE/
METAL+POLICARBONATO OPAL

A+ / 220-240V ~ 50-60 Hz / 1.51 kg/3.33 lb

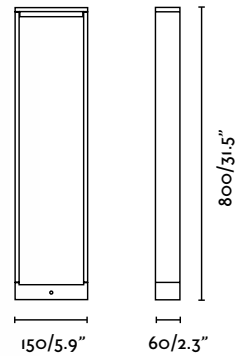

dAs

DAS is a trendy set for outdoor lighting, which incorporates LED technology and comprises one wall lamp and two beacons.

DAS es una serie para iluminación exterior de líneas actuales, que incorpora tecnología LED, formada por un aplique y dos balizas.

DAS est une série pour éclairage extérieur de lignes actuelles, qui comprend la technologie LED, formée d'une applique et de deux balises.

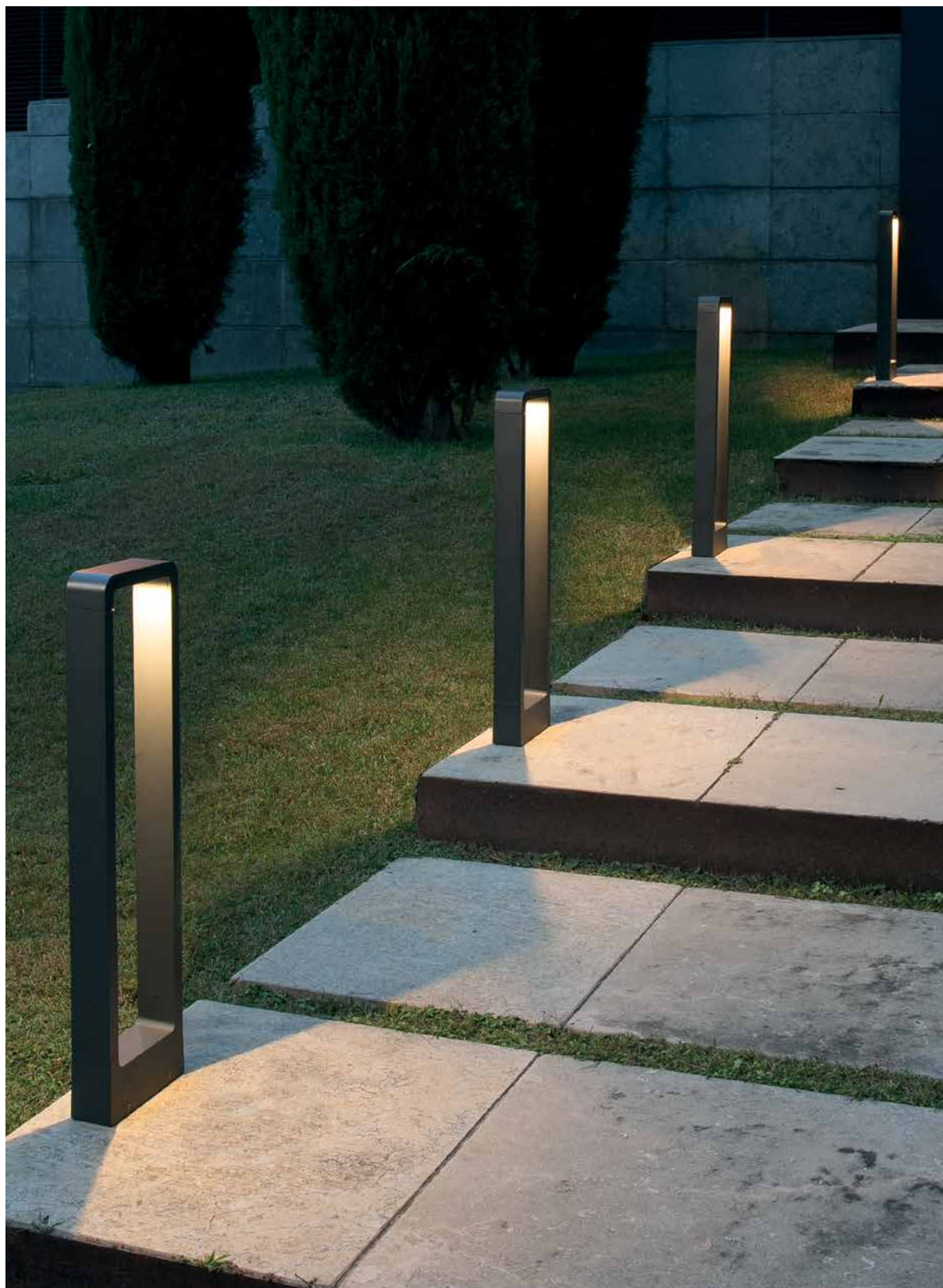

wall lamp

75518

dark grey
gris oscuro

COB LED 5W 3000K 140LM CRI<80 INCL. DRIVER INCL.

DIE CAST ALUMINIUM+TRANSPARENT GLASS/
ALUMINIO INYECTADO+CRISTAL TRANSPARENTE

A++ to A / 110-240V ~ 50-60 Hz / 0.7 kg/1.54 lb

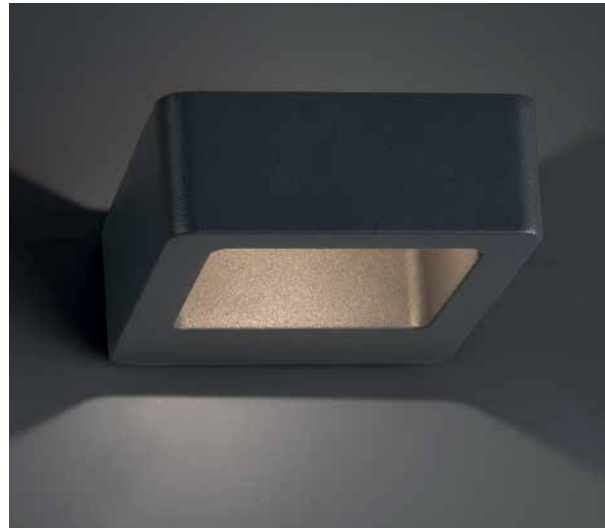
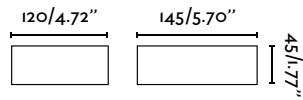

Ref. 75520



Ref. 75519

beacon

75519

dark grey
gris oscuro

75520

dark grey
gris oscuro

COB LED 5W 3000K 140LM CRI<80 INCL. DRIVER INCL.

DIE CAST ALUMINIUM+TRANSPARENT GLASS/
ALUMINIO INYECTADO+CRISTAL TRANSPARENTE

A++ to A / 110-240V ~ 50-60 Hz / 1.5-2.3 kg/3.31-5.07 lb

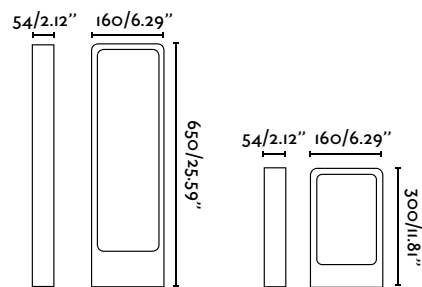

Ref. 75520

Ref. 75519

giNa [new]

Family composed of a wall light and beacon. They are made of injected aluminum with a transparent glass diffuser.

Familia compuesta por aplique y baliza. Ambos realizados en aluminio inyectado y con difusor de cristal transparente.

Famille composée d'applique et de balise. Les deux faite en aluminium injecté et diffuseur en verre transparent.





wall lamp

71366  white
blanco

71367  black
negro

[new] 71363  dark grey
gris oscuro

1 XGU10 35W NOT INCL. [14030] [LED 14141]
DIE CAST ALUMINIUM+TRANSPARENT GLASS/
ALUMINIO INYECTADO+CRISTAL TRANSPARENTE
A++ to E / 100-240V ~ 50-60 Hz / 0.44 kg/0.97 lb

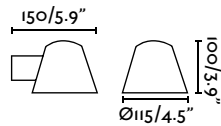

[new] beacon

71352  dark grey
gris oscuro

1 XGU10 35W NOT INCL. [14030] [LED 14141]
DIE CAST ALUMINIUM+TRANSPARENT GLASS/
ALUMINIO INYECTADO+CRISTAL TRANSPARENTE
A++ to E / 100-240V ~ 50-60 Hz / 1.49 kg/3.28 lb

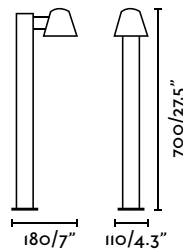

giZa [new]

Family composed of a wall light, post lamp and beacon. It works by LED technology and it is available in dark gray.

Familia compuesta por aplique, sobremuro y baliza. Funciona mediante tecnología LED y está disponible en gris oscuro.

Famille de produit composée d'applique, de lampe mural et de balise. Elle fonctionne avec la technologie LED et est disponible en gris foncé.



[new] **wall lamp**

70766  dark grey
gris oscuro

COB LED 15W 3000K 500LM INCL. DRIVER INCL
DIE CAST ALUMINIUM+TRANSPARENT POLYCARBONATE+ALUMINIUM/
ALUMINIO INYECTADO+POLICARBONATO TRANSPARENTE+ALUMINIO

A / 100-240V ~ 50-60 Hz / 1.97 kg/4.34 lb

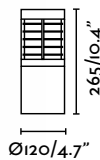
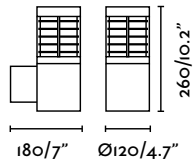
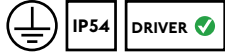

[new] **post lamp**

70767  dark grey
gris oscuro

COB LED 15W 3000K 500LM INCL. DRIVER INCL
DIE CAST ALUMINIUM+TRANSPARENT POLYCARBONATE+ALUMINIUM/
ALUMINIO INYECTADO+POLICARBONATO TRANSPARENTE+ALUMINIO

A / 100-240V ~ 50-60 Hz / 1.70 kg/3.75 lb



[new] **beacon**

70768  dark grey
gris oscuro

COB LED 15W 3000K 500LM INCL. DRIVER INCL
DIE CAST ALUMINIUM+TRANSPARENT POLYCARBONATE+ALUMINIUM/
ALUMINIO INYECTADO+POLICARBONATO TRANSPARENTE+ALUMINIO

A / 100-240V ~ 50-60 Hz / 2.68 kg/5.91 lb

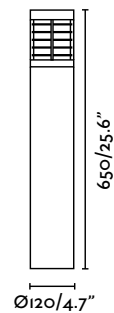

sAga [new]

Family composed by wall lamp and beacon that works through LED technology. It is made of aluminum with an opal polycarbonate diffuser.

Familia compuesta por aplique y baliza que funciona mediante tecnología LED. Realizada en aluminio con difusor de policarbonato opal.

Famille de produit composée d'applique et balise utilisant la Technologies LED. Fabriquée en aluminium de polycarbonate opaque.



[new] **wall lamp**

75526



dark grey
gris oscuro

SMD LED 9W 4000K 392LM CRI>80 INCL. DRIVER INCL.
ALUMINIUM+POLYCARBONATE OPAL/
ALUMINIO+POLICARBONATO OPAL

A++ to A / 100-240V ~ 50-60 Hz / 0.88 kg/1.94 lb



IP54

DRIVER

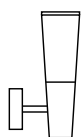

145/5.7"

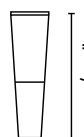

105/4.1"

310/12.2"



[new] **beacon**

75527



dark grey
gris oscuro

SMD LED 9W 4000K 392LM CRI>80 INCL. DRIVER INCL.
ALUMINIUM+OPAL POLYCARBONATE/
ALUMINIO+POLICARBONATO OPAL

A++ to A / 100-240V ~ 50-60 Hz / 1.34 kg/2.95 lb



IP54

DRIVER

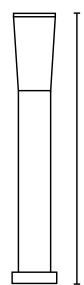

650/25.6"

Ø120/4.7"

rounder [new]

Outdoor family made of injected aluminum that works by LED technology. It consists of a wall light and a beacon in dark grey.

Familia de exterior realizada en aluminio inyectado que funciona mediante tecnología LED. Está formada por un aplique y una baliza en gris oscuro.

Famille de produit d'extérieur réalisé en aluminium injecté fonctionnant avec la technologie LED. Gamme composée d'applique et de balise gris foncé.





[new] **wall lamp**

72400

● dark grey
gris oscuro

SMD LED 8W 3000K 434LM CRI>80 INCL. DRIVER INCL.

DIE CAST ALUMINIUM+OPAL GLASS/
ALUMINIO INYECTADO+CRISTAL OPAL

A / 220-240V ~ 50-60 Hz / 1.04 kg/2.29 lb

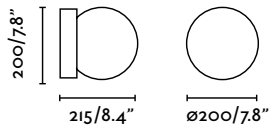
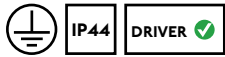

[new] **beacon**

72401

● dark grey
gris oscuro

SMD LED 8W 3000K 434LM CRI>80 INCL. DRIVER INCL.

DIE CAST ALUMINIUM+OPAL GLASS/
ALUMINIO INYECTADO+CRISTAL OPAL

A / 220-240V ~ 50-60 Hz / 3.64 kg/8.02 lb

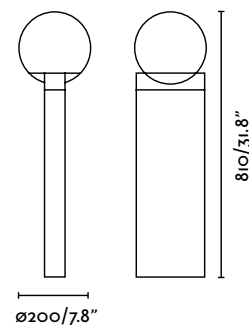

elEn [new]

Ellen is an outdoor family composed of a wall light and a hanging light. This is modern style series with LED and it is made of injected aluminum.

Ellen es una familia de exterior compuesta por un aplique y un colgante. Esta serie de estilo moderno es de LED y está realizada en aluminio inyectado.

Ellen est une famille de produit pour extérieur composée d'applique et suspendue. Cette série de style moderne fonctionne avec la technologie LED et est fabriquée en aluminium injecté.



[new] **wall lamp**

72402

● dark grey
gris oscuro

SMD LED 8W 3000K 546LM CRI>80 INCL. DRIVER INCL.
DIE CAST ALUMINIUM+OPAL POLYCARBONATE/
ALUMINIO INYECTADO+POLICARBONATO OPAL

A+ / 220-240V ~ 50-60 Hz / 1.13 kg/2.49 lb

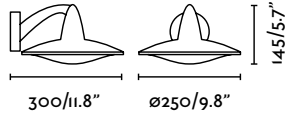
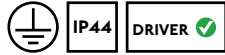

[new] **pendant lamp**

72403

● dark grey
gris oscuro

SMD LED 8W 3000K 546LM CRI>80 INCL. DRIVER INCL.
DIE CAST ALUMINIUM+OPAL POLYCARBONATE/
ALUMINIO INYECTADO+POLICARBONATO OPAL

A+ / 220-240V ~ 50-60 Hz / 1.08 kg/2.38 lb

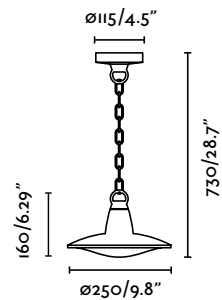

beRet

BERET is a trendy and simple set for outdoor lighting, which incorporates LED technology and comprises two beacon lamps and one lamp post.

BERET es una serie para iluminación exterior de líneas actuales y sencillas, que incorpora tecnología LED, formada por dos balizas y una farola.

BERET est une série pour l'éclairage extérieur de lignes actuelles et simples, qui comprend la technologie LED, formée de deux balises et d'un réverbère.



pole lamp

75524



dark grey
gris oscuro

SMD LED I6W 4000K 625LM CRI>80 INCL. DRIVER INCL.

ALUMINIUM+OPAL PMMA/
ALUMINIO+PMMA OPAL

A++ to A / 220-240V ~ 50-60 Hz / 3.15 kg/6.94 lb



IP54

DRIVER



Ø65/2.55"

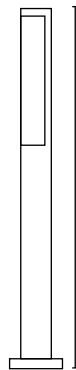

1800/70.86"



[new] **wall lamp**

75525

dark grey
gris oscuro

SMD LED 8W 3000K 350LM CRI>80 INCL. DRIVER INCL.

ALUMINIUM+OPAL PMMA/
ALUMINIO+PMMA OPAL

A / 220-240V ~ 50-60 Hz / 0.85 kg/1.87 lb

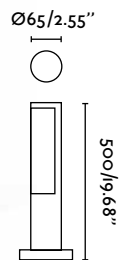
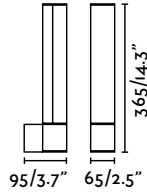
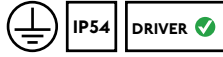

beacon

75522

dark grey
gris oscuro

SMD LED 8W 4000K 350LM CRI>80 INCL. DRIVER INCL.

ALUMINIUM+OPAL PMMA/
ALUMINIO+PMMA OPAL

A++ to A / 220-240V ~ 50-60 Hz / 0.98 kg/2.16 lb

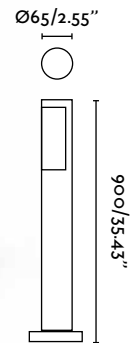
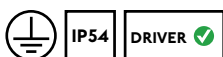

beacon

75523

dark grey
gris oscuro

SMD LED 8W 4000K 350LM CRI>80 INCL. DRIVER INCL.

ALUMINIUM+OPAL PMMA/
ALUMINIO+PMMA OPAL

A++ to A / 220-240V ~ 50-60 Hz / 1.86 kg/4.10 lb



nEo

NEO is a set for outdoor lighting made from die cast aluminium with a PMMA opal diffuser.

NEO es una familia para terraza y jardín fabricado en aluminio inyectado y difusor en PMMA opal.

NEO est une série d'extérieur fabriqué en fonte d'aluminium et diffuseur PMMA opale.



wall lamp

70629

● dark grey
gris oscuro

SMD LED 5W 4000K 320LM CRI<80 INCL. DRIVER INCL.

DIE CAST ALUMINIUM+OPAL PMMA/
ALUMINIO INYECTADO+PMMA OPAL

A++ / 220-240V ~ 50-60 Hz / 0.8 kg/1.76 lb

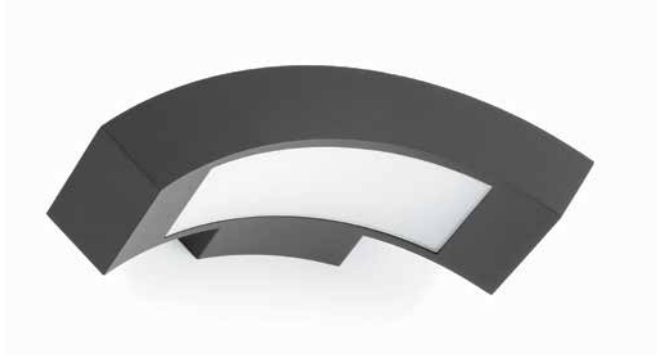
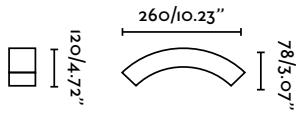

Ref. 70630



Ref. 70631

beacon

70630

● dark grey
gris oscuro

70631

● dark grey
gris oscuro

SMD LED 5W 4000K 320LM CRI<80 INCL. DRIVER INCL.

DIE CAST ALUMINIUM+OPAL PMMA/
ALUMINIO INYECTADO+PMMA OPAL

A++ / 220-240V ~ 50-60 Hz / 1.3 kg/2.87 lb

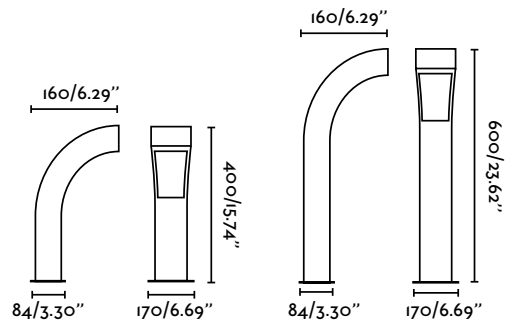
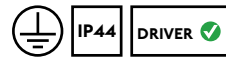

Ref. 70630

Ref. 70631

wilMa

WILMA is a modern set for outdoor lighting made from aluminium with a translucent PC diffuser.

WILMA es una serie moderna para iluminación exterior fabricada en aluminio y difusor de policarbonato translúcido.

WILMA est une série moderne pour éclairage extérieur fabriqué en aluminium et diffuseur PC translucide.



wall lamp

75000



dark grey
gris oscuro

I XE27 MAX 100W NOT INCL. [16468] [LED I7059]
DIE CAST ALUMINIUM+TRANSLUCENT POLYCARBONATE/
ALUMINIO INYECTADO+POLICARBONATO TRANSLÚCIDO
A++ to E / 100-240V ~ 50-60 Hz / 2.14 kg/4.72 lb

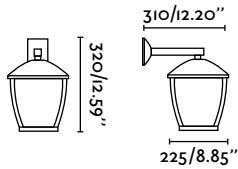

74998



dark grey
gris oscuro

I XE27 II W NOT INCL. [16468] [LED I7059]
DIE CAST ALUMINIUM+TRANSLUCENT POLYCARBONATE/
ALUMINIO INYECTADO+POLICARBONATO TRANSLÚCIDO
A++ to B / 100-240V ~ 50-60 Hz / 1.3 kg/2.87 lb

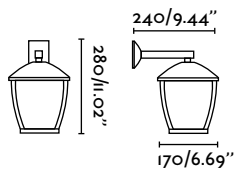

pendant

75002



dark grey
gris oscuro

I XE27 MAX 100W NOT INCL. [16468] [LED I7059]
DIE CAST ALUMINIUM+TRANSLUCENT POLYCARBONATE/
ALUMINIO INYECTADO+POLICARBONATO TRANSLÚCIDO
A++ to E / 100-240V ~ 50-60 Hz / 2.09 kg/4.61 lb

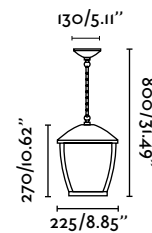

74996



dark grey
gris oscuro

I XE27 II W NOT INCL. [16468] [LED I7059]
DIE CAST ALUMINIUM+TRANSLUCENT POLYCARBONATE/
ALUMINIO INYECTADO+POLICARBONATO TRANSLÚCIDO
A++ to B / 100-240V ~ 50-60 Hz / 1.3 kg/2.87 lb

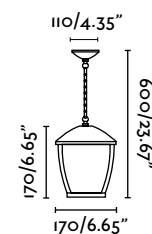

wilMa



post lamp

75001



I XE27 MAX 100W NOT INCL. [16468] [LED I7059]
DIE CAST ALUMINIUM+TRANSLUCENT POLYCARBONATE/
ALUMINIO INYECTADO+POLICARBONATO TRANSLÚCIDO

A++ to E / 100-240V ~ 50-60 Hz / 2.7 kg/5.95 Lb

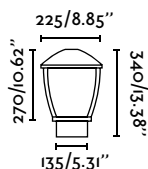

74997



I XE27 II W NOT INCL. [16468] [LED I7059]
DIE CAST ALUMINIUM+TRANSLUCENT POLYCARBONATE/
ALUMINIO INYECTADO+POLICARBONATO TRANSLÚCIDO

A++ to B / 100-240V ~ 50-60 Hz / 1.5 kg/3.31 Lb

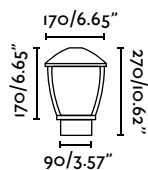

beacon

75003



I XE27 MAX 100W NOT INCL. [16468] [LED I7059]
DIE CAST ALUMINIUM+TRANSLUCENT POLYCARBONATE/
ALUMINIO INYECTADO+POLICARBONATO TRANSLÚCIDO

A++ to E / 100-240V ~ 50-60 Hz / 4.7 kg/10.36 Lb

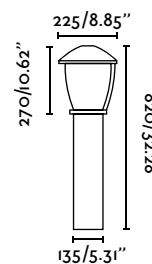

74999



I XE27 II W NOT INCL. [16468] [LED I7059]
DIE CAST ALUMINIUM+TRANSLUCENT POLYCARBONATE/
ALUMINIO INYECTADO+POLICARBONATO TRANSLÚCIDO

A++ to B / 100-240V ~ 50-60 Hz / 2.1 kg/4.63 Lb

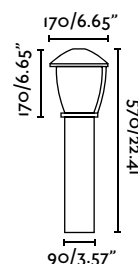

lOng

LONG is a modern set for outdoor lighting, comprising two beacon lamps and one wall lamp.

LONG es una serie moderna para iluminación exterior, formada por dos balizas y un aplique.

LONG est une série moderne pour éclairage extérieur, formée de deux balises et une applique.



wall lamp

75515

dark grey
gris oscuro

1 X E27 MAX 18W NOT INCL. [I6466] [LED I7059]
DIE CAST ALUMINIUM+TRANSLUCENT GLASS/
ALUMINIO INYECTADO+CRISTAL TRANSLÚCIDO
A++ to B / 100-240V ~ 50-60 Hz / 1.18 kg/2.60 lb

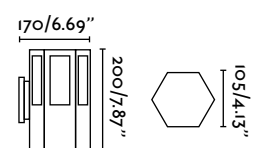



post lamp

75514



dark grey
gris oscuro

1 X E27 MAX 18W NOT INCL. [16466] [LED 17059]
DIE CAST ALUMINIUM+TRANSLUCENT GLASS/
ALUMINIO INYECTADO+CRISTAL TRANSLÚCIDO
A++ to B / 100-240V ~ 50-60 Hz / 0.82 kg/1.81 lb

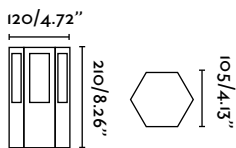

beacon

75516



dark grey
gris oscuro

1 X E27 MAX 18W NOT INCL. [16466] [LED 17059]
DIE CAST ALUMINIUM+TRANSLUCENT GLASS/
ALUMINIO INYECTADO+CRISTAL TRANSLÚCIDO
A++ to B / 100-240V ~ 50-60 Hz / 2.35 kg/5.18 lb

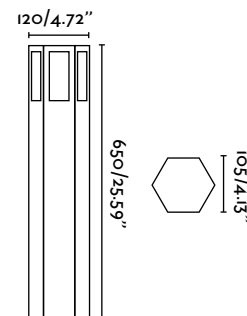

caRtago

CARTAGO is a set for outdoor lighting made from aluminium die casting with a polycarbonate opal diffuser.

CARTAGO es una serie para iluminación exterior fabricada en aluminio y difusor de policarbonato opal.

CARTAGO est une série pour éclairage extérieur fabriqué en aluminium et et diffuseur polycarbonate opale.

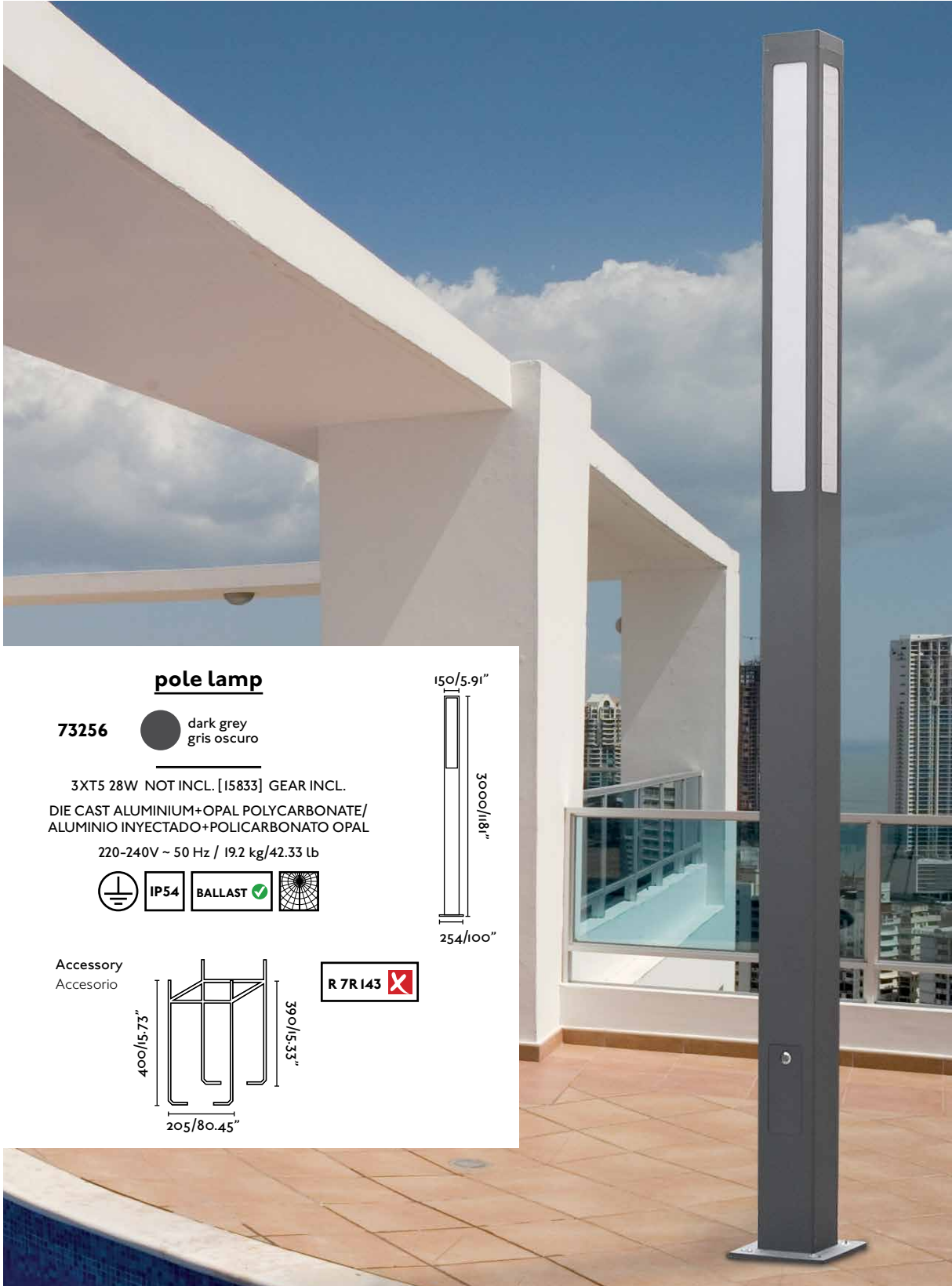

pole lamp

73256

● dark grey
gris oscuro

3XT5 28W NOT INCL. [15833] GEAR INCL.
DIE CAST ALUMINIUM+OPAL POLYCARBONATE/
ALUMINIO INYECTADO+POLICARBONATO OPAL

220-240V ~ 50 Hz / 19.2 kg/42.33 lb

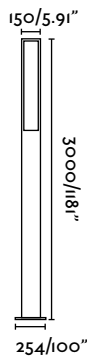

Accessory
Accesorio

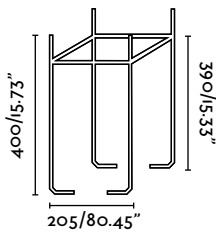

R 7R 143

post lamp

73254

● dark grey
gris oscuro

1XE27 15W NOT INCL. [I6466] [LED I7059]

DIE CAST ALUMINIUM+OPAL POLYCARBONATE/
ALUMINIO INYECTADO+POLICARBONATO OPAL

A++ to B / 100-240V ~ 50-60 Hz / 1.46 kg/3.22 lb

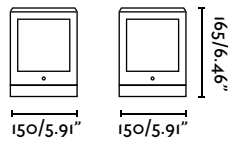

IP65

beacon

73255

● dark grey
gris oscuro

1XE27 15W NOT INCL. [I6466] [LED I7059]

DIE CAST ALUMINIUM+OPAL POLYCARBONATE/
ALUMINIO INYECTADO+POLICARBONATO OPAL

A++ to B / 100-240V ~ 50-60 Hz / 3.6 kg/7.94 lb

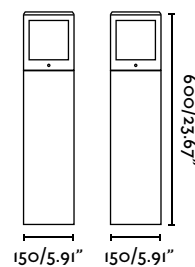

tarrAco

TARRACO is a set for outdoor lighting made from aluminium die casting with a polycarbonate opal diffuser.

TARRACO es una familia para terraza y jardín fabricado en aluminio inyectado y difusor en policarbonato opal.

TARRACO est une série d'extérieur fabriqué en fonte d'aluminium et diffuseur polycarbonate opale.



wall lamp

73260



1 XE27 15W NOT INCL. [16466] [LED 17059]

DIE CAST ALUMINIUM+OPAL POLYCARBONATE/
ALUMINIO INYECTADO+POLICARBONATO OPAL

A++ to B / 100-240V ~ 50-60 Hz / 0.69 kg/1.52 lb

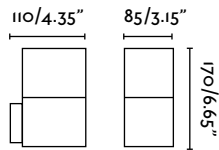

beacon

73261



1 XE27 15W NOT INCL. [16466] [LED 17059]

DIE CAST ALUMINIUM+OPAL POLYCARBONATE/
ALUMINIO INYECTADO+POLICARBONATO OPAL

A++ to B / 100-240V ~ 50-60 Hz / 1.4 kg/3.09 lb

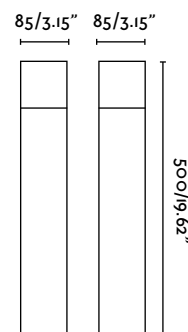

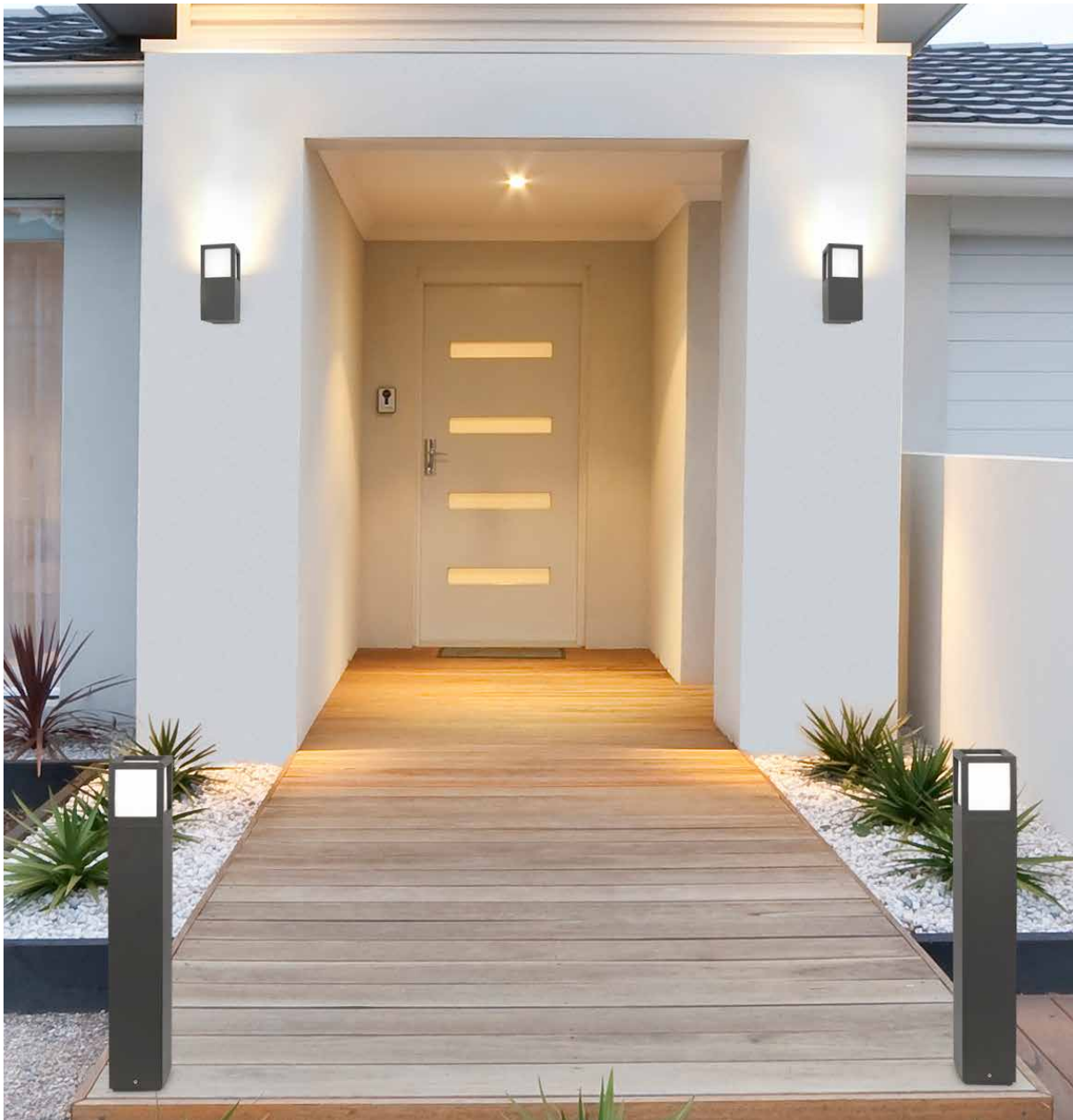

onZe wall lamp

70760



1 X E27 20W NOT INCL. [16467] [LED 17059]
DIE CAST ALUMINIUM+OPAL POLYCARBONATE/
ALUMINIO INYECTADO+POLICARBONATO OPAL
A++ to B / 100-240V ~ 50-60 Hz / 1.6 kg/3.53 lb

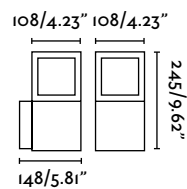

onZe beacon

70761



1 X E27 20W NOT INCL. [16467] [LED 17059]
DIE CAST ALUMINIUM+OPAL POLYCARBONATE/
ALUMINIO INYECTADO+POLICARBONATO OPAL
A++ to B / 100-240V ~ 50-60 Hz / 3.1 kg/6.83 lb

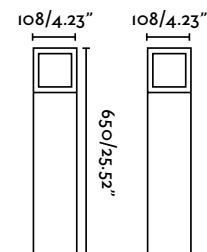

pAlm

wall lamp

74425

dark grey
gris oscuro

HF

1 X E27 20W NOT INCL. [16467] [LED 17453]

DIE CAST ALUMINIUM+OPAL PMMA/
ALUMINIO INYECTADO+PMMA OPAL

A++ to B / 100-240V ~ 50-60 Hz / 1.64 kg/3.62 lb

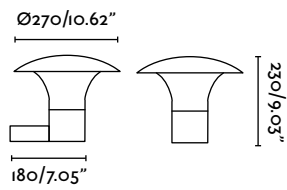

pAlm

beacon

74426

dark grey
gris oscuro

HF

1 X E27 20W NOT INCL. [16467] [LED 17453]

DIE CAST ALUMINIUM+OPAL PMMA/
ALUMINIO INYECTADO+PMMA OPAL

A++ to B / 100-240V ~ 50-60 Hz / 2.03 kg/4.48 lb

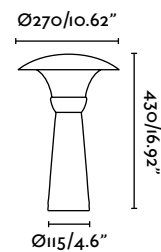

HF Until stock exhaustion
Hasta final de stock
Jusqu'à la fin de stock

sOL



pole lamp

74390



black
negro

3XE27 MAX 60W NOT INCL. [16467] [LED 17059]

DIE CAST ALUMINIUM+OPAL GLASS/
ALUMINIO INYECTADO+CRISTAL OPAL

A++ to E / 100-240V ~ 50-60 Hz / 11.9 kg/26.23 lb

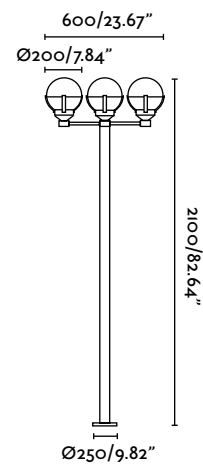

wall lamp

74387

black
negro

1XE27 MAX 60W NOT INCL. [16467] [LED I7059]

DIE CAST ALUMINIUM+OPAL GLASS/
ALUMINIO INYECTADO+CRISTAL OPAL

A++ to E / 100-240V ~ 50-60 Hz / 1.9 kg/4.19 lb

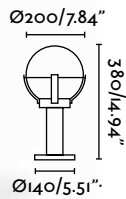
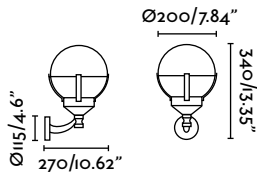

post lamp

74388

black
negro

1XE27 MAX 60W NOT INCL. [16467] [LED I7059]

DIE CAST ALUMINIUM+OPAL GLASS/
ALUMINIO INYECTADO+CRISTAL OPAL

A++ to E / 100-240V ~ 50-60 Hz / 2.06 kg/4.54 lb

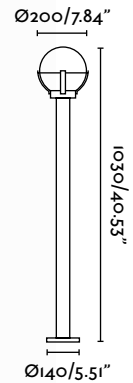

beacon

74389

black
negro

1XE27 MAX 60W NOT INCL. [16467] [LED I7059]

DIE CAST ALUMINIUM+OPAL GLASS/
ALUMINIO INYECTADO+CRISTAL OPAL

A++ to E / 100-240V ~ 50-60 Hz / 3.2 kg/7.09 lb



sAil





pendant

71358  white
blanco

71359  black
negro

1XE27 MAX 60W NOT INCL. [16467] [LED I7059]

DIE CAST ALUMINIUM+OPAL GLASS/
ALUMINIO INYECTADO+CRISTAL OPAL

A++ to E / 100-240V ~ 50-60 Hz / 1.22 kg/2.69 lb

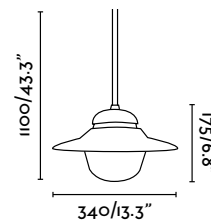

wall lamp

71356  white
blanco

71357  black
negro

1XE27 MAX 60W NOT INCL. [16467] [LED I7059]

DIE CAST ALUMINIUM+OPAL GLASS/
ALUMINIO INYECTADO+CRISTAL OPAL

A++ to E / 100-240V ~ 50-60 Hz / 1.22 kg/2.69 lb

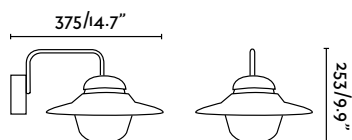

mitRa





wall lamp

71146

● brushed brown
marrón cepillado

1 XE27 60W NOT INCL. [16467] [LED 17455]

METAL+ALUMINIUM+GLASS BUBBLE/
METAL+ALUMINIO+CRISTAL BURBUJA

A++ to E / 100-240V ~ 50-60 Hz / 1.7 kg/3.75 lb

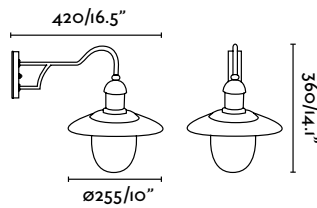

pendant

71145

● brushed brown
marrón cepillado

1 XE27 60W NOT INCL. [16467] [LED 17453]

METAL+ALUMINIUM+GLASS BUBBLE/
METAL+ALUMINIO+CRISTAL BURBUJA

A++ to E / 100-240V ~ 50-60 Hz / 1.6 kg/3.53 lb

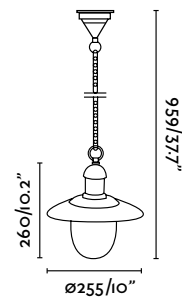

esToril



pendant-g

71143



rust
marrón óxido

1 X E27 MAX 60W NOT INCL. [16592] [LED 17059]

METAL+GLASS BUBBLE/
METAL+CRISTAL BURBUJA

A++ to E / 100-240V ~ 50-60 Hz / 1.77 kg/3.90 lb

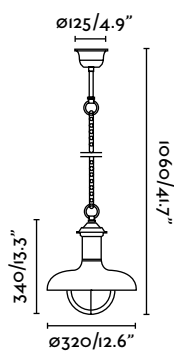

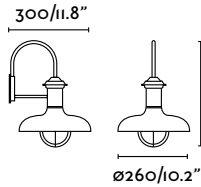

wall lamp-p

71140



rust
marrón óxido

1 XE27 MAX 60W NOT INCL. [16592] [LED I7059]

METAL+GLASS BUBBLE/
METAL+CRISTAL BURBUJA

A++ to E / 100-240V ~ 50-60 Hz / 1.6 kg/3.53 lb

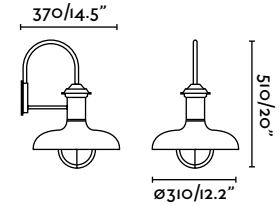

wall lamp-g

71141



rust
marrón óxido

1 XE27 MAX 60W NOT INCL. [16592] [LED I7059]

METAL+GLASS BUBBLE/
METAL+CRISTAL BURBUJA

A++ to E / 100-240V ~ 50-60 Hz / 1.8 kg/3.97 lb



pendant-p

71142



rust
marrón óxido

1 XE27 MAX 60W NOT INCL. [16592] [LED I7059]

METAL+GLASS BUBBLE/
METAL+CRISTAL BURBUJA

A++ to E / 100-240V ~ 50-60 Hz / 1.6 kg/3.53 lb

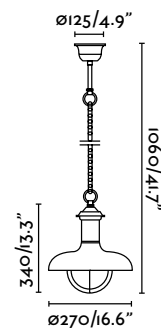

náuTica

wall lamp

71128  rust
marrón óxido

71129  rust
marrón óxido

1 XE27 11 W NOT INCL. [16620] [LED 17453]

METAL+GLASS BUBBLE/
METAL+CRISTAL BURBUJA

A++ to B / 100-240V ~ 50-60 Hz / 1.2 kg/2.65 lb

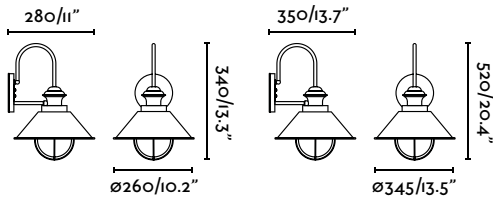

Ref. 71128

Ref. 71129



wall lamp

71110  rust
marrón óxido

1 XE27 11 W NOT INCL. [16620] [LED 17453]

METAL+GLASS BUBBLE/
METAL+CRISTAL BURBUJA

A++ to B / 100-240V ~ 50-60 Hz / 1.3 kg/2.87 lb

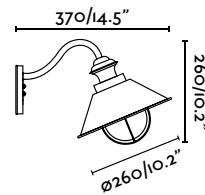

wall lamp

71109  rust
marrón óxido

1 XE27 11 W NOT INCL. [16620] [LED 17453]

METAL+GLASS BUBBLE/
METAL+CRISTAL BURBUJA

A++ to B / 100-240V ~ 50-60 Hz / 2.53 kg/5.58 lb

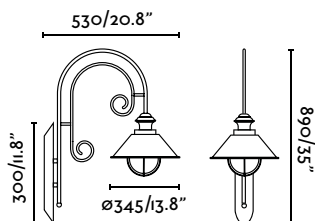

pendant

71113

rust
marrón óxido

2XE27 II W NOT INCL. [16620] [LED 17453]

METAL+GLASS BUBBLE/
METAL+CRISTAL BURBUJA

A++ to B / 100-240V ~ 50-60 Hz / 3.1 kg/6.83 lb

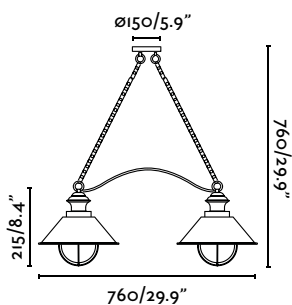

pendant

71114

rust
marrón óxido

3XE27 II W NOT INCL. [16620] [LED 17453]

METAL+GLASS BUBBLE/
METAL+CRISTAL BURBUJA

A++ to B / 100-240V ~ 50-60 Hz / 4.84 kg/10.67 lb

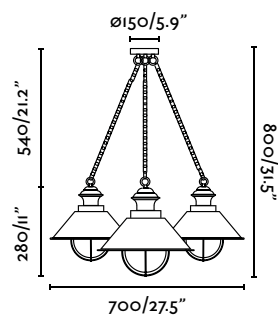

náutica

pendant-p

71138

 rust
marrón óxido

1 XE27 II W NOT INCL. [I6620] [LED I7453]

METAL+GLASS BUBBLE/
METAL+CRISTAL BURBUJA

A++ to B / 100-240V ~ 50-60 Hz / 1.2 kg/2.65 lb

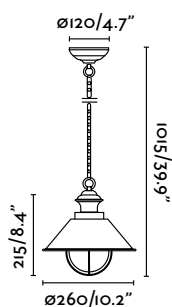

pendant-g

71139

 rust
marrón óxido

1 XE27 II W NOT INCL. [I6620] [LED I7453]

METAL+GLASS BUBBLE/
METAL+CRISTAL BURBUJA

A++ to B / 100-240V ~ 50-60 Hz / 1.69 kg/3.73 lb

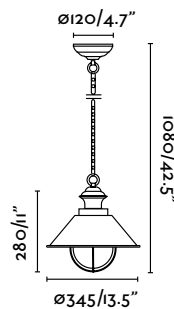

pendant

71112

 rust
marrón óxido

3XE27 II W NOT INCL. [16620] [LED I7453]

METAL+GLASS BUBBLE/
METAL+CRISTAL BURBUJA

A++ to B / 100-240V ~ 50-60 Hz / 4.2 kg/9.26 lb

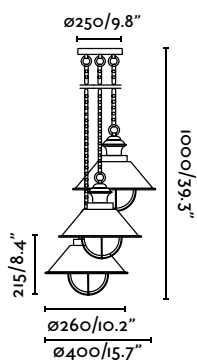

pendant

71111

 rust
marrón óxido

2XE27 II W NOT INCL. [16620] [LED I7453]

METAL+GLASS BUBBLE/
METAL+CRISTAL BURBUJA

A++ to B / 100-240V ~ 50-60 Hz / 2.98 kg/6.57 lb

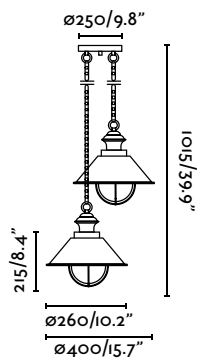

náutica



pole lamp

71118

 rust
marrón óxido

3XE27 II W NOT INCL. [16620] [LED 17453]

METAL+GLASS BUBBLE/
METAL+CRISTAL BURBUJA

A++ to B / 100-240V ~ 50-60 Hz / 16.1 kg/35.49 lb

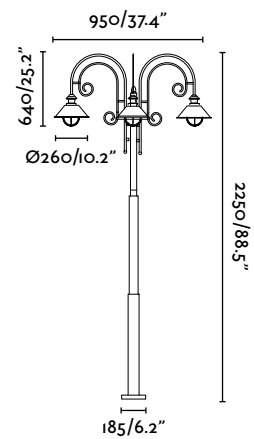

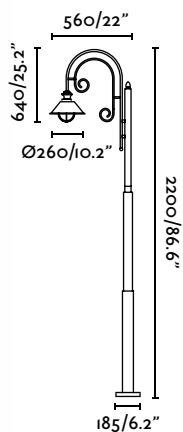

pole lamp

71116

● rust
marrón óxido

1 XE27 11W NOT INCL. [16620] [LED17453]

METAL+GLASS BUBBLE/
METAL+CRISTAL BURBUJA

A++ to B / 100-240V ~ 50-60 Hz / 11.86 kg/26.15 Lb

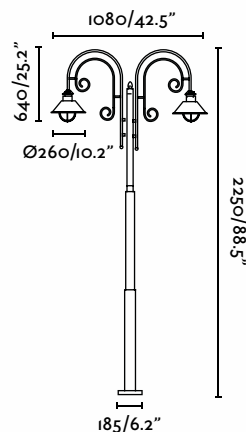

pole lamp

71117

● rust
marrón óxido

2 XE27 11W NOT INCL. [16620] [LED17453]

METAL+GLASS BUBBLE/
METAL+CRISTAL BURBUJA

A++ to B / 100-240V ~ 50-60 Hz / 16.26 kg/35.85 Lb



briNdisi



BULB INCLUDED
BOMBILLA INCLUIDA

pole lamp

74257

● dark grey
gris oscuro

1XE27 15W INCL.

74258

● dark grey
gris oscuro

3XE27 MAX 15W INCL.

DIE CAST ALUMINIUM+TRANSPARENT PVC/
ALUMINIO INYECTADO+PVC TRANSPARENTE

A+ to B / 220-240V ~ 50-60 Hz / 4.67 kg/10.30 lb

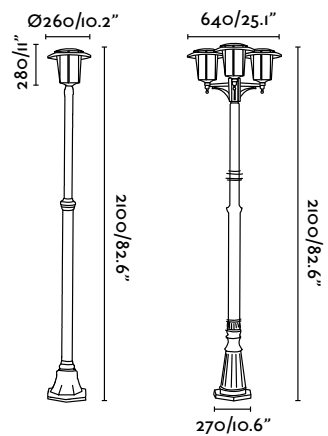

Ref. 74257

Ref. 74258

BULB INCLUDED
BOMBILLA INCLUIDA

wall lamp

74252

● dark grey
gris oscuro

1 XE27 15W INCL.

DIE CAST ALUMINIUM+TRANSPARENT PVC/
ALUMINIO INYECTADO+PVC TRANSPARENTE

A+ to B / 220-240V ~ 50-60 Hz / 1.3 kg/2.87 lb

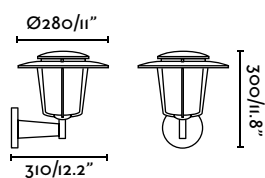

BULB INCLUDED
BOMBILLA INCLUIDA

post lamp

74254

● dark grey
gris oscuro

1 XE27 15W INCL.

DIE CAST ALUMINIUM+TRANSPARENT PVC/
ALUMINIO INYECTADO+PVC TRANSPARENTE

A+ to B / 220-240V ~ 50-60 Hz / 1.2 kg/2.65 lb

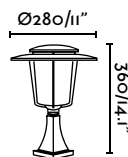

tOledo



BULB INCLUDED
BOMBILLA INCLUIDA

wall lamp

74132

old silver
plata envejecida

HF

1 X E27 MAX 60W NOT INCL. [16467 20W INCL.]

ALUMINIUM+RUSTIC GLASS/
ALUMINIO+CRISTAL RÚSTICO

A+ to B / 220-240V ~ 50-60 Hz / 1.88 kg/4.14 lb

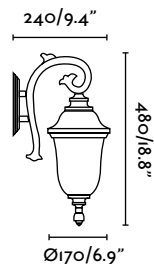

BULB INCLUDED
BOMBILLA INCLUIDA

post lamp

74134

old silver
plata envejecida

HF

1 X E27 MAX 60W NOT INCL. [16467 20W INCL.]

ALUMINIUM+RUSTIC GLASS/
ALUMINIO+CRISTAL RÚSTICO

A+ to B / 220-240V ~ 50-60 Hz / 1.4 kg/3.09 lb

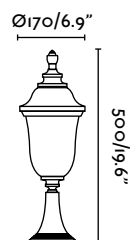

HF Until stock exhaustion
Hasta final de stock
Jusqu'à la fin de stock

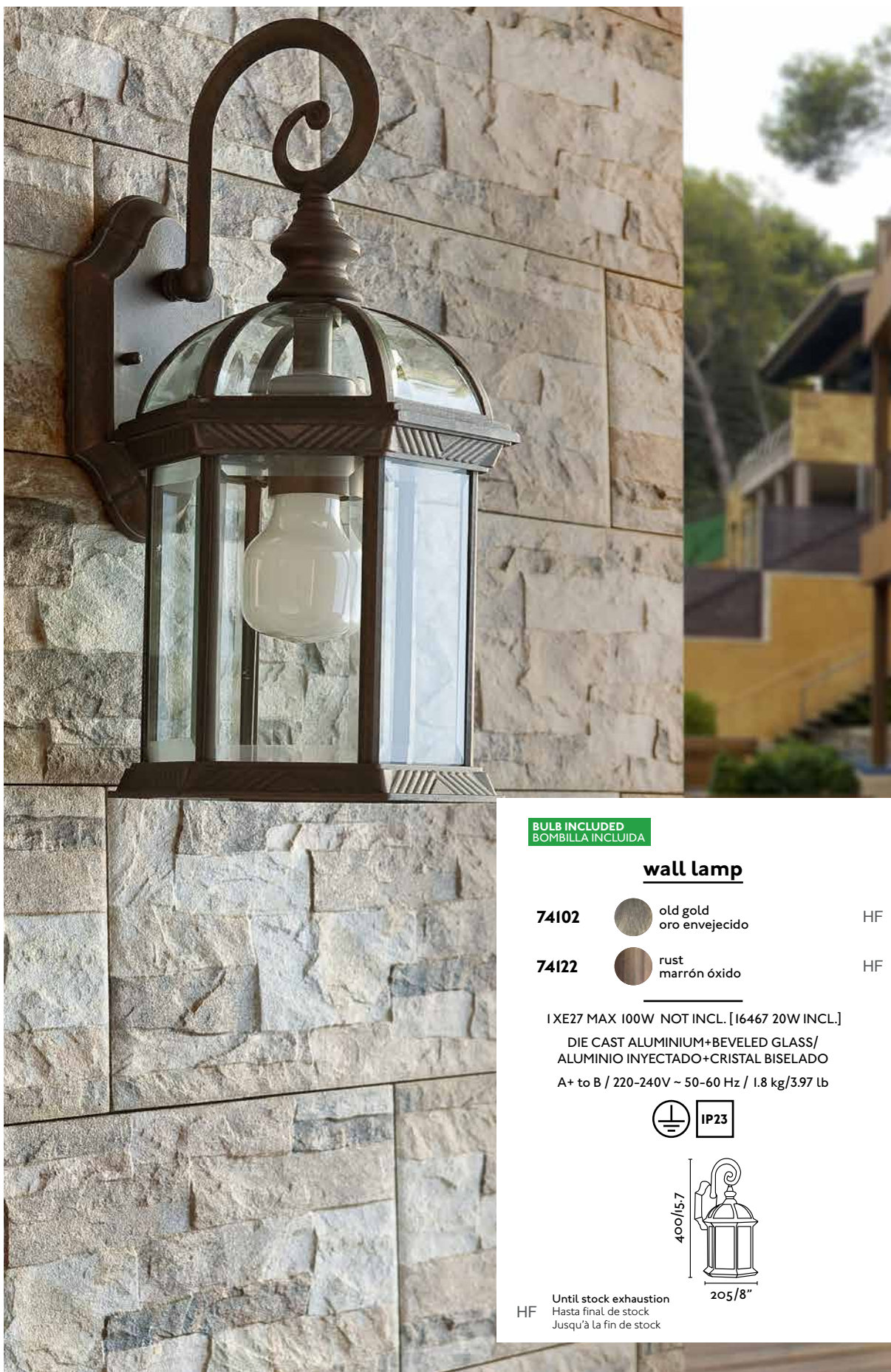

**BULB INCLUDED
BOMBILLA INCLUIDA**

wall lamp

74102  old gold
oro envejecido HF

74122  rust
marrón óxido HF

[XE27 MAX 100W NOT INCL. [I6467 20W INCL.]

DIE CAST ALUMINIUM+BEVELED GLASS/
ALUMINIO INYECTADO+CRISTAL BISELADO

A+ to B / 220-240V ~ 50-60 Hz / 1.8 kg/3.97 lb



HF Until stock exhaustion
Hasta final de stock
Jusqu'à la fin de stock



BULB INCLUDED
BOMBILLA INCLUIDA

post lamp

74104



old gold
oro envejecido

HF

1 X E27 MAX 100W NOT INCL. [16467 20W INCL.]

DIE CAST ALUMINIUM+BEVELED GLASS/
ALUMINIO INYECTADO+CRISTAL BISELADO

A+ to B / 220-240V ~ 50-60 Hz / 1.9 kg/4.19 lb

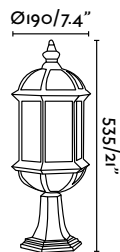

BULB INCLUDED
BOMBILLA INCLUIDA

pendant

74101



old gold
oro envejecido

HF

74121



rust
marrón óxido

HF

1 X E27 MAX 100W NOT INCL. [16467 20W INCL.]

DIE CAST ALUMINIUM+BEVELED GLASS/
ALUMINIO INYECTADO+CRISTAL BISELADO

A+ to B / 220-240V ~ 50-60 Hz / 1.7 kg/3.75 lb

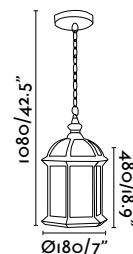

HF Until stock exhaustion
Hasta final de stock
Jusqu'à la fin de stock

pAris



BULB INCLUDED
BOMBILLA INCLUIDA

wall lamp

73432

● black
negro

1 X E27 MAX 60W NOT INCL. [16467 20W INCL.]

DIE CAST ALUMINIUM+TRANSPARENT GLASS/
ALUMINIO INYECTADO+CRISTAL TRANSPARENTE

A+ to B / 220-240V ~ 50-60 Hz / 19 kg/4.19 lb

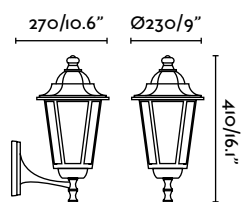



BULB INCLUDED
BOMBILLA INCLUIDA

post lamp

73434



black
negro

1 X E27 MAX 60W NOT INCL. [16467 20W INCL.]
DIE CAST ALUMINIUM+TRANSPARENT GLASS/
ALUMINIO INYECTADO+CRISTAL TRANSPARENTE
A+ to B / 220-240V ~ 50-60 Hz / 1.8 kg/3.97 lb

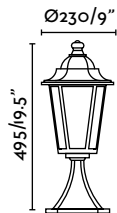

BULB INCLUDED
BOMBILLA INCLUIDA

pendant

73431



black
negro

1 X E27 MAX 60W NOT INCL. [16467 20W INCL.]
DIE CAST ALUMINIUM+TRANSPARENT GLASS/
ALUMINIO INYECTADO+CRISTAL TRANSPARENTE
A+ to B / 220-240V ~ 50-60 Hz / 1.9 kg/4.19 lb

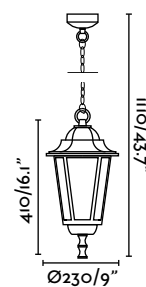

pAris



BULB INCLUDED
BOMBILLA INCLUIDA

pole lamp

73456



black
negro

2XE27 MAX 100W NOT INCL. [I6467 20W INCL.]
DIE CAST ALUMINIUM+TRANSPARENT GLASS/
ALUMINIO INYECTADO+CRISTAL TRANSPARENTE

A+ to B / 220-240V ~ 50-60 Hz / 11 kg/24.25 lb

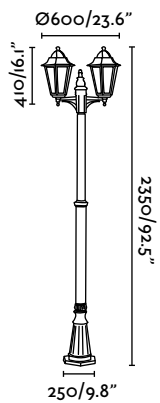

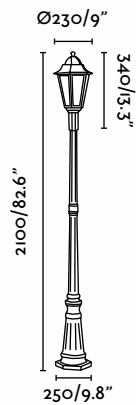

BULB INCLUDED
BOMBILLA INCLUIDA

pole lamp

73436 ● black
negro

1 X E27 MAX 100W NOT INCL. [16467 20W INCL.]
DIE CAST ALUMINIUM+TRANSPARENT GLASS/
ALUMINIO INYECTADO+CRISTAL TRANSPARENTE
A+ to B / 220-240V ~ 50-60 Hz / 6.2 kg/13.67 lb

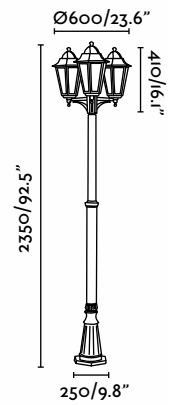

BULB INCLUDED
BOMBILLA INCLUIDA

pole lamp

73438 ● black
negro

3 X E27 MAX 100W NOT INCL. [16467 20W INCL.]
DIE CAST ALUMINIUM+TRANSPARENT GLASS/
ALUMINIO INYECTADO+CRISTAL TRANSPARENTE
A+ to B / 220-240V ~ 50-60 Hz / 11.89 kg/26.21 lb



beacons

balizas/balise/Lampioni bassi

 aGra	127
 aRisto	133
 chAndra [new]	126
 jaiPur	129
 nAya [new]	125
 seTe	130
 soRa	131
 suRat	131
 verNo	133



BEA CONNS







nAya

[new] post lamp

71198



dark grey
gris oscuro

SMD LED 6W 3000K 180LM INCL. DRIVER INCL.
ALUMINIUM+POLYCARBONATE OPAL/
ALUMINIO+POLICARBONATO OPAL
A / 100-240V ~ 50-60 Hz / 1.22 kg/2.69 lb

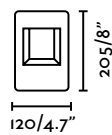

nAya

[new] beacon

71199



dark grey
gris oscuro

SMD LED 6W 3000K 180LM INCL. DRIVER INCL.
ALUMINIUM+POLYCARBONATE OPAL/
ALUMINIO+POLICARBONATO OPAL
A / 100-240V ~ 50-60 Hz / 2.24 kg/4.94 lb

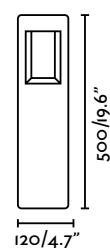



[new] **chAndra**

beacon

72298

● dark grey
gris oscuro

COB LED 7W 3000K 195LM CRI>80 INCL. DRIVER INCL.

ALUMINIUM+TEMPERED GLASS/
ALUMINIO+CRISTAL TEMPLADO

A++ to A /100-240V ~ 50-60 Hz / 1.64 kg/3.62 lb

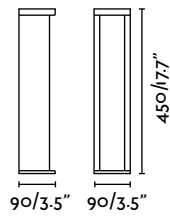

aGra

beacon

70755



dark grey
gris oscuro

70756



rust
marrón óxido

COB LED 5W 3000K 200LM INCL. DRIVER INCL.
DIE CAST ALUMINIUM+TRANSPARENT GLASS/
ALUMINIO INYECTADO+CRISTAL TRANSPARENTE

100-240V ~ 50-60 Hz / 1.2 kg/2.65 lb



IP54

DRIVER

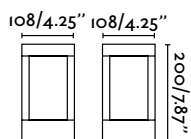

aGra

beacon

70753



dark grey
gris oscuro

70754



rust
marrón óxido

COB LED 6W 3000K 290LM INCL. DRIVER INCL.
DIE CAST ALUMINIUM+TRANSPARENT GLASS/
ALUMINIO INYECTADO+CRISTAL TRANSPARENTE

100-240V ~ 50-60 Hz / 2.2 kg/4.85 lb



IP54

DRIVER

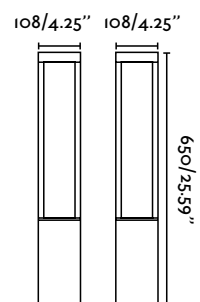



jaiPur

beacon

70758



dark grey
gris oscuro

COB LED 6W 3000K 420LM INCL. DRIVER INCL.
DIE CAST ALUMINIUM+TRANSPARENT GLASS/
ALUMINIO INYECTADO+CRISTAL TRANSPARENTE

A+ / 100-240V ~ 50-60 Hz / 0.8 kg/1.76 lb



IP54

DRIVER

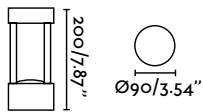

jaiPur

beacon

70759



dark grey
gris oscuro

HF

COB LED 6W 3000K 420LM INCL. DRIVER INCL.
DIE CAST ALUMINIUM+TRANSPARENT GLASS/
ALUMINIO INYECTADO+CRISTAL TRANSPARENTE

A+ / 100-240V ~ 50-60 Hz / 1.8 kg/3.97 lb



IP54

DRIVER

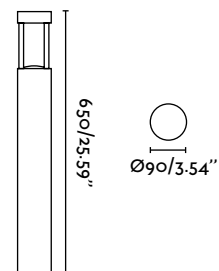

HF Until stock exhaustion
Hasta final de stock
Jusqu'à la fin de stock



seTe

beacon

7552I

● dark grey
gris oscuro

SMD LED 6W 3000K 155LM INCL. DRIVER INCL.
DIE CAST ALUMINIUM+OPAL POLYCARBONATE/
ALUMINIO INYECTADO+POLICARBONATO OPAL

A++ to A / 100-240V ~ 50-60 Hz / 1.7 kg/3.75 lb

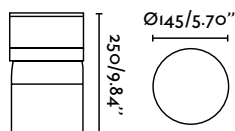
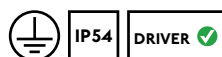

suRat

beacon

72310

● dark grey
gris oscuro

1XE27 20W NOT INCL. [16467] [LED 17059]
DIE CAST ALUMINIUM+STRIPED GLASS/
ALUMINIO INYECTADO+CRISTAL RALLADO
A++ to B / 100-240V ~ 50-60 Hz / 2.7 kg/5.95 lb

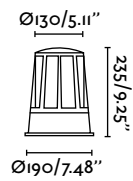

soRa

beacon

72299

● dark grey
gris oscuro

1XE27 MAX 26W NOT INCL. [16464] [LED 17059]
DIE CAST ALUMINIUM+OPAL POLYCARBONATE/
ALUMINIO INYECTADO+POLICARBONATO OPAL
A++ to B / 100-240V ~ 50-60 Hz / 3.08 kg/6.79 lb

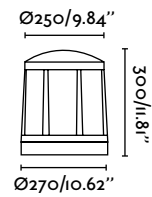



IP65

aRisto

beacon

73196

black negro

1 XG24d-3 26W NOT INCL. [15905] GEAR INCL.

DIE CAST ALUMINIUM+TRANSPARENT POLYCARBONATE/
ALUMINIO INYECTADO+POLICARBONATO TRANSPARENTE

A++ to B / 220-240V ~ 50-60 Hz / 4.28 kg/9.44 lb



IP65

Magnetic Gear

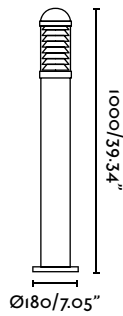

Ref. 73460



Ref. 73440



Ref. 73450

verNo

beacon

73450

black negro

73440

black negro

73460

black negro

1 XE27 MAX 60W NOT INCL. [16467] [LED 17059]

DIE CAST ALUMINIUM+TRANSPARENT POLYCARBONATE/
ALUMINIO INYECTADO+POLICARBONATO TRANSPARENTE

A+ to B / 100-240V ~ 50-60 Hz / 1.5-2-2.6 kg/3.31-4.41-5.73 lb



IP44

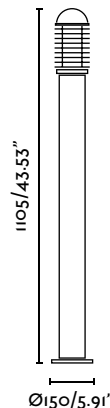

Ref. 73460

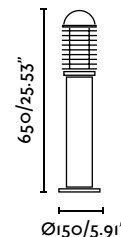



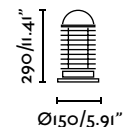























































































Ref. 73440



Ref. 73450

wall&ceiling lamps

apliques y plafones/appliques et plafonniers/lampade da parete e plafoniere

 aMon [new] 143	 feDon 175	 noNo 194
 aMura 197	 feNes 173	 noRay [new] 179
 áncora 140	 flAme 173	 oRly 191
 arGot 190	 fuTure 137	 óvAlo 197
 aSkot 197	 grAnt [new] 165	 pApo 153
 bAco [new] 161	 gRid 170	 parMa 191
 bliNd 146	 hePta 198	 piStón 150
 bOnn 171	 heRm 167	 pRoa 139
 caBo [new] 179	 iNari [new] 160	 radHa [new] 145
 canOn 149	 ioN 155	 rAdio 199
 capRi 153	 jOy 145	 rOndo 196
 cEla 177	 kaMaL 158	 rusTic 181
 cEres 183	 kAmi [new] 154	 seNa 159
 coAl 167	 keenAn 163	 seTo 189
 coBo [new] 150	 kuBick 170	 sOr 173
 coDe 138	 lAce 147	 spOt 199
 craTa 149	 lacRe 151	 sTeel 177
 cripTa 192	 latiNa 151	 sUma 168
 daDo 191	 lEva 165	 tAne 150
 dakRon 187	 linG 147	 tAsa 185
 dAkYu 187	 maRat 157	 tEjo 169
 dElta 170	 mAre 145	 tErra 193
 derBy 193	 mAya 177	 tiNia [new] 153
 diDot 151	 miRto 195	 vieNa 189
 doRval 175	 mOL 169	 viEw [new] 136
 dragMa 141	 naOmi [new] 161	 viSnu [new] 181
 driZa 188	 naTron 169	 wAlly 189
 eLe [new] 142	 neFtis [new] 155	 wEst 171
 eRio 167	 neGus 175	 yEn 186
 esTay 195	 nisHa [new] 161	 yuCa 187



WALL & CEILING LAMPING LAMPS

wall & ceiling lamps
aplüques y plafones
appliques et plafonniers
lampade da parete e plafoniere



viEw [new]

by Estudi Ribaudí

View is a wall lamp with futuristic shapes that perfectly combines innovation and reality. High resistance to atmospheric conditions.

View es un aplique con formas futuristas que combina a la perfección innovación y realidad. Alta resistencia a las condiciones atmosféricas.

View est un applique avec une forme futuriste qui combine à la perfection innovation et réalité. Elle possède une haute résistance aux conditions atmosphériques.



[new] wall lamp+wall washer

71519

● dark grey
gris oscuro

1XE27 MAX 15W NOT INCL. [16467] [LED17455]

POLYCARBONATE+ABS/
POLICARBONATO+ABS

A++ to B / 100-240V ~ 50 Hz / 0.44 kg/0.97 lb

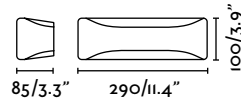

fuTure

by Estudi Ribaudi

Futures is an outdoor fixture characterised by an attractive and decorative set of indirect lights. Its smooth, flat oblong shape blend into its surroundings.

Future es un aplique para exteriores que se caracteriza por un atractivo y decorativo juego de luz indirecta. Su forma suave y apaisada genera un efecto mimético con su entorno.

Future est une applique extérieure caractérisée par un jeu de lumière indirecte esthétique et décoratif. Sa forme douce et oblongue crée un effet de mimétisme avec son environnement.



wall lamp+wall washer

71516

white
blanco

71517

dark grey
gris oscuro

1 X E27 20W NOT INCL. [16467] [LED I7455]

POLYCARBONATE/
POLICARBONATO

A++ to B / 100-240V ~ 50-60 Hz / 0.6 kg/1.32 lb

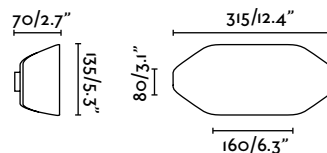

coDe

by Estudi Ribaudí

CODE is an eclipse of light, a path of concentric circles that accompany us almost unnoticed.

CODE es un eclipse de luz, un camino de círculos concéntricos que nos acompañan de una forma casi imperceptible.

CODE est une éclipse de lumière, un chemin de cercles concentriques qui nous accompagnent de manière presque imperceptible.



wall lamp

- 71526  white
blanco + 
- 71527  dark grey
gris oscuro + 

3 stickers ✓

SMD LED 2W 4000K 150LM INCL. DRIVER INCL.

POLYCARBONATE/
POLICARBONATO

A++ to A / 220-240V ~ 50-60 Hz / 0.2 kg/0.44 lb

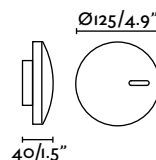

pRoa

by Manel Llusçà

A modern, compact design in die casting aluminium for a wall fixture intended for signposting. Also available in LED version.

Un diseño moderno y compacto realizado en aluminio inyectado para un aplique de pared destinado a la señalética. Disponible también en versión LED.

Un design moderne et compact en fonte d'aluminium pour une applique murale destinée à la signalétique. Également disponible en LED.



wall lamp+wall washer

LED

74399

dark grey
gris oscuro

COB LED 6W 3000K 500LM INCL. DRIVER INCL.
DIE CAST ALUMINIUM+TRANSPARENT GLASS/
ALUMINIO INYECTADO+CRISTAL TRANSPARENTE

A++ to A / 220-240V ~ 50-60 Hz / 0.7 kg/1.54 lb



IP44

DRIVER ✓



74400

dark grey
gris oscuro

1 XGU 10 MAX 35W NOT INCL. [LED 14141]
DIE CAST ALUMINIUM+TRANSPARENT GLASS/
ALUMINIO INYECTADO+CRISTAL TRANSPARENTE

A++ to E / 100-240V ~ 50-60 Hz / 0.65 kg/1.43 lb



IP44

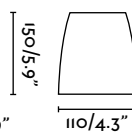

wall & ceiling lamps
apliques y plafones
appliques et plafonniers
lampade da parete e plafoniere

áncora

by Manel Lluscà

A die casting aluminium structure protects the light source, emitting indirect light up and downwards and bathing the surface on which it is fitted.

Una estructura realizada en aluminio inyectado resguarda la fuente lumínica. Emitiendo luz indirecta arriba y abajo y bañando la superficie sobre la que está ubicado.

Une structure en fonte D'aluminium protège la source lumineuse qui émet une lumière indirecte à la fois vers le haut et vers le bas et éclaire toute la surface sur laquelle elle se trouve.



UP & DOWN
ARRIBA Y ABAJO

wall lamp

74401

dark grey
gris oscuro

1 X E27 20W NOT INCL. [16467] [LED 17455]

DIE CAST ALUMINIUM+OPAL POLYCARBONATE/
ALUMINIO INYECTADO+POLICARBONATO OPAL

A++ to B / 100-240V ~ 50-60 Hz / 0.87kg/1.92 lb



110/4.3"

264/10.3"

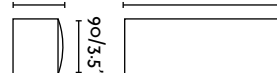

dragMa

by Manel Lluscà

Uncluttered and functional. This is DRAGMA, a wall fixture that integrates into the space thanks to its versatility: can direct light upwards, downwards or both at once.

Sobrio y funcional. Así es DRAGMA, un aplique de pared que se integra en el espacio gracias a su versatilidad: puede iluminar arriba, abajo o a ambos lados a la vez.

Sobre et fonctionnelle. DRAGMA, une applique murale qui s'intègre à l'espace grâce à sa polyvalence : elle peut éclairer vers le haut et le bas ou vers la gauche et la droite en même temps.



IP65

UP & DOWN
ARRIBA Y ABAJO

wall lamp

71362



dark grey
gris oscuro

1XG24q-2 18W 4000K INCL. ELECTRONIC GEAR INCL.

DIE CAST ALUMINIUM+TRANSLUCENT GLASS/
ALUMINIO INYECTADO+CRISTAL TRANSLÚCIDO

A to B / 220-240V ~ 50-60 Hz / 1.69 kg/3.73 lb



IP65

BALLAST



105/4.1"

90/3.5"

250/9.8"

wall & ceiling lamps
apliques y plafones
appliques et plafonniers
lampe de parete e plafoniere



[new] **eLe**
wall lamp

74419



dark grey
gris oscuro

SMD LED 6W 3000K 450LM CRI>80 INCL. DRIVER INCL.

ALUMINIUM+POLYCARBONATE/
ALUMINIO+POLICARBONATO

A+ / 220-240V ~ 50-60 Hz / 0.65 kg/1.43 lb

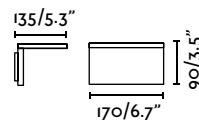

[new] **aMon-1**

wall lamp

70577



COB LED 9W 3000K 330LM CRI>80 INCL. DRIVER INCL.
DIE CAST ALUMINIUM+TRANSLUCENT GLASS/
ALUMINIO INYECTADO+DIFUSOR DE CRISTAL TRANSLÚCIDO

A / 100-240V ~ 50-60 Hz / 0.57 kg/1.26 lb

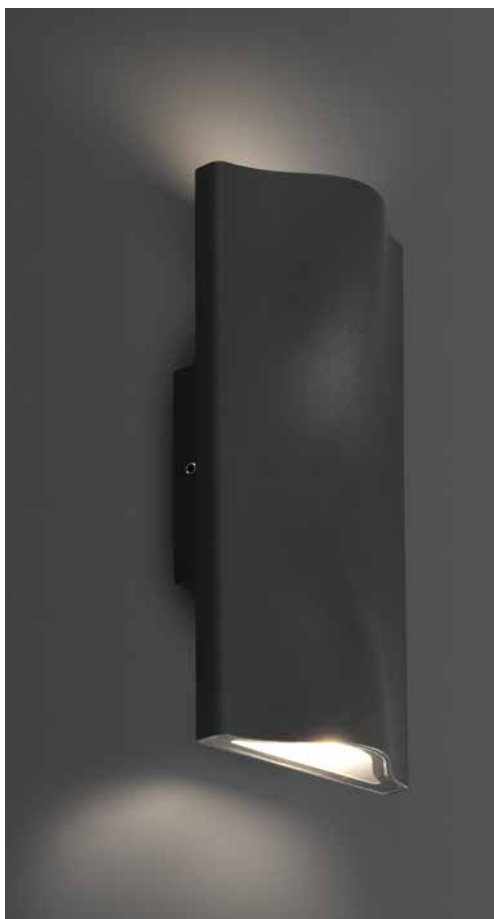
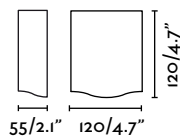

UP & DOWN
ARRIBA Y ABAJO

[new] **aMon-2**

wall lamp

70578



COB LED 18W 3000K 660LM CRI>80 INCL. DRIVER INCL.

DIE CAST ALUMINIUM+TRANSLUCENT GLASS/
ALUMINIO INYECTADO+CRISTAL TRANSLÚCIDO

A / 100-240V ~ 50-60 Hz / 1.12 kg/2.47 lb

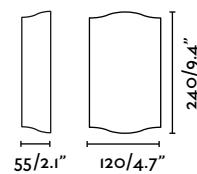

wall & ceiling lamps
aplúques y plafones
appliques et plafonniers
lampade da parete e plafoniere



[new] **radHa**

wall lamp

70816



SMD LED 6W 3000K 310LM CRI>80 INCL. DRIVER INCL.

ALUMINIUM+TEMPERED GLASS/
ALUMINIO+CRISTAL TEMPLADO

A++ to A / 220-240V ~ 50-60 Hz / 1.15 kg/2.54 lb

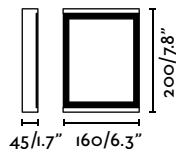

mAre

wall lamp

70635



COB LED 3W 3000K 300LM INCL. DRIVER INCL.
DIE CAST ALUMINIUM+TRANSPARENT GLASS/
ALUMINIO INYECTADO+CRISTAL TRANSPARENTE

A++ / 220-240V ~ 50-60 Hz / 2.19 kg/4.83 lb

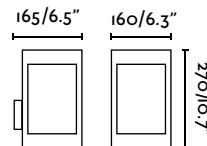
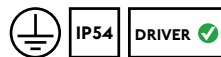

jOy

wall lamp

70814



HF

70815

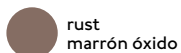

HF

SMD LED 6W 4000K 70LM INCL. DRIVER INCL.

ALUMINIUM+OPAL POLYCARBONATE/
ALUMINIO+POLICARBONATO OPAL

A++ to A / 220-240V ~ 50-60 Hz / 0.83 kg/1.83 lb

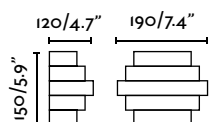

HF

Until stock exhaustion
Hasta final de stock
Jusqu'à la fin de stock

wall & ceiling lamps
aplúques y plafones
appliques et plafonniers
lampade da parete e plafoniere



UP & DOWN
ARRIBA Y ABAJO

blIND

wall lamp

70634

dark grey
gris oscuro

HIGH POWER LED 2X3W 3000K 600LM INCL. DRIVER INCL.

DIE CAST ALUMINIUM+TRANSPARENT GLASS/
ALUMINIO INYECTADO+CRISTAL TRANSPARENTE

A++ / 110-240V ~ 50-60 Hz / 1.07 kg/2.36 lb



Swivel flaps
Aletas direccionables

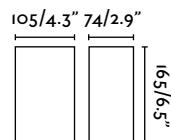

UP & DOWN
ARRIBA Y ABAJO

linG

wall lamp

70812  dark grey
gris oscuro

70813  white
blanco

HIGH POWER LED 2X3W 4000K 315 LM INCL. DRIVER INCL.

DIE CAST ALUMINIUM+TRANSPARENT GLASS/
ALUMINIO INYECTADO+CRISTAL TRANSPARENTE

A++ to A / 220-240V ~ 50-60 Hz / 1.1 kg/2.43 lb

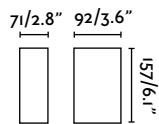

UP & DOWN
ARRIBA Y ABAJO

lAce

wall lamp

70811  dark grey
gris oscuro

HIGH POWER LED 2X3W 4000K 315LM INCL. DRIVER INCL.

DIE CAST ALUMINIUM+TRANSPARENT GLASS/
ALUMINIO INYECTADO+CRISTAL TRANSPARENTE

A++ to A / 110-240V ~ 50-60 Hz / 0.91 kg/2.01 lb

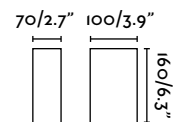

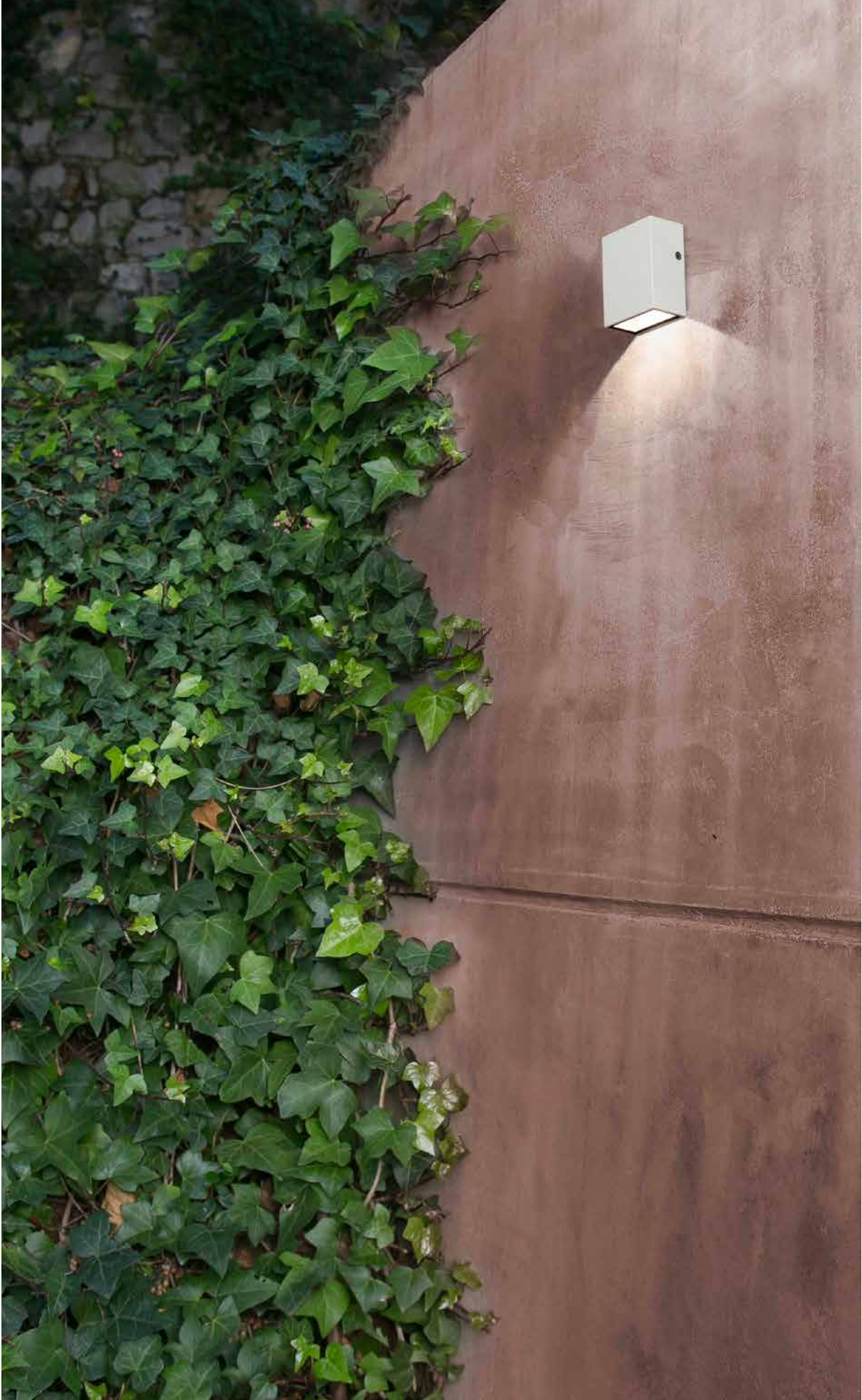

canOn

wall lamp

- 70566  dark grey / gris oscuro 4000K HF
- 70567  white / blanco 4000K HF
- [new] 70566N  dark grey / gris oscuro 3000K
- [new] 70567N  white / blanco 3000K

HIGH POWER LED 4W I30LM INCL. DRIVER INCL.
 DIE CAST ALUMINIUM+TEMPERED GLASS/
 ALUMINIO INYECTADO+CRISTAL TEMPLADO
 A++ to A / 220-240V ~ 50-60 Hz / 0.3 kg/0.66 lb



HF

Until stock exhaustion
 Hasta final de stock
 Jusqu'à la fin de stock

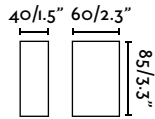

UP & DOWN
 ARRIBA Y ABAJO

craTa

wall lamp

- 70568  dark grey / gris oscuro
- 70569  white / blanco

HIGH POWER LED 2X3W 4000K I30LM INCL. DRIVER INCL.
 DIE CAST ALUMINIUM+TEMPERED GLASS/
 ALUMINIO INYECTADO+CRISTAL TEMPLADO
 A++ to A / 220-240V ~ 50-60 Hz / 0.66 kg/1.46 lb

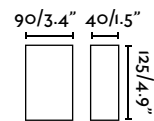

UP & DOWN
ARRIBA Y ABAJO

tAne

wall lamp

72269

dark grey
gris oscuro

SMD LED 2X3W 3000K 400LM INCL. DRIVER INCL.

ALUMINIUM+TRANSLUCENT GLASS/
ALUMINIO+CRISTAL TRANSLÚCIDO

A++ / 220-240V ~ 50-60 Hz / 0.8 kg/1.76 lb

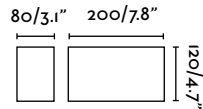

UP & DOWN
ARRIBA Y ABAJO

piStón

wall lamp

70808

grey
gris

2XGU 10 MAX 50W NOT INCL. [LED 14141]

DIE CAST ALUMINIUM+TRANSPARENT GLASS/
ALUMINIO INYECTADO+CRISTAL TRANSPARENTE

A++ to E / 100-240V ~ 50-60 Hz / 1.14 kg/2.51 lb

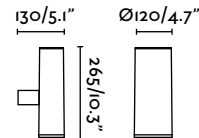
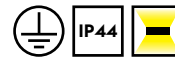

UP & DOWN
ARRIBA Y ABAJO

IP65

[new] coBo

wall lamp

70404

dark grey
gris oscuro

COB LED 12W 4000K 600LM CRI<80 INCL. DRIVER INCL.

DIE CAST ALUMINIUM+GLASS/
ALUMINIO INYECTADO+CRISTAL

A+ / 100-240V ~ 50-60 Hz / 1.79 kg/3.95 lb

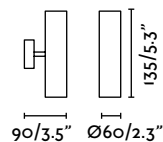

IP65

UP & DOWN
ARRIBA Y ABAJO

latiNa

wall lamp

70694



dark grey
gris oscuro

I XG24d-3 26W NOT INCL. [I5905] GEAR INCL
ALUMINIUM+TRANSLUCENT GLASS/
ALUMINIO+CRISTAL TRANSLÚCIDO
A++ to B / 220-240V ~ 50-60 Hz / 1.79 kg/3.95 lb

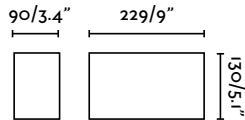

UP & DOWN
ARRIBA Y ABAJO

diDot

wall lamp

71368



grey
gris

71369



black
negro

I XR7S JP78 MAX 100W INCL.
ALUMINIUM+TRANSLUCENT GLASS/
ALUMINIO+CRISTAL TRANSLÚCIDO
A++ to D / 220-240V ~ 50-60 Hz / 0.8 kg/1.76 lb

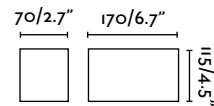
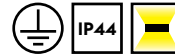

UP & DOWN
ARRIBA Y ABAJO

lacRe

wall lamp

70802



dark grey
gris oscuro

70803



grey
gris

I XE27 MAX 100W NOT INCL. [I6592] [LED I7453]
DIE CAST ALUMINIUM+TRANSPARENT GLASS/
ALUMINIO INYECTADO+CRISTAL TRANSPARENTE
A++ to E / 100-240V ~ 50-60 Hz / 1.02 kg/2.25 lb

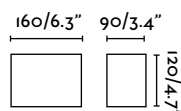

wall & ceiling lamps
aplúques y plafones
appliques et plafonniers
lampade da parete e plafoniere



[new] **tiNia**

wall lamp

71353



I XE27 MAX 60W NOT INCL. [16467] [LED I7059]

ALUMINIUM+POLYCARBONATE/
ALUMINIO+POLICARBONATO

A++ to E / 100-240V ~ 50-60 Hz / 0.57 kg/1.26 lb

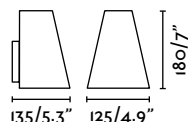

capRi

wall lamp

70565



I XE27 15W NOT INCL. [16466] [LED I7455]

DIE CAST ALUMINIUM+TEMPERED GLASS/
ALUMINIO INYECTADO+CRISTAL TEMPLADO

A++ to B / 100-240V ~ 50-60 Hz / 2.3 kg/5.07 lb

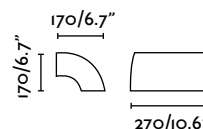

UP & DOWN
ARRIBA Y ABAJO

pApo

wall lamp

72267



LED 4W 4000K 200LM INCL. DRIVER INCL.

ALUMINIUM+TRANSLUCENT GLASS/
ALUMINIO+CRISTAL TRANSLÚCIDO

A++ to A / 220-240V ~ 50-60 Hz / 0.6 kg/1.32 lb

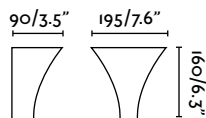

wall & ceiling lamps
aplúques y plafones
appliques et plafonniers
lampade da parete e plafoniere



INOX 316

UP & DOWN
ARRIBA Y ABAJO

[new] **kAmi**
wall lamp

72283

● matt nickel+white
níquel mate+blanco

HIGH POWER LED 6W 3000K 140 LM INCL. DRIVER INCL.

316 STAINLESS INOX+POLYCARBONATE/
ACERO INOXIDABLE 316+POLICARBONATO

A++ / 100-240V ~ 50-60 Hz / 0.44 kg/0.97 lb

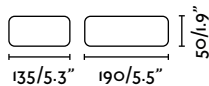

UP & DOWN
ARRIBA Y ABAJO

INOX 316

[new] **neFtis**
wall lamp

72284

● matt níquel
níquel mate

SMD LED 7W 3000K 360LM INCL. DRIVER INCL.
316 STAINLESS INOX+POLYCARBONATE/
ACERO INOXIDABLE 316+POLICARBONATO
A++ / 100-240V ~ 50-60 Hz / 0.51 kg/1.12 lb

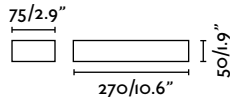

INOX

ioN-1
wall lamp

71384

● matt níquel
níquel mate

1 XGX53 9W NOT INCL. [14041]
STAINLESS STEEL+TRANSPARENT GLASS/
ACERO INOXIDABLE+CRISTAL TRANSPARENTE
A++ to B / 100-240V ~ 50-60 Hz / 0.43 kg/0.95 lb

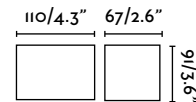

UP & DOWN
ARRIBA Y ABAJO

INOX

ioN-2
wall lamp

71385

● matt níquel
níquel mate

2 XGX53 9W NOT INCL. [14041]
STAINLESS STEEL+TRANSPARENT GLASS/
ACERO INOXIDABLE+CRISTAL TRANSPARENTE
A++ to B / 100-240V ~ 50-60 Hz / 0.43 kg/0.95 lb

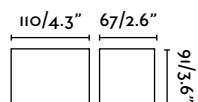

wall & ceiling lamps
aplúques y plafones
appliques et plafonniers
lampade da parete e plafoniere



maRat-1

wall lamp

70551



dark grey
gris oscuro

HIGH POWER LED 2W 3000K 150LM INCL. DRIVER INCL.

DIE CAST ALUMINIUM+TRANSPARENT GLASS/
ALUMINIO INYECTADO+CRISTAL TRANSPARENTE

A++ to A / 220-240V ~ 50-60 Hz / 0.56 kg/1.23 lb

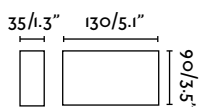

UP & DOWN
ARRIBA Y ABAJO

maRat-2

wall lamp

70552



dark grey
gris oscuro

HIGH POWER LED 4W 3000K 300LM INCL. DRIVER INCL.

DIE CAST ALUMINIUM+TRANSPARENT GLASS/
ALUMINIO INYECTADO+CRISTAL TRANSPARENTE

A++ to A / 220-240V ~ 50-60 Hz / 0.6 kg/1.32 lb

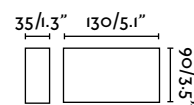



kaMal-1

wall lamp

70556



dark grey
gris oscuro

HIGH POWER LED 1W 3000K 50LM INCL. DRIVER INCL.

DIE CAST ALUMINIUM+TEMPERED GLASS/
ALUMINIO INYECTADO+CRISTAL TEMPLADO

A++ to A / 220-240V ~ 50-60 Hz / 0.33 kg/0.73 lb

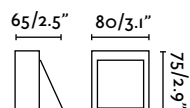

seNa-1

wall lamp

70511

dark grey
gris oscuro

SMD LED 3W 3000K 100LM INCL. DRIVER INCL.

DIE CAST ALUMINIUM+PVC/
ALUMINIO INYECTADO+PVC

A++ to A / 220-240V ~ 50-60 Hz / 0.2 kg/0.44 lb

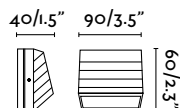

seNa-2

wall lamp

70512

dark grey
gris oscuro

SMD LED 4W 3000K 150LM INCL. DRIVER INCL.

DIE CAST ALUMINIUM+PVC/
ALUMINIO INYECTADO+PVC

A++ to A / 220-240V ~ 50-60 Hz / 0.32 kg/0.71 lb

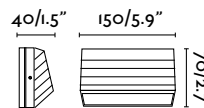

UP & DOWN
ARRIBA Y ABAJO

kaMaI-2

wall lamp

70560

dark grey
gris oscuro

HIGH POWER LED 2X1W 3000K 110LM INCL. DRIVER INCL.

DIE CAST ALUMINIUM+TEMPERED TRANSPARENT GLASS/
ALUMINIO INYECTADO+CRISTAL TEMPLADO TRANSPARENTE

A+ / 220-240V ~ 50-60 Hz / 0.5 kg/1.10 lb

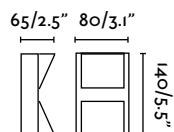

wall & ceiling lamps
apliques y plafones
appliques et plafonniers
lampe de parete e plafoniere



ORIENTABLE

[new] **iNari**

wall lamp

70820

● dark grey
gris oscuro

SMD LED 9W 3000K 230LM CRI>80 INCL. DRIVER INCL

ALUMINIUM+OPAL POLYCARBONATE/
ALUMINIO+ POLICARBONATO OPAL

A++ to A / 100-240V ~ 50-60 Hz / 0.74 kg/1.63 lb

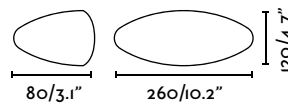

3 POSITIONS: WALL LAMP, CEILING, POST LAMP
3 POSICIONES: APLIQUE, PLAFON, SOBREMURO

[new] naOmi

wall lamp

70636



dark grey
gris oscuro

COB LED 6W 3000K 600LM CRI>80 INCL. DRIVER INCL.

DIE CAST ALUMINIUM+OPAL POLYCARBONATE/
ALUMINIO INYECTADO+POLICARBONATO OPAL

A / 220-240V ~ 50-60 Hz / 1.45 kg/3.20 lb

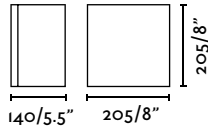

[new] nisHa

wall lamp

70817



dark grey
gris oscuro

SMD LED 6W 4000K 560 LM CRI>80 INCL. DRIVER INCL.

ALUMINIUM+OPAL POLYCARBONATE/
ALUMINIO+POLICARBONATO OPAL

A++ to A / 100-240V ~ 50-60 Hz / 0.85 kg/1.87 lb



Serigraphic not incl.
Serigrafía no incl.

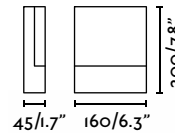

2 POSITIONS
2 POSICIONES

[new] bAco

wall lamp

70819

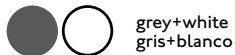

grey+white
gris+blanco

SMD LED 6W 4000K 620 LM CRI>80 INCL. DRIVER INCL.

ALUMINIUM+OPAL POLYCARBONATE/
ALUMINIO+POLICARBONATO OPAL

A++ to A / 100-240V ~ 50-60 Hz / 0.65 kg/1.43 lb

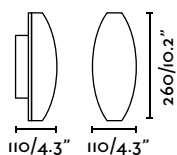



IP67

keenAn-2

surface

70546

nickel
níquel

LED 0.5W 6500K 20LM INCL.
GEAR NOT INCL. [98101050 ELT 50W]
ALUMINIUM+TRANSPARENT GLASS/
ALUMINIO+CRISTAL TRANSPARENTE
A++ to A / 12V AC / 0.1 kg/0.22 lb



Ø70/2.8"



IP67

keenAn

surface

70547

nickel
níquel

LED 0.8W 6500K 40LM INCL.
GEAR NOT INCL. [98101050 ELT 50W]
ALUMINIUM+TRANSPARENT GLASS/
ALUMINIO+CRISTAL TRANSPARENTE
A++ to A / 12V AC / 0.00 kg/0.00 lb



Ø70/2.8"



IP67

keenAn-3

surface

70564

nickel
níquel

LED 1W 6500K 80LM INCL.
GEAR NOT INCL. [98101050 ELT 50W]
ALUMINIUM+TRANSPARENT GLASS/
ALUMINIO+CRISTAL TRANSPARENTE
A++ to A / 12V AC / 0.1 kg/0.22 lb



Ø70/2.8"



T Exclusive use with magnetic transformer
Uso exclusivo transformador magnético
Utilisation exclusif avec transformateur magnétique

wall & ceiling lamps
aplúques y plafones
appliques et plafonniers
lampade da parete e plafoniere



LEva

wall lamp

70892



SMD LED 2W 4000K 50LM INCL. DRIVER INCL.
DIE CAST ALUMINIUM+TRANSPARENT GLASS/
ALUMINIO INYECTADO+CRISTAL TRANSPARENTE
A++ to A / 220-240V ~ 50-60 Hz / 0.39 kg/0.86 lb

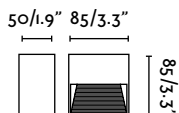

IP65

[new] grAnt wall lamp

70655



SMD LED 1W 3000K 65 LM CRI<80 INCL. DRIVER INCL.
ABS+POLYCARBONATE/
ABS+POLICARBONATO
A++ / 100-240V ~ 50-60 Hz / 0.20 kg/0.44 lb

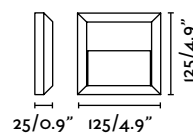

IP65

[new] grAnt wall lamp

70656



SMD LED 1W 3000K 65 LM CRI<80 INCL. DRIVER INCL.
ABS+POLYCARBONATE/
ABS+POLICARBONATO
A++ / 100-240V ~ 50-60 Hz / 0.20 kg/0.44 lb

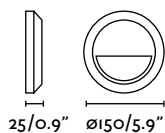



heRm-Pir

wall lamp

70624



black
negro

SMD LED 6W 6500K 480LM INCL. DRIVER INCL.

POLYCARBONATE+OPAL POLYCARBONATE/
POLICARBONATO+POLICARBONATO OPAL

A++ to A / 220-240V ~ 50-60 Hz / 0.87 kg/1.92 lb

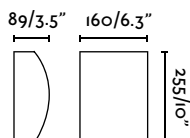

PIR



UNIQUE POSITION
UNICA POSICIÓN

eRio

wall lamp

72270



dark grey
gris oscuro

1 X E27 14W NOT INCL. [I6466] [LED I7059]

ALUMINIUM+OPAL POLYCARBONATE/
ALUMINIO+POLICARBONATO OPAL

A++ to B / 100-240V ~ 50-60 Hz / 0.87 kg/1.92 lb

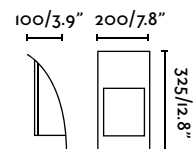

coAl

wall lamp

71365



dark grey
gris oscuro

1 X G24d-3 MAX 26W NOT INCL. [I5905] GEAR INCL.

DIE CAST ALUMINIUM+OPAL PVC/
ALUMINIO INYECTADO+PVC OPAL

A to B / 220-240V ~ 50-60 Hz / 1.27 kg/2.80 lb

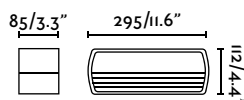
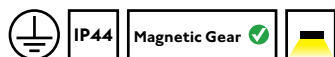

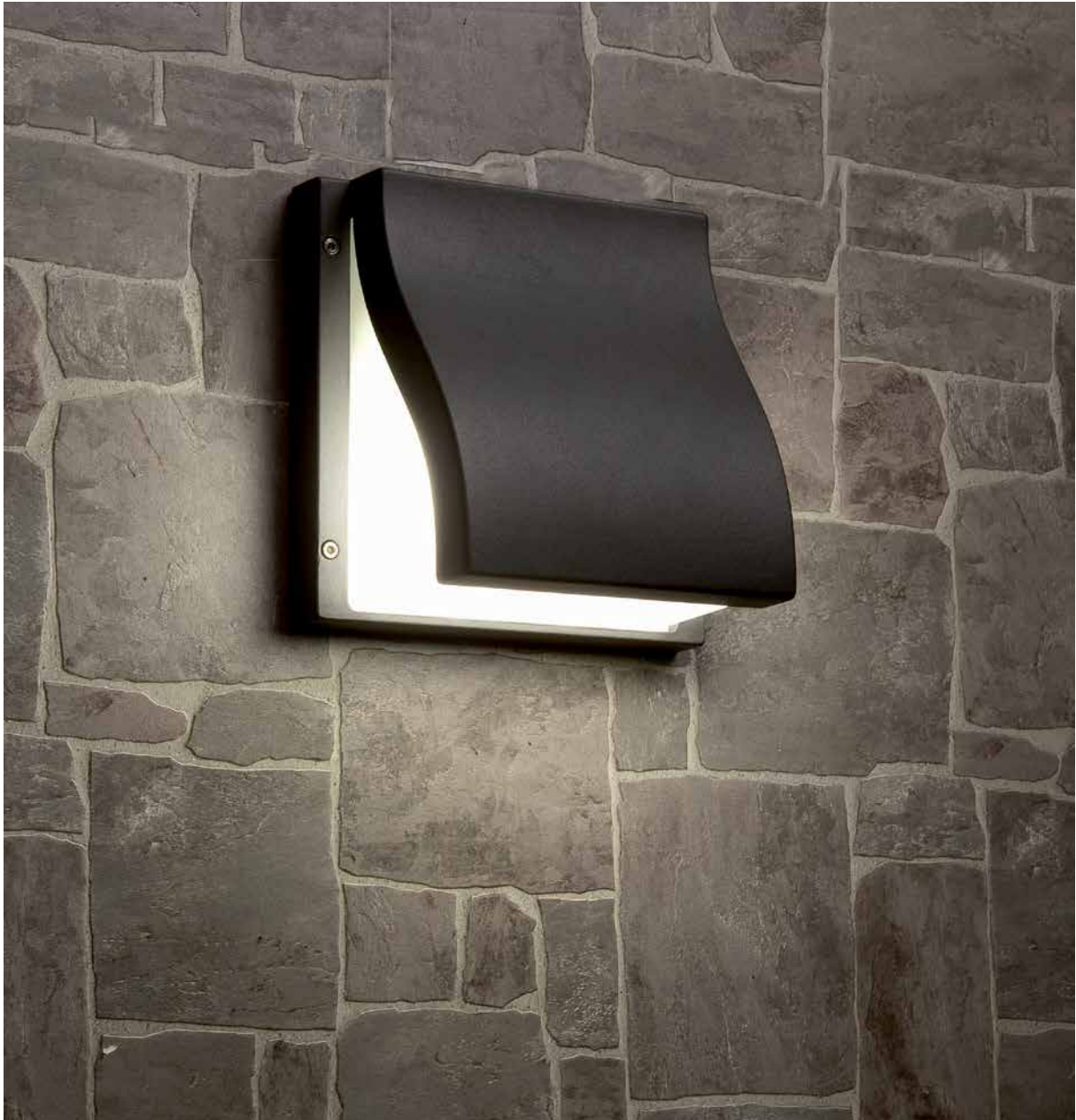

sUma

wall lamp

70749

dark grey
gris oscuro

2XE27 15W NOT INCL. [16592] [LED I7059]

DIE CAST ALUMINIUM+TRANSLUCENT GLASS/
ALUMINIO INYECTADO+CRISTAL TRANSLÚCIDO

A++ to A / 100-240V ~ 50-60 Hz / 2.9 kg/6 lb

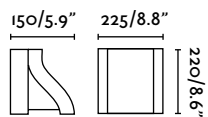

UP & DOWN
ARRIBA Y ABAJO

naTron

wall lamp

70887

dark grey
gris oscuro

1XE27 MAX 100W NOT INCL. [16467]

DIE CAST ALUMINIUM+TRANSPARENT GLASS/
ALUMINIO INYECTADO+CRISTAL TRANSPARENTE

A++ to E / 100-240V ~ 50-60 Hz / 1.39 kg/3.06 lb

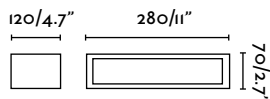

mOl

wall lamp

70720

dark grey
gris oscuro

1XE27 11W NOT INCL. [16620]

DIE CAST ALUMINIUM+OPAL POLYCARBONATE/
ALUMINIO INYECTADO+POLICARBONATO OPAL

A++ to B / 100-240V ~ 50-60 Hz / 0.89 kg/1.96 lb

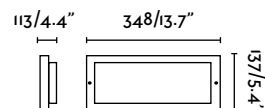

UP & DOWN
ARRIBA Y ABAJO

tEjo

wall lamp

70573

dark grey
gris oscuro

1XE27 20W NOT INCL. [16466]

DIE CAST ALUMINIUM+OPAL POLYCARBONATE
ALUMINIO INYECTADO+POLICARBONATO OPAL

A++ to B / 100-240V ~ 50-60 Hz / 1.1 kg/2.43 lb

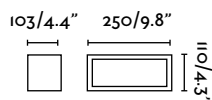

wall & ceiling lamps
aplúques y plafones
appliques et plafonniers
lampade da parete e plafoniere

kuBick

wall lamp

70689  dark grey
gris oscuro

70715  grey
gris

1 X E27 MAX 60W NOT INCL. [16466]

DIE CAST ALUMINIUM+OPAL PVC/
ALUMINIO INYECTADO+PVC OPAL

A++ to E / 100-240V ~ 50-60 Hz / 1.21 kg/2.67 lb

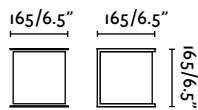

gRid

wall lamp

70717  dark grey
gris oscuro

1 X E27 15W NOT INCL. [16592]

ALUMINIUM+TRANSLUCENT GLASS/
ALUMINIO+CRISTAL TRANSLÚCIDO

A++ to B / 100-240V ~ 50-60 Hz / 0.93 kg/2.05 lb

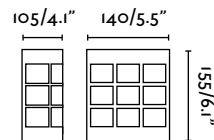

dElta

wall lamp

70700  dark grey
gris oscuro

1 X E27 MAX 75W NOT INCL. [16466]

DIE CAST ALUMINIUM+TRANSPARENT PVC/
ALUMINIO INYECTADO+PVC TRANSPARENTE

A++ to E / 100-240V ~ 50-60 Hz / 1.6 kg/3.53 lb

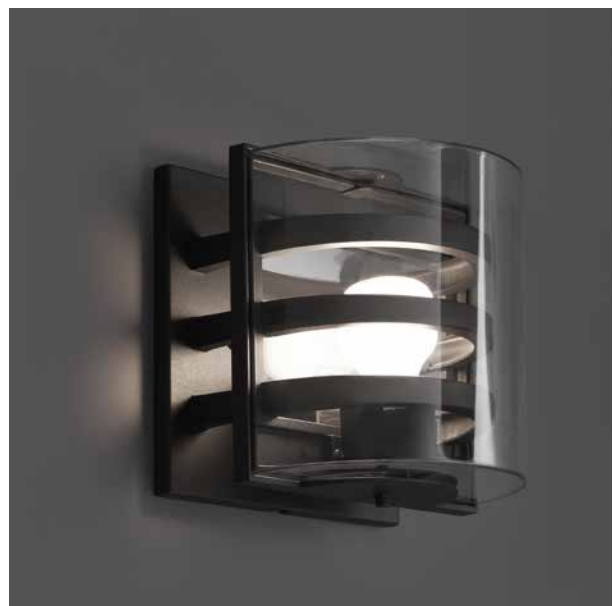
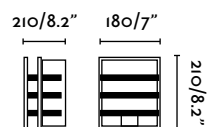



wEst-1

wall lamp

70888

● dark grey
gris oscuro

1 XE27 MAX 100W NOT INCL. [16466]

DIE CAST ALUMINIUM+TRANSLUCENT GLASS/
ALUMINIO INYECTADO+CRISTAL TRANSLÚCIDO

A++ to E / 100-240V ~ 50-60 Hz / 0.05 kg/0.11 lb

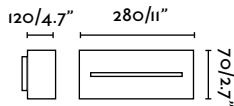

wEst-2

wall lamp

70899

● dark grey
gris oscuro

1 XE27 MAX 100W NOT INCL. [16466]

DIE CAST ALUMINIUM+TRANSLUCENT GLASS/
ALUMINIO INYECTADO+CRISTAL TRANSLÚCIDO

A++ to E / 100-240V ~ 50-60 Hz / 1.18 kg/2.60 lb

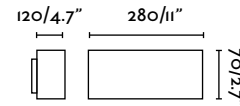
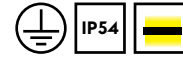

bOnn-1

wall lamp

70702

● dark grey
gris oscuro

1 XG24d-3 26W NOT INCL. [15905] GEAR INCL.

DIE CAST ALUMINIUM+TRANSLUCENT PVC/
ALUMINIO INYECTADO+PVC TRANSLÚCIDO

A++ to B / 220-240V ~ 50-60 Hz / 1.5 kg/3.31 lb

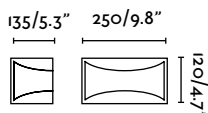

bOnn-2

wall lamp

70697

● dark grey
gris oscuro

1 XE27 MAX 100W NOT INCL. [16467]

DIE CAST ALUMINIUM+PVC/
ALUMINIO INYECTADO+PVC

A++ to E / 100-240V ~ 50-60 Hz / 1.1 kg/2.43 lb

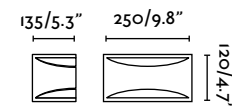



sOr

wall lamp

72265  dark grey
gris oscuro

72266  dark grey
gris oscuro

1 XE27 II W NOT INCL. [16620]

DIE CAST ALUMINIUM+OPAL POLYCARBONATE
ALUMINIO INYECTADO+POLICARBONATO OPAL

A++ to B / 100-240V ~ 50-60 Hz / 0.7-1 kg/1.54-2.20 lb

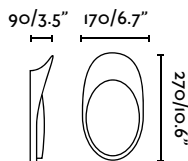

Ref. 72265

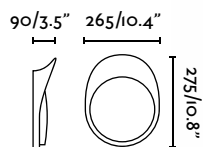

Ref. 72266



Ref. 72265

Ref. 72266



HF

Until stock exhaustion
Hasta final de stock
Jusqu'à la fin de stock

flAme

wall lamp

74420  dark grey
gris oscuro

HF

1 XE27 23W NOT INCL. [16464]

DIE CAST ALUMINIUM+OPAL PMMA/
ALUMINIO INYECTADO+PMMA OPAL

A+++ to B / 100-240V ~ 50-60 Hz / 2.2 kg/4.85 lb

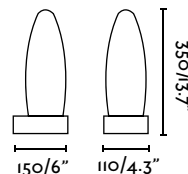

feNes-1

wall lamp

72004  dark grey
gris oscuro

1 XG24 d-3 26W NOT INCL. [15905] GEAR INCL.

DIE CAST ALUMINIUM+OPAL POLYCARBONATE/
ALUMINIO INYECTADO+POLICARBONATO OPAL

A++ to B / 220-240V ~ 50-60 Hz / 2.2 kg/4.85 lb

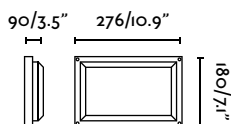

wall & ceiling lamps
aplüques y plafones
appliques et plafonniers
lampade da parete e plafoniere



UP & DOWN
ARRIBA Y ABAJO

INOX

doRval-2

wall lamp

72261



matt nickel
níquel mate

1 X E27 15W NOT INCL. [16466]

STAINLESS STEEL+OPAL POLYCARBONATE/
ACERO INOXIDABLE+POLICARBONATO OPAL

A++ to B / 100-240V ~ 50-60 Hz / 0.55 kg/1.21 lb



95/3.7"

320/12.6"

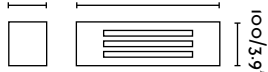

100/3.9"

UP & DOWN
ARRIBA Y ABAJO

INOX

feDon

wall lamp

70713



black
negro

70714



matt nickel
níquel mate

1 XE27 MAX 60W NOT INCL. [16467]

STAINLESS STEEL+OPAL PVC/
ACERO INOXIDABLE+PVC OPAL/

A++ to E / 100-240V ~ 50-60 Hz / 0.9 kg/1.98 lb

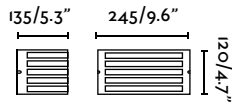

neGus

wall lamp

70696



grey
gris

1 XE27 MAX 60W NOT INCL. [16467]

DIE CAST ALUMINIUM+OPAL POLYCARBONATE/
ALUMINIO INYECTADO+POLICARBONATO OPAL

A++ to E / 100-240V ~ 50-60 Hz / 0.9 kg/1.98 lb

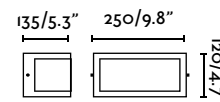
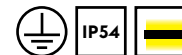

INOX

doRval-1

wall lamp

72260



matt nickel
níquel mate

1 XE27 15W NOT INCL. [16466]

STAINLESS STEEL+OPAL POLYCARBONATE/
ACERO INOXIDABLE+POLICARBONATO OPAL

A++ to B / 100-240V ~ 50-60 Hz / 0.55 kg/1.21 lb

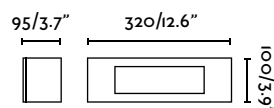

wall & ceiling lamps
aplúques y plafones
appliques et plafonniers
lampade da parete e plafoniere



INOX

cEla-2

wall lamp

72281

● matt nickel
níquel mate

I XE27 15W NOT INCL. [16466]

STAINLESS STEEL+OPAL POLYCARBONATE/
ACERO INOXIDABLE+POLICARBONATO OPAL

A++ to E / 100-240V ~ 50-60 Hz / 0.6 kg/1.32 lb



INOX

cEla-1

wall lamp

72280

 matt nickel
níquel mate

1 XE27 15W NOT INCL. [16466]

STAINLESS STEEL+OPAL POLYCARBONATE/
ACERO INOXIDABLE+POLICARBONATO OPAL

A++ to E / 100-240V ~ 50-60 Hz / 0.6 kg/1.32 lb

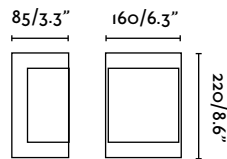

INOX

mAya-1

wall lamp

72247

 matt nickel
níquel mate

1 XE27 15W NOT INCL. [16466]

STAINLESS STEEL+OPAL POLYCARBONATE/
ACERO INOXIDABLE+POLICARBONATO OPAL

A++ to E / 100-240V ~ 50-60 Hz / 0.49 kg/1.08 lb

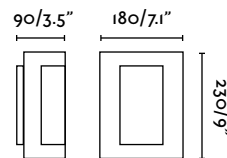

INOX

sSteel-2

wall lamp

72236

 matt nickel
níquel mate

1 XE27 60W NOT INCL. [16466]

STAINLESS STEEL+OPAL POLYCARBONATE/
ACERO INOXIDABLE+POLICARBONATO OPAL

A++ to E / 100-240V ~ 50-60 Hz / 0.85 kg/1.87 lb

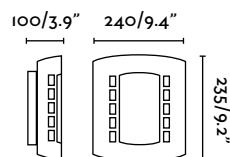

wall & ceiling lamps
aplúques y plafones
appliqués et plafonniers
lampade da parete e plafoniere





IP65

[new] **noRay**
wall lamp

70999

brass
latón

1 X E27 15W NOT INCL. [16468] [LED I7455]

BRASS+STRIPED GLASS/
LATÓN+CRISTAL RALLADO

A++ to E / 100-240V ~ 50-60 Hz / 1.52 kg/3.35 lb

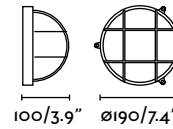

IP65

[new] **caBo**
wall lamp

70998

brass
latón

1 X E27 20W NOT INCL. [16468] [LED I7455]

BRASS+STRIPED GLASS/
LATÓN+CRISTAL RALLADO

A++ to E / 100-240V ~ 50-60 Hz / 1.52 kg/3.35 lb

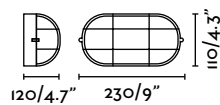





LED

[new] **viSnu**
wall lamp

70818  dark grey
gris oscuro

SMD LED 9W 4000K 700 LM CRI >80 INCL. DRIVER INCL.

ALUMINIUM+OPAL POLYCARBONATE/
ALUMINIO+POLICARBONATO OPAL

A++ to A / 100-240V ~ 50-60 Hz / 1.21 kg/2.67 lb

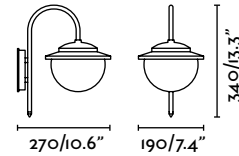

rustic
wall lamp

71147  brown
marrón

1 XE27 60W NOT INCL. [16622]

METAL+TRANSPARENT GLASS/
METAL+CRISTAL TRANSPARENTE

A++ to E / 100-240V ~ 50-60 Hz / 1.1 kg/2.43 lb

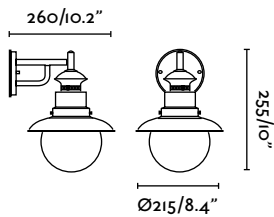





cEres

by Manel Lluscà

wall lamp

71607



black
negro

1XE27 20W NOT INCL. [I6466]

OPAL POLYCARBONATE+TRANSPARENT GLASS/
POLICARBONATO OPAL+CRISTAL TRANSPARENTE

A++ to A / 100-240V ~ 50-60 Hz / 2 kg/4.40 lb

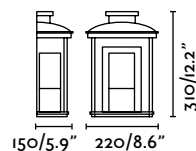

cEres

by Manel Lluscà

wall lamp

71608

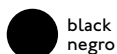

black
negro

2XE27 20W NOT INCL. [I6466]

OPAL POLYCARBONATE+TRANSPARENT GLASS/
POLICARBONATO OPAL+CRISTAL TRANSPARENTE

A++ to A / 100-240V ~ 50-60 Hz / 2.9 kg/6.39 lb

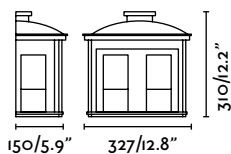





tAsa

ceiling lamp

70806

● dark grey
gris oscuro

1 X PAR30 MAX 75W NOT INCL.

DIE CAST ALUMINIUM+TEMPERED GLASS/
ALUMINIO INYECTADO+CRISTAL TEMPLADO

A++ to E / 100-240V ~ 50-60 Hz / 0.73 kg/1.61 lb

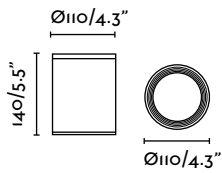

tAsa-2

ceiling lamp

70574

● dark grey
gris oscuro

1 X E27 15W NOT INCL. [LED I7059]

DIE CAST ALUMINIUM+TEMPERED GLASS/
ALUMINIO INYECTADO+CRISTAL TEMPLADO

A++ to B / 100-240V ~ 50-60 Hz / 0.9 kg/1.98 lb

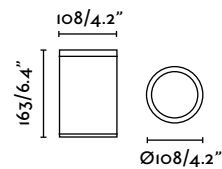



yEn

ceiling lamp

70690



1 X E27 MAX 60W NOT INCL. [I6467]

DIE CAST ALUMINIUM+OPAL POLYCARBONATE/
ALUMINIO INYECTADO+POLICARBONATO OPAL

A++ to E / 100-240V ~ 50-60 Hz / 1.24 kg/2.73 lb

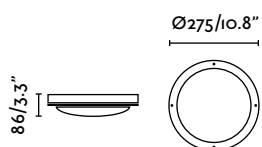

IP65

dakRon

ceiling lamp

70722



1XE27 MAX 40W NOT INCL. [16467]

ABS+OPAL POLYCARBONATE/
ABS+POLICARBONATO OPAL

A++ to E / 100-240V ~ 50-60 Hz / 0.92 kg/2.03 lb

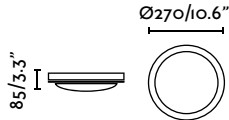

LED

yuCa

ceiling lamp

63401



SMD LED II W 4000K 635LM INCL. DRIVER INCL.

ALUMINIUM+OPAL GLASS/
ALUMINIO+CRISTAL OPAL

A++ to A / 220-240V ~ 50-60 Hz / 1.4 kg/3.09 lb

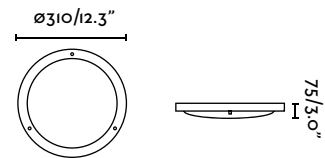
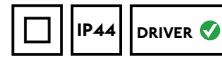

IP66

dAkyu

ceiling lamp

70719



2XE27 40W NOT INCL. [16466]

ABS+OPAL POLYCARBONATE/
ABS+POLICARBONATO OPAL

A++ to E / 100-240V ~ 50-60 Hz / 1.5 kg/3.31 lb



IP65

PIR

LED

70723



SMD LED 20W 3000K 1500LM INCL. DRIVER INCL.

ABS+OPAL POLYCARBONATE/
ABS+POLICARBONATO OPAL

A++ to A / 220-240V ~ 50-60 Hz / 1.6 kg/3.53 lb

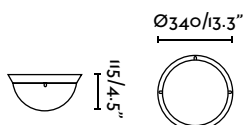

wall & ceiling lamps
aplüques y plafones
appliques et plafonniers
lampade da parete e plafoniere



driZa

wall lamp

71148

● matt nickel
níquel mate

1 X E27 MAX 60W NOT INCL. [I6620] [LED I7059]

STAINLESS STEEL+TRANSPARENT PVC/
ACERO INOXIDABLE+PVC TRANSPARENTE

A++ to E / 100-240V ~ 50-60 Hz / 2 kg/4.4l lb

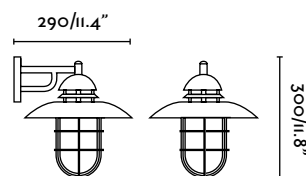

wAlly

wall lamp

74261

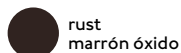

rust
marrón óxido

1 XE27 15W INCL. [16466]

METAL+TRANSPARENT GLASS/
METAL+CRISTAL TRANSPARENTE

A+ to B / 220-240V ~ 50-60 Hz / 1.59 kg/3.51 lb

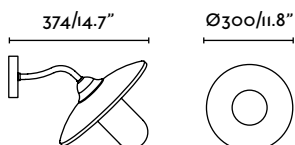

BULB INCLUDED
BOMBILLA INCLUIDA

vieNa

1/2 wall lamp

73398



black
negro

1 XE27 MAX 60W NOT INCL. [16466 13W INCL.]

DIE CAST ALUMINIUM+TRANSLUCENT GLASS/
ALUMINIO INYECTADO EPOXI+CRISTAL TRANSLÚCIDO

A+ to B / 220-240V ~ 50-60 Hz / 1.1 kg/2.43 lb

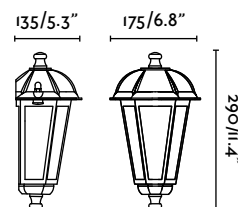

seTo

ceiling lamp

71433



rust
marrón óxido

1 XE27 MAX 60W NOT INCL. [16592]

DIE CAST ALUMINIUM+TRANSLUCENT GLASS/
ALUMINIO INYECTADO+CRISTAL TRANSLÚCIDO

A++ to E / 100-240V ~ 50-60 Hz / 1.3 kg/2.87 lb

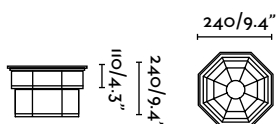



arGot

1/2 wall lamp

71424



rust
marrón óxido

1 X E27 MAX 100W NOT INCL. [I6467]

STEEL+BUBBLE GLASS/
ACERO+CRISTAL BURBUJA

A++ to E / 100-240V ~ 50-60 Hz / 1.7 kg/3.75 lb

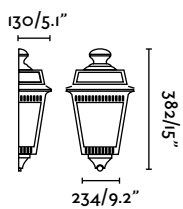



Ref. 71601



Ref. 71606

BULB INCLUDED
BOMBILLA INCLUIDA

daDo

wall lamp

- 71601**  old gold
oro envejecido
- 71605**  old gold
oro envejecido
- 71606**  brown
marrón

1 XE27 MAX 60W NOT INCL. [16466 INCL.]

METAL+BUBBLE GLASS/
METAL+CRISTAL BURBUJA

A++ to B / 220-240V ~ 50-60 Hz / 1.15 kg/2.54 lb

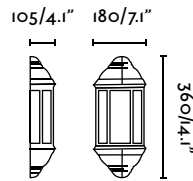
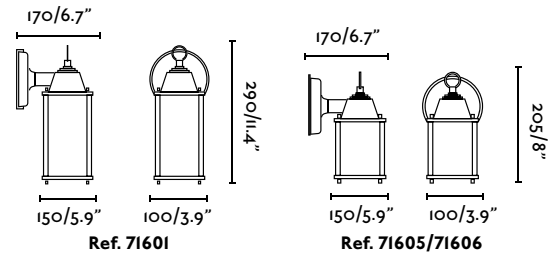

BULB INCLUDED
BOMBILLA INCLUIDA

parMa

1/2 wall lamp

- 73315**  black
negro

1 XE27 MAX 60W NOT INCL. [16466 15W INCL.]

DIE CAST ALUMINIUM+TRANSPARENT POLYCARBONATE/
ALUMINIO INYECTADO+POLICARBONATO TRANSPARENTE

A+ to B (CLASS B INCL) / 220-240V ~ 50-60 Hz / 1.2 kg/2.65 lb

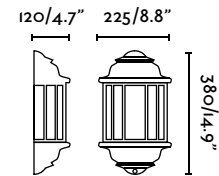

BULB INCLUDED
BOMBILLA INCLUIDA

oRly

1/2 wall lamp

- 71420**  white
blanco

2XE27 MAX 60W NOT INCL. [16466 15W INCL.]

ALUMINIUM+TRANSPARENT GLASS/
ALUMINIO+CRISTAL TRANSPARENTE

A++ to B / 220-240V ~ 50-60 Hz / 2.2 kg/4.85 lb





cripTa

wall lamp

71002  white
blanco

71003  black
negro

71004  grey
gris

1XE27 MAX 60W NOT INCL. [16466]

PVC+METAL+STRIPPED GLASS/
PVC+METAL+CRISTAL RALLADO

A++ to E / 100-240V ~ 50-60 Hz / 0.6 kg/1.32 lb

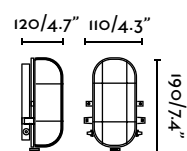



tErra
wall lamp-p

71554 ● black negro

1 X E27 MAX 60W NOT INCL. [16466]
DIE CAST ALUMINIUM+OPAL GLASS/
ALUMINIO INYECTADO+CRISTAL OPAL
A++ to E / 100-240V ~ 50-60 Hz / 0.8 kg/1.76 lb

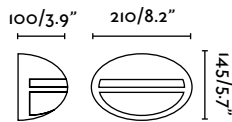

tErra
wall lamp-g

71550 ○ white blanco

71551 ● black negro

1 X E27 MAX 100W NOT INCL. [16466]
DIE CAST ALUMINIUM+OPAL GLASS/
ALUMINIO INYECTADO+CRISTAL OPAL
A++ to E / 100-240V ~ 50-60 Hz / 1.8 kg/3.97 lb

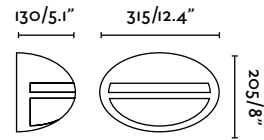

derBy
wall lamp-p

72000 ○ white blanco

72001 ● black negro

1 X E27 MAX 60W NOT INCL. [16592]
DIE CAST ALUMINIUM+TRANSLUCENT GLASS/
ALUMINIO INYECTADO+CRISTAL TRANSLÚCIDO
A++ to E / 100-240V ~ 50-60 Hz / 0.7 kg/1.54 lb

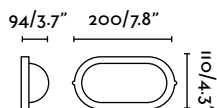

derBy
wall lamp-g

72002 ○ white blanco

1 X E27 MAX 100W NOT INCL. [16466]
DIE CAST ALUMINIUM+TRANSLUCENT GLASS/
ALUMINIO INYECTADO+CRISTAL TRANSLÚCIDO
A++ to E / 100-240V ~ 50-60 Hz / 1.5 kg/3.31 lb

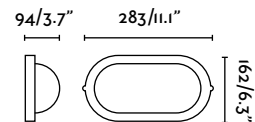



noNo

wall lamp-p

71270  white
blanco

71271  black
negro

1 X E27 MAX 60W NOT INCL. [16592]

DIE CAST ALUMINIUM+TRANSLUCENT GLASS/
ALUMINIO INYECTADO+CRISTAL TRANSLÚCIDO

A++ to E / 100-240V ~ 50-60 Hz / 0.75 kg/1.65 lb

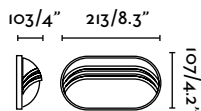

noNo

wall lamp-g

71260  white
blanco

71261  black
negro

1 X E27 MAX 100W NOT INCL. [16466]

DIE CAST ALUMINIUM+TRANSLUCENT GLASS/
ALUMINIO INYECTADO+CRISTAL TRANSLÚCIDO

A++ to E / 100-240V ~ 50-60 Hz / 1.6 kg/3.53 lb

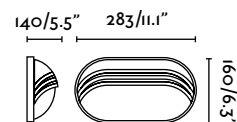

esTay

wall lamp-p

72010  white
blanco

72011  black
negro

1XE27 MAX 60W NOT INCL. [16592]
DIE CAST ALUMINIUM+TRANSLUCENT GLASS/
ALUMINIO INYECTADO+CRISTAL TRANSLÚCIDO
A++ to E / 100-240V ~ 50-60 Hz / 0.72 kg/1.59 lb

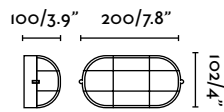

esTay

wall lamp-g

72012  white
blanco

72013  black
negro

1XE27 MAX 100W NOT INCL. [16592]
DIE CAST ALUMINIUM+TRANSLUCENT GLASS/
ALUMINIO INYECTADO+CRISTAL TRANSLÚCIDO
A++ to E / 100-240V ~ 50-60 Hz / 1.48 kg/3.26 lb

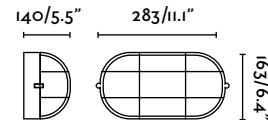

miRto

wall lamp

72070  white
blanco

72071  black
negro

1XE27 MAX 60W NOT INCL. [16620]
PVC/
PVC
A++ to E / 100-240V ~ 50-60 Hz / 0.6 kg/1.32 lb

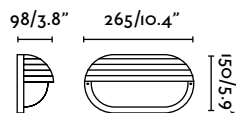



rOndo

wall lamp

71010B  white
blanco

71011N  black
negro

1 X E27 MAX 60W NOT INCL. [16592]

HEAT-RESISTANT ABS+STRIPPED GLASS/
ABS TERMORESISTENTE+CRISTAL RALLADO

A++ to E / 100-240V ~ 50-60 Hz / 0.93 kg/2.05 lb



105/4.1" Ø185/7.2"

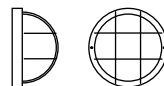

óvAlo

wall lamp

71000  white
blanco

71001  black
negro

1 XE27 MAX 60W NOT INCL. [16592]

HEAT-RESISTANT ABS+STRIPPED GLASS/
ABS TERMORESISTENTE+CRISTAL RALLADO

A++ to E / 100-240V ~ 50-60 Hz / 0.7 kg/1.54 lb

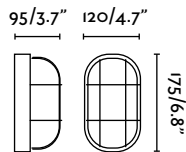

aSkot

wall lamp

72020  white
blanco

1 XE27 MAX 100W NOT INCL. [16592]

DIE CAST ALUMINIUM+TRANSLUCENT GLASS/
ALUMINIO INYECTADO+CRISTAL TRANSLÚCIDO

A++ to E / 100-240V ~ 50-60 Hz / 0.87 kg/1.92 lb



72022  white
blanco

1 XE27 MAX 100W NOT INCL. [16466]

DIE CAST ALUMINIUM+TRANSLUCENT GLASS/
ALUMINIO INYECTADO+CRISTAL TRANSLÚCIDO

A++ to E / 100-240V ~ 50-60 Hz / 1.7 kg/3.75 lb

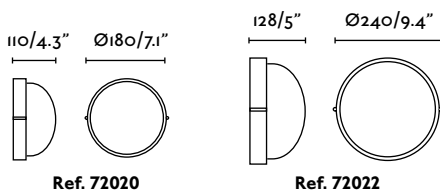

Ref. 72020

Ref. 72022

aMura

wall lamp

72030  white
blanco

72031  black
negro

HF

1 XE27 MAX 60W NOT INCL. [16592]

DIE CAST ALUMINIUM+TRANSLUCENT GLASS/
ALUMINIO INYECTADO+CRISTAL TRANSLÚCIDO

A++ to E / 100-240V ~ 50-60 Hz / 0.88 kg/1.94 lb



72032  white
blanco

1 XE27 MAX 100W NOT INCL. [16466]

DIE CAST ALUMINIUM+TRANSLUCENT GLASS/
ALUMINIO INYECTADO+CRISTAL TRANSLÚCIDO

A++ to E / 100-240V ~ 50-60 Hz / 1.59 kg/3.51 lb

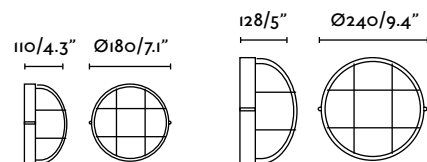

Ref. 72031

Ref. 72030

HF Until stock exhaustion
Hasta final de stock
Jusqu'à la fin de stock

wall & ceiling lamps
aplúques y plafones
appliques et plafonniers
lampe de pariete e plafoniere



hePta

wall lamp

71240  white
blanco

71241  black
negro

1XE27 MAX 100W NOT INCL. [16466]

DIE CAST ALUMINIUM+TRANSLUCENT GLASS/
ALUMINIO INYECTADO+CRISTAL TRANSLÚCIDO

A++ to E / 100-240V ~ 50-60 Hz / 1.6 kg/3.53 lb



132/5.2"

Ø254/10"



spOt

wall lamp

72025



black
negro

1 X E27 MAX 40W NOT INCL. [16622] [LED 17059]

PVC/
PVC

A++ to E / 100-240V ~ 50-60 Hz / 0.66 kg/1.46 lb

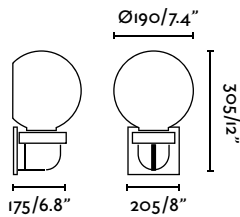

rAdio

wall lamp-p

71503



white
blanco

71505



grey
gris

1 X E27 MAX 60W NOT INCL. [16592] [LED 17059]
DIE CAST ALUMINIUM+TRANSLUCID GLASS/
ALUMINIO INYECTADO+CRISTAL TRANSLÚCIDO
A++ to E / 100-240V ~ 50-60 Hz / 1.02 kg/2.25 lb

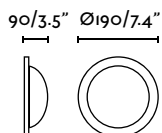

rAdio

wall lamp-g

71500



white
blanco

71501







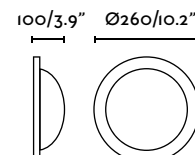





























black
negro

1 X E27 MAX 100W NOT INCL. [16466] [LED 17059]
DIE CAST ALUMINIUM+TRANSLUCID GLASS/
ALUMINIO INYECTADO+CRISTAL TRANSLÚCIDO
A++ to E / 100-240V ~ 50-60 Hz / 1.5 kg/3.31 lb



recessed

empotrables/encastrables/faretti

 baStet <i>[new]</i>	213	 metRic	207
 carTer	215	 mini carTer	215
 ciTrus	209	 mini raCing	214
 croSby	221	 mini-conTra	217
 curTis	221	 mini-gEo	217
 eDel	224	 mySore	228
 esCa	216	 raciNg	215
 fittEr	207	 seDna <i>[new]</i>	203
 hoRus <i>[new]</i>	205	 stoRe <i>[new]</i>	207
 inDi	211	 sUla	211
 lanDai	210	 suRia <i>[new]</i>	223
 lEd-15	225	 taRo <i>[new]</i>	223
 lEd-16	225	 tecNo-1	225
 lEd-18	219	 tecNo-3	229
 lEd-19	226	 tecNo-6	227
 liO	227	 tecNo-7	229
 liSo	217	 tecNo-8	229





RECESSED





IP65
[new] **seDna-1**

recessed

70146  dark grey
gris oscuro

SMD LED 1W 3000K 22LM INCL.DRIVER INCL.

ALUMINIUM/
ALUMINIO

A / 100-240V ~50-60 Hz / 0.24 kg/0.53 lb

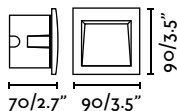

IP65
[new] **seDna-2**

recessed

70147  dark grey
gris oscuro

SMD LED 3W 3000K 93LM INCL.DRIVER INCL.

ALUMINIUM/
ALUMINIO

A / 100-240V ~50-60 Hz / 0.30 kg/0.66 lb

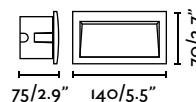

IP65

[new] **seDna-2**

recessed

70147  dark grey
gris oscuro

SMD LED 3W 3000K 93LM INCL.DRIVER INCL.

ALUMINIUM/
ALUMINIO

A / 100-240V ~50-60 Hz / 0.30 kg/0.66 lb

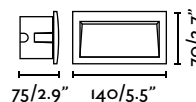

IP65
[new] **seDna-3**

recessed

70148  dark grey
gris oscuro

SMD LED 3W 3000K 122LM INCL.DRIVER INCL.

ALUMINIUM/
ALUMINIO

A / 100-240V ~50-60 Hz / 0.51 kg/1.12 lb

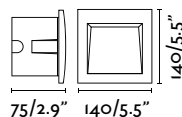



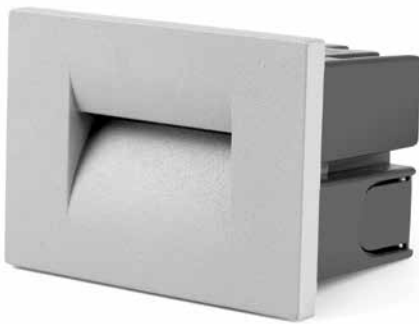

IP65
[new] **hoRus-1**
recessed

70154  grey
gris

SMD LED 4W 3000K 50LM CRI>80 INCL. DRIVER INCL.

DIE CAST ALUMINIUM+POLYCARBONATE/
ALUMINIO INYECTADO+POLICARBONATO

B / 100-240V ~50-60 Hz / 0.34 kg/0.75 lb

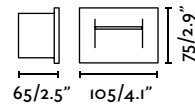

IP65
[new] **hoRus-2**
recessed

70155  grey
gris

SMD LED 4W 3000K 55LM CRI>80 INCL. DRIVER INCL.

DIE CAST ALUMINIUM+POLYCARBONATE/
ALUMINIO INYECTADO+POLICARBONATO

B / 100-240V ~50-60 Hz / 0.36 kg/0.79 lb

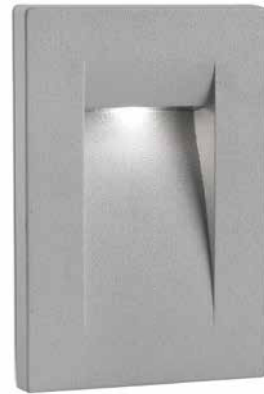
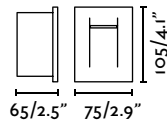



IP65

metRic

recessed

71375

grey
gris

1 XG9 28W NOT INCL. [15615] [LED 17441]
DIE CAST ALUMINIUM+TRANSPARENT GLASS/
ALUMINIO INYECTADO+CRISTAL TRANSPARENTE
A++ to E / 220-240V ~50-60 Hz / 1 kg/2.20 lb



72x220x100

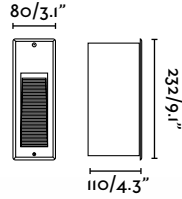

IP65

filtEr

recessed

[new]

70450

grey
gris

2700K

70460

grey
gris

6000K

LED 2W 75LM INCL. DRIVER INCL.
PVC+DIE CAST ALUMINIUM+TEMPERED GLASS/
PVC+ALUMINIO INYECTADO+CRISTAL TEMPLADO
A / 100-240V ~50-60 Hz / 0.1 kg/0.22 lb



98x160x85

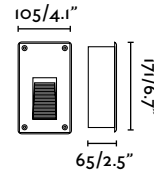

IP65

[new] stoRe

recessed

70451

grey
gris

LED 2W 2700K 90LM INCL. DRIVER INCL.
PVC+DIE CAST ALUMINIUM+TEMPERED GLASS/
PVC+ALUMINIO INYECTADO+CRISTAL TEMPLADO
A / 100-240V ~50-60 Hz / 1 kg/2.20 lb



160x98x85

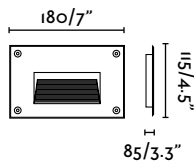



IP65

ciTrus-2

recessed

70561

dark grey
gris oscuro

HIGH POWER LED 3W 4000K 120LM INCL. DRIVER INCL.

DIE CAST ALUMINIUM+TEMPERED GLASS/
ALUMINIO INYECTADO+CRISTAL TEMPLADO

A/ 100-240V ~50-60 Hz / 0.53 kg/1.17 lb

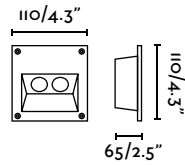
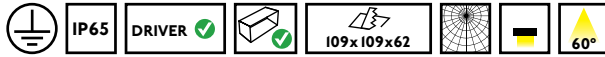

IP65

ciTrus-4

recessed

70562

dark grey
gris oscuro

HIGH POWER LED 4W 4000K 240LM INCL. DRIVER INCL.

DIE CAST ALUMINIUM+TEMPERED GLASS/
ALUMINIO INYECTADO+CRISTAL TEMPLADO

A/ 100-240V ~50-60 Hz / 0.72 kg/1.59 lb

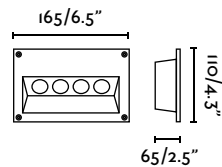



IP65

lanDai

recessed

70400

dark grey
gris oscuro

SMD LED 1W 4000K 30LM INCL. DRIVER INCL.
ALUMINIUM+TRANSPARENT POLYCARBONATE/
ALUMINIO+POLICARBONATO TRANSPARENTE
A++ to A / 220-240V ~ 50-60 Hz / 0.6 kg/1.32 lb

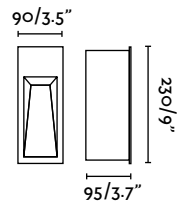

inDi-1

recessed

70632

dark grey
gris oscuro

LED 1W 6500K 48LM INCL. DRIVER INCL.
DIE CAST ALUMINIUM+TRANSPARENT PVC/
ALUMINIO INYECTADO+PVC TRANSPARENTE
A++ to A / 220-230V ~ 50 Hz / 0.38 kg/0.84 lb

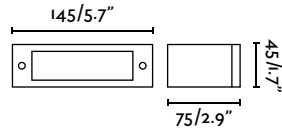

inDi-2

recessed

70633

dark grey
gris oscuro

LED 1W 6500K 48LM INCL. DRIVER INCL.
DIE CAST ALUMINIUM+TRANSPARENT PVC/
ALUMINIO INYECTADO+PVC TRANSPARENTE
A++ to A / 220-230V ~ 50 Hz / 0.37 kg/0.82 lb

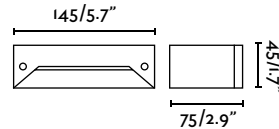

IP65

sUla

recessed

70401

dark grey
gris oscuro

SMD LED 1W 4000K 30LM INCL. DRIVER INCL.
DIE CAST ALUMINIUM+TRANSPARENT POLYCARBONATE/
ALUMINIO INYECTADO+POLICARBONATO TRANSPARENTE
A++ to A / 220-230V ~ 50-60 Hz / 0.45 kg/0.99 lb

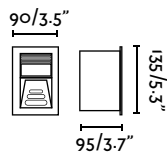

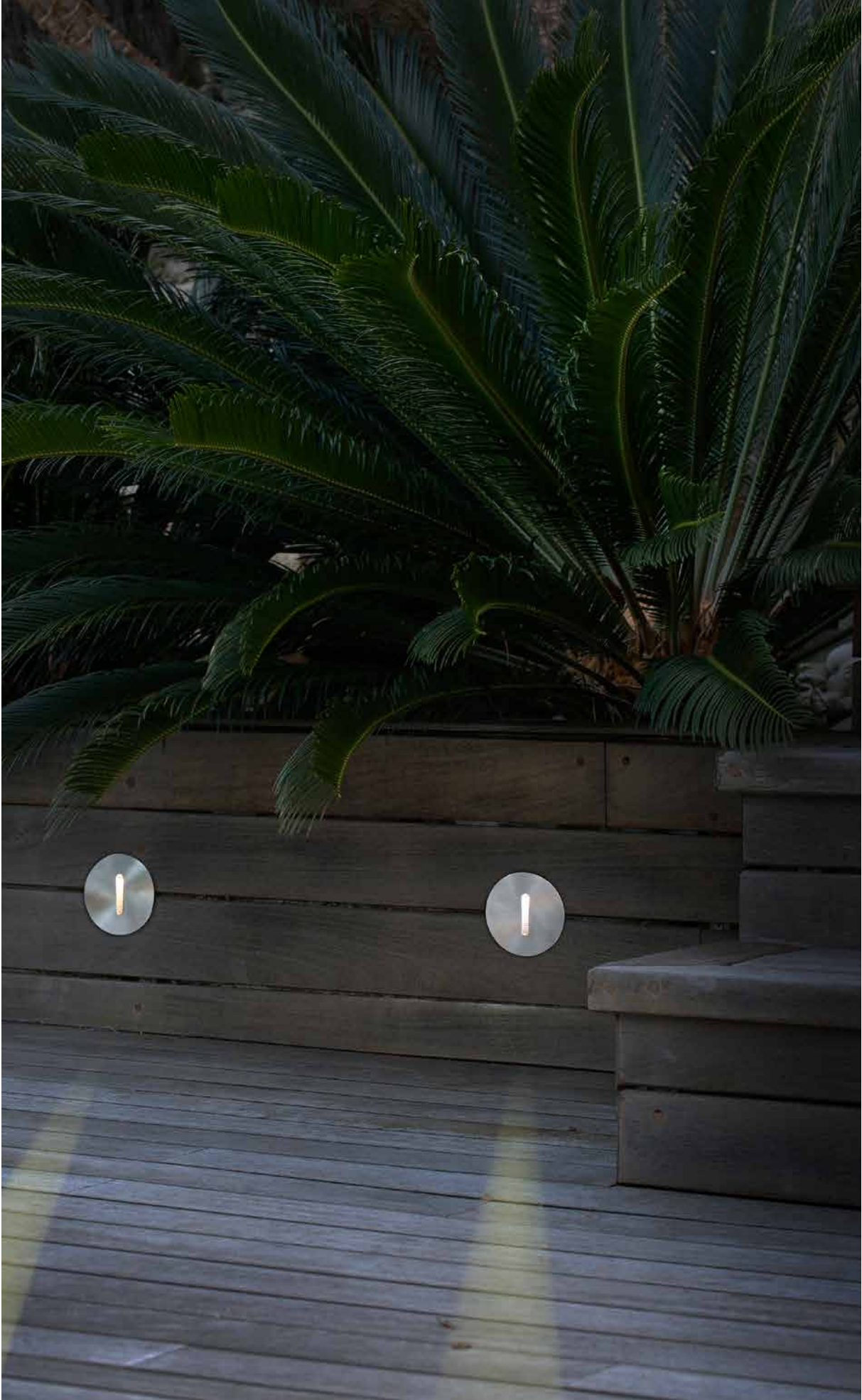

IP65 INOX 304

[new] baStet

recessed

70152

● matt nickel
níquel mate

SMD LED 4W 3000K 25LM CRI<80 INCL. DRIVER INCL.

304 STAINLESS STEEL+GLASS/
AC INOX 304+CRISTAL

B / 100-240V ~50 Hz / 0.38 kg/0.84 lb

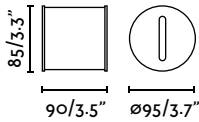

IP65 INOX 304

[new] baStet

recessed

70153

● matt nickel
níquel mate

SMD LED 4W 3000K 25LM CRI<80 INCL. DRIVER INCL.

304 STAINLESS STEEL+GLASS/
AC INOX 304+CRISTAL

B / 100-240V ~50 Hz / 0.42 kg/0.93 lb

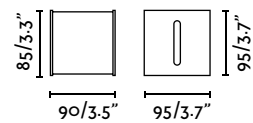

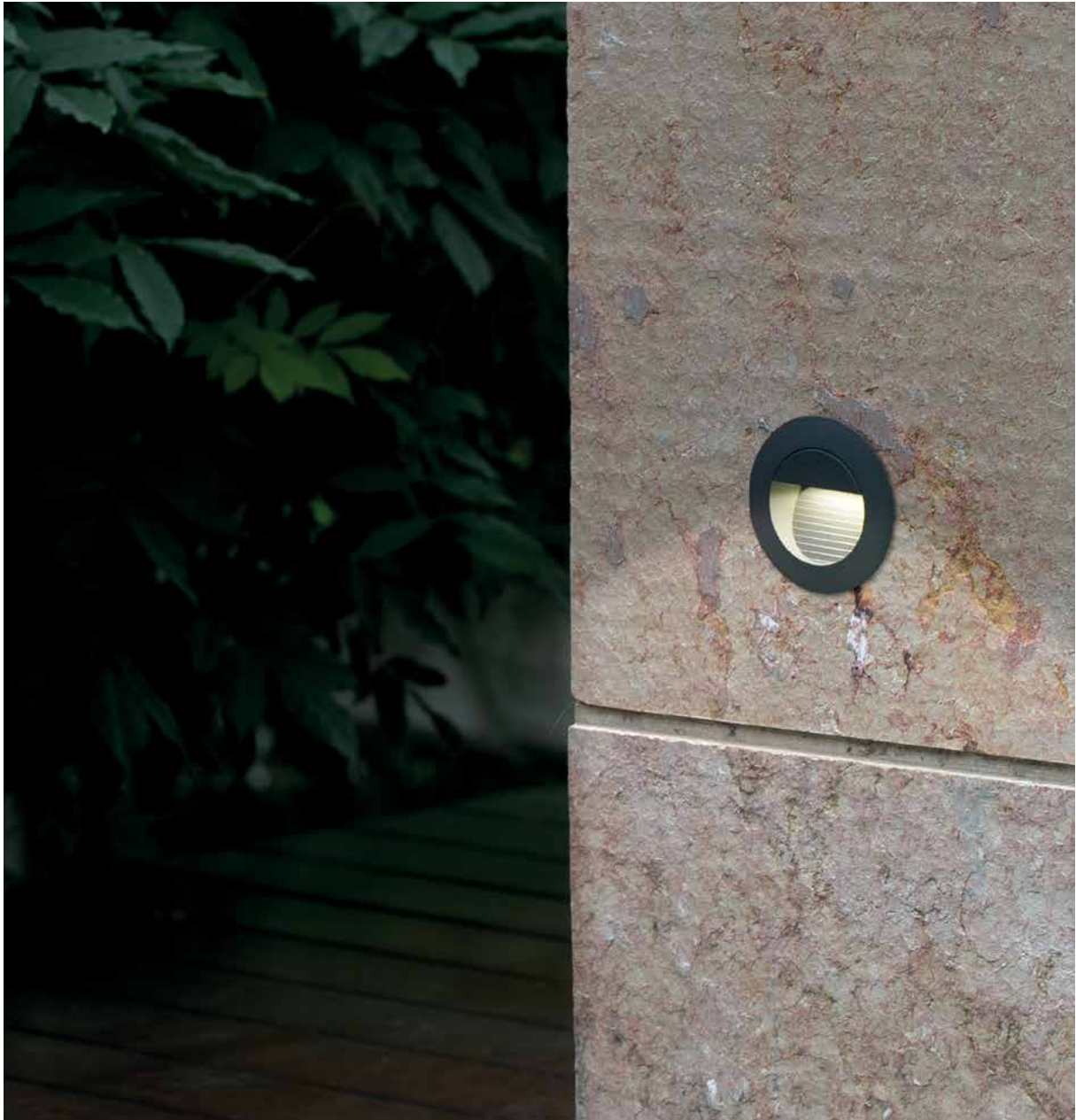

mini raCing

recessed

70403

dark grey
gris oscuro

SMD LED 1,2W 4000K 30LM INCL. DRIVER INCL.

DIE CAST ALUMINIUM+TRANSPARENT PVC/
ALUMINIO INYECTADO+PVC TRANSPARENTE

A / 100-240V ~50-60 Hz / 0.1 kg/0.22 lb

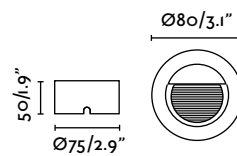

mini carTer

recessed

70402

dark grey
gris oscuro

SMD LED 1,2W 4000K 30LM INCL. DRIVER INCL.

DIE CAST ALUMINIUM+TRANSPARENT PVC/
ALUMINIO INYECTADO+PVC TRANSPARENTE

A to B / 100-240V ~50-60 Hz / 0.2 kg/0.44 lb

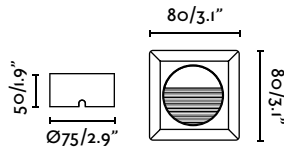

IP65

carTer

recessed

70607

grey
gris

SMD LED 1,4W 4000K 60LM INCL. DRIVER INCL.

DIE CAST ALUMINIUM+TRANSPARENT PVC/
ALUMINIO INYECTADO+PVC TRANSPARENTE

A++ / 100-240V ~50-60 Hz / 0.4 kg/0.88 lb

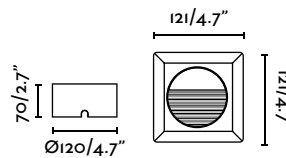

IP65

raciNg

recessed

70606

grey
gris

SMD LED 1,4W 4000K 60LM INCL. DRIVER INCL.

DIE CAST ALUMINIUM+TRANSPARENT PVC/
ALUMINIO INYECTADO+PVC TRANSPARENTE

A++ to A / 220-240V ~ 50-60 Hz / 0.4 kg/0.88 lb

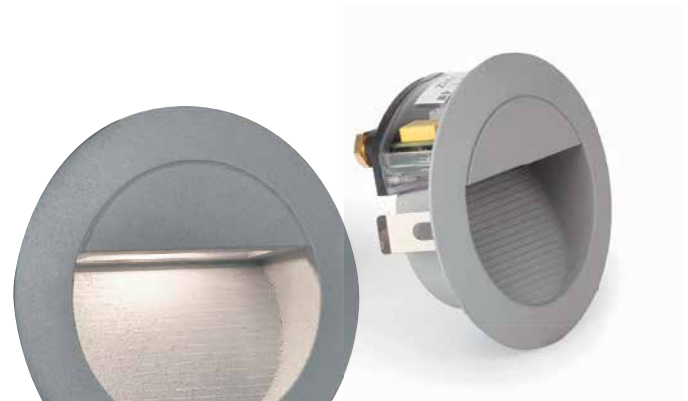
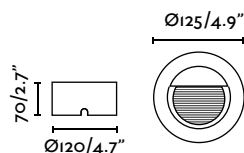

recessed
empotrables
encastrables
faretti



esCa

recessed

71480  white
blanco

71481  black
negro

1 X E27 MAX 40W NOT INCL. [I6620] [LED I7452]

METAL+TRANSLUCENT GLASS/
METAL+CRISTAL TRANSLÚCIDO

A+++ to E / 100-240V ~50-60 Hz / 0.6 kg/1.32 lb



IP44

230x89



71482

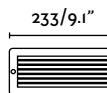



INOX

miNi-conTra

recessed

70600 ● matt nickel níquel mate 8000K

[new] **71354** ● matt nickel níquel mate 3000K

LED 0,5W 30LM INCL. DRIVER INCL.

STAINLESS STEEL+TRANSLUCENT GLASS+PVC/
ACERO INOXIDABLE+CRISTAL TRANSLÚCIDO+PVC

A / 220-240V ~ 50-60 Hz / 0.2 kg/0.44 lb

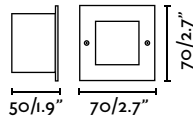

liSo

recessed

71490 ● white blanco

71491 ● black negro

1XE27 MAX 40W NOT INCL. [I6620]

DIE CAST ALUMINIUM+TRANSLUCENT POLYCARBONATE/
ALUMINIO INYECTADO+POLICARBONATO TRANSLÚCIDO

A++ to E / 100-240V ~50-60 Hz / 0.57 kg/1.26 lb

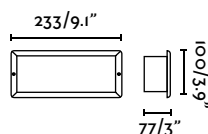
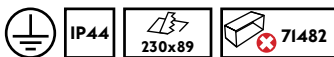

INOX

miNi-gEo

recessed

70602 ● matt nickel níquel mate 8000K

[new] **71355** ● matt nickel níquel mate 3000K

LED 0,7W 40LM INCL. DRIVER INCL.

STAINLESS STEEL+TRANSLUCENT GLASS+PVC/
ACERO INOXIDABLE+CRISTAL TRANSLÚCIDO+PVC

A / 220-240V ~ 50-60 Hz / 0.2 kg/0.44 lb

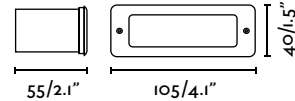

Recessed box for LISO and ESCA
Caja de empotrar para LISO y ESCA

71482 ● dark grey gris oscuro

PVC/
PVC

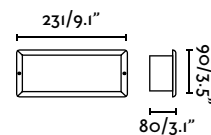

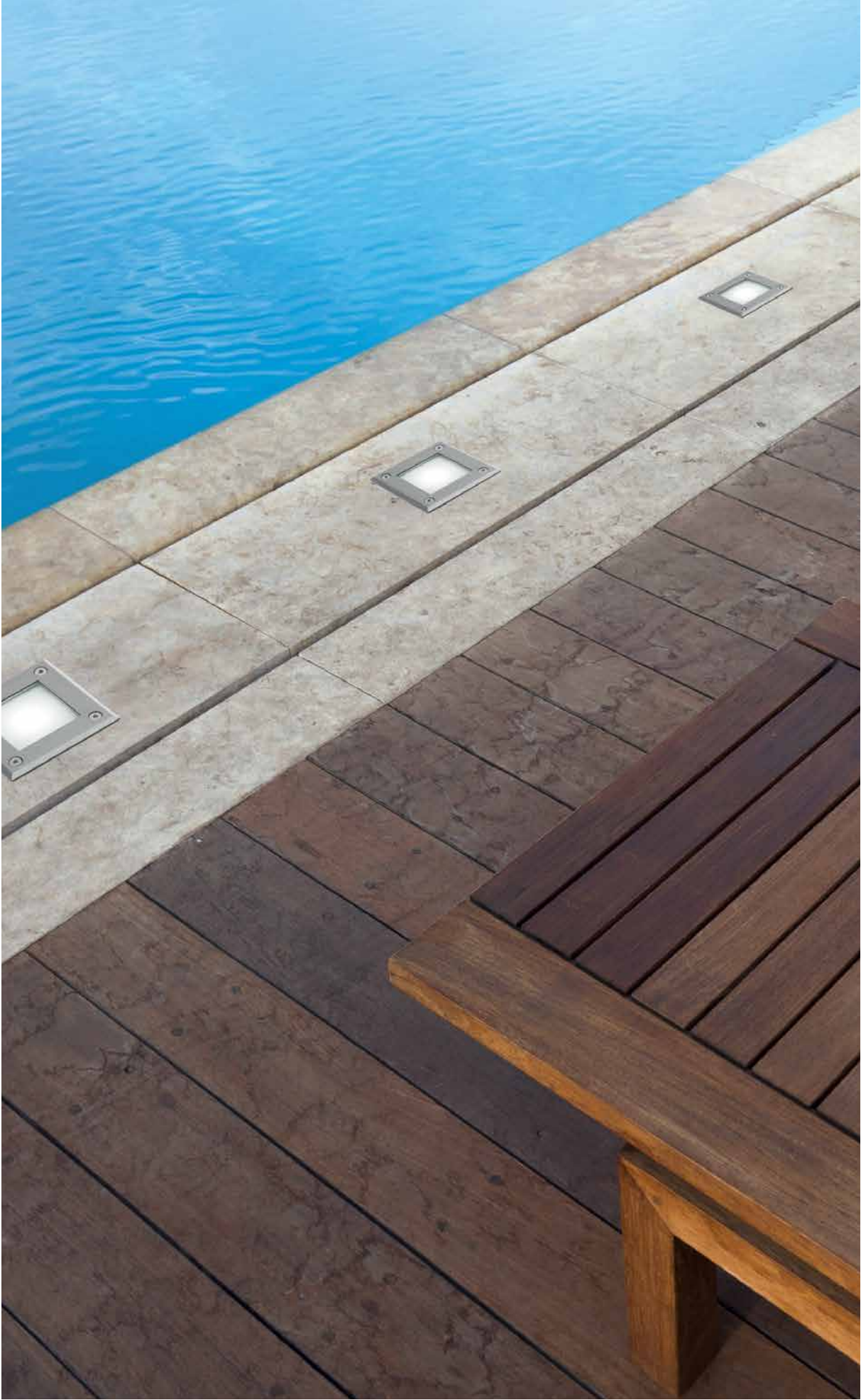



Signaling
Señalización
Signalisation

IP67

LEd-18

recessed

71497 matt nickel 6000K
níquel mate

71499 matt nickel 3000K
níquel mate

HIGH POWER LED 3W 160LM INCL. DRIVER INCL.

STEEL+DIE CAST ALUMINIUM+TRANSPARENT GLASS+POLYCARBONATE/
ACERO+ALUMINIO INYECTADO+CRISTAL TRANSPARENTE+POLICARBONATO

A++ to A / 220-240V ~ 50-60 Hz / 0.81 kg/1.79 lb

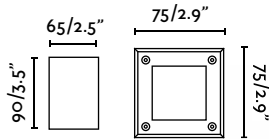

Lighting
Iluminación
Eclairage



Signaling
Señalización
Signalisation



Lighting
Iluminación
Eclairage

IP67

LEd-18

recessed

71496 matt nickel 6000K
níquel mate

71498 matt nickel 3000K
níquel mate

HIGH POWER LED 3W 160LM INCL. DRIVER INCL.

STEEL+DIE CAST ALUMINIUM+TRANSPARENT GLASS+POLYCARBONATE/
ACERO+ALUMINIO INYECTADO+CRISTAL TRANSPARENTE+POLICARBONATO

A++ to A / 100-240V ~50-60 Hz / 0.81 kg/1.79 lb

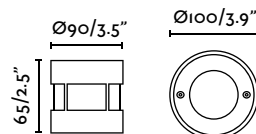

Very important: see drainage specifications and IP for recesseds, pag. 279
Consulte las especificaciones de drenaje e IP para empotrables de suelo, pág. 279
Très important: voir spécifications pour le drainage et IP de l'encastrables, pag. 279

recessed
empotrables
encastrables
faretti



IP67

INOX 316

croSby**recessed**

70458N ● matt nickel 6000K
níquel mate 120 - 240V / 85Lm

70459N ● matt nickel 3000K
níquel mate 100 - 240V / 77Lm

HIGH POWER LED 2W INCL. DRIVER INCL.

STAINLESS STEEL 304+DIE CAST ALUMINIUM+TEMPERED GLASS+ABS/
ACERO INOXIDABLE 304+ALUMINIO INYECTADO+CRISTAL TEMPLADO+ABS

A+ / 50-60 Hz / 1.1 kg/2.43 lb



70452 ● matt nickel 6000K 85Lm
níquel mate 24V

HF

70453 ● matt nickel 3000K 77Lm
níquel mate 24V

LED 3W INCL. DRIVER 24V NOT INCL. [46067]

STAINLESS STEEL 304+DIE CAST ALUMINIUM+TEMPERED GLASS+ABS/
ACERO INOXIDABLE 304+ALUMINIO INYECTADO+CRISTAL TEMPLADO+ABS

A / 24V ~50-60 Hz / 0.34 kg/0.75 lb

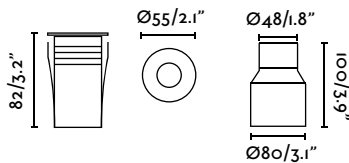

HF Until stock exhaustion
Hasta final de stock
Jusqu'à la fin de stock

IP67

INOX 316

curTis**recessed**

70462N ● matt nickel 3000K
níquel mate

70463N ● matt nickel 6000K
níquel mate

HIGH POWER LED 2W INCL. 77LM DRIVER INCL.

STAINLESS STEEL 316+ALUMINIUM+TEMPERED GLASS+ABS/
ACERO INOXIDABLE 316+ALUMINIO+CRISTAL TEMPLADO+ABS

A+ / 100-240V ~50-60 Hz / 0.36 kg/0.79 lb

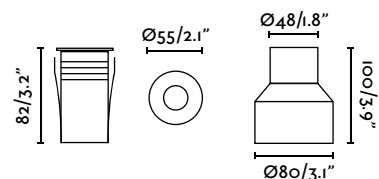

Very important: see drainage specifications and IP for recesseds, pag. 279
Consulte las especificaciones de drenaje e IP para empotrables de suelo, pag. 279
Très important: voir spécifications pour le drainage et IP de l'encastrables, pag. 279

recessed
empotrables
encastrables
faretti

221

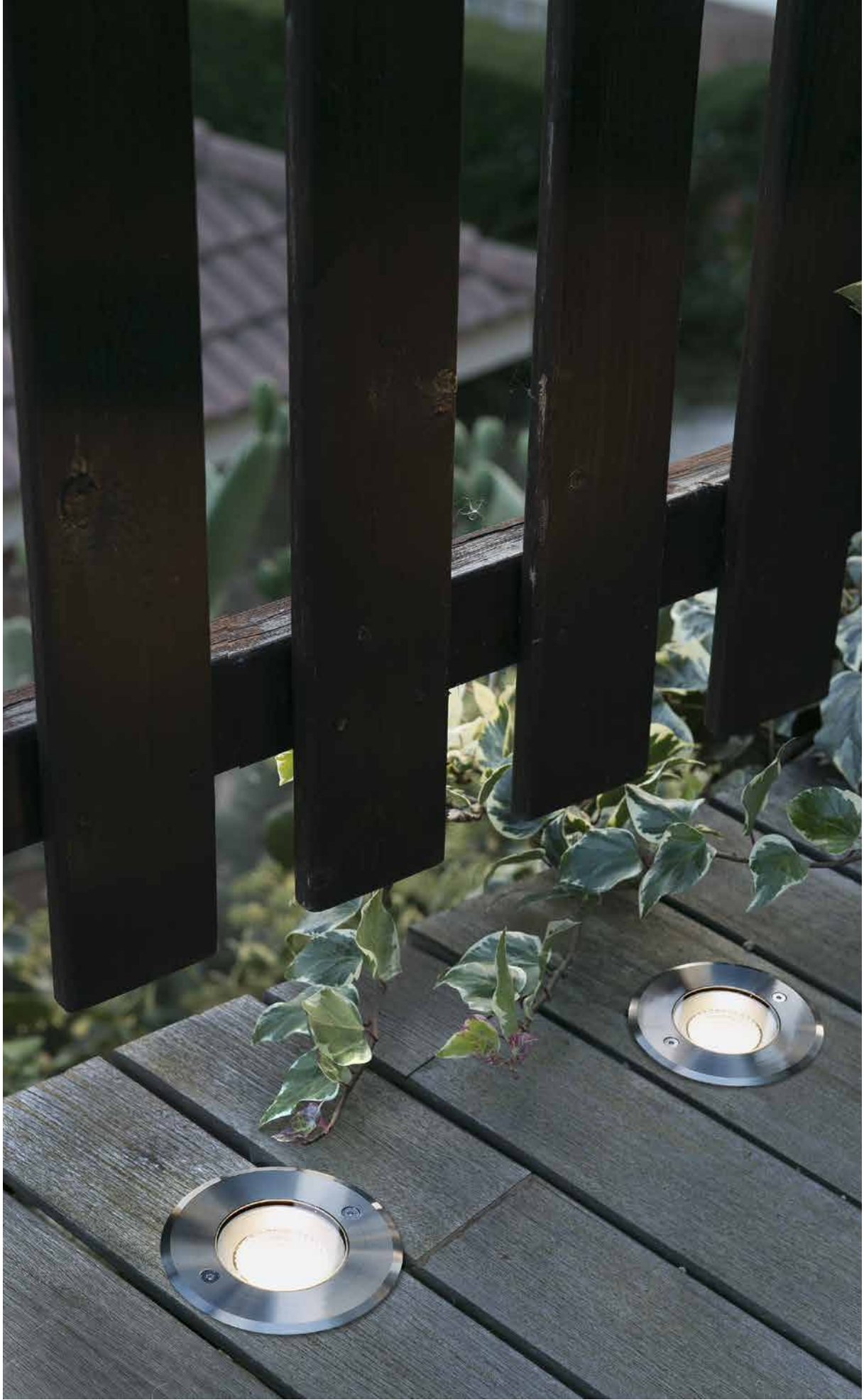

IP67

INOX 304

[new] **suRia-3****recessed**

70592

matt nickel
níquel mate

COB LED 3W 3000K 450LM DRIVER INCL.

304 STAINLESS STEEL+GLASS/
AC INOX 304+CRISTAL

A / 100-240V ~50-60 Hz / 0.67 kg/1.48 lb

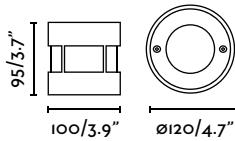

IP67

INOX 304

[new] **suRia-12****recessed**

70593

matt nickel
níquel mate

COB LED 12W 3000K 1200LM INCL. DRIVER INCL.

304 STAINLESS INOX+GLASS/
AC INOX 304+CRISTAL

A / 100-240V ~50-60 Hz / 1.94 kg/4.28 lb

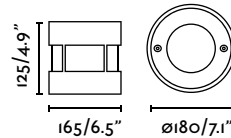

IP67

INOX 316

[new] **taRo****recessed**

70449

matt nickel
níquel mate

COB LED 7W 3000K 280LM CRI >80 INCL. DRIVER INCL.

316 STAINLESS INOX+GLASS/
AC INOX 316+CRISTAL

A / 100-240V ~ 50-60 Hz / 0.58 kg/1.28 lb

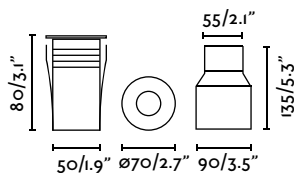

Very important: see drainage specifications and IP for recesseds, pag. 279
Consulte las especificaciones de drenaje e IP para empotrables de suelo, pag. 279
Très important: voir spécifications pour le drainage et IP de l'encastables, pag. 279

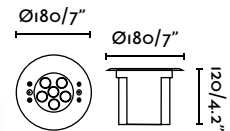



IP68

INOX

eDel

recessed

70455  matt nickel / níquel mate 4000K / 900Lm

70456  matt nickel / níquel mate  RGB RGB

HIGH POWER LED 18W DRIVER 24V 20W NOT INCL. [46067]

STAINLESS STEEL 316+TRANSPARENT GLASS+PVC/
ACERO INOXIDABLE 316+CRISTAL TRANSPARENTE+PVC

A / 24Vdc ~50-60 Hz / 1.65 kg/3.64 lb



VERY IMPORTANT: TO BE USED ONLY UNDERWATER
IMPORTANTE: USO EXCLUSIVO SÓLO BAJO EL AGUA

RGB accessories

Accesorios RGB



46067 Fuente de alimentación 24V 20W

70472 Controlador LED RGB MASTER 24V 72W

70474 Control remoto IR RGB

70475 Receptor IR RGB

70476 Controlador LED RGB SLAVE 24V 72W

IP67

Led-15

recessed

70544



grey
gris

LED 4W 6000K 10LM INCL. DRIVER INCL.

DIE CAST ALUMINIUM/
ALUMINIO INYECTADO

A / 100-240V ~50-60 Hz / 1.05 kg/2.31 lb

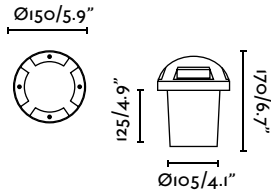

IP67 INOX

Led-16

recessed

70545



matt nickel
níquel mate

LED 2W 6500K 30LM INCL. DRIVER INCL.

STAINLESS STEEL+PVC+TRANSPARENT GLASS/
ACERO INOXIDABLE+PVC+CRISTAL TRANSPARENTE

A / 100-240V ~50-60 Hz / 0.63 kg/1.39 lb

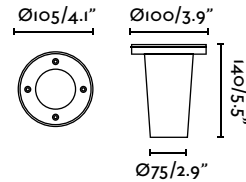

IP67 INOX

tecNo-1

recessed

71483

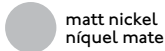

matt nickel
níquel mate

1XE27 MAX 60W NOT INCL. [16466] [LED 17059]

STAINLESS STEEL+DIE CAST ALUMINIUM+TRANSPARENT GLASS/
ACERO INOXIDABLE+ALUMINIO INYECTADO+CRISTAL TRANSPARENTE

A++ to E / 100-240V ~50-60 Hz / 2.13 kg/4.70 lb

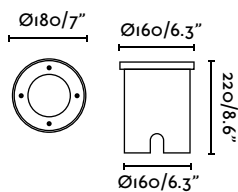

Very important: see drainage specifications and IP for recesseds, pag. 279
Consulte las especificaciones de drenaje e IP para empotrables de suelo, pág. 279
Très important: voir spécifications pour le drainage et IP de l'encastables, pag. 279



IP67

Led-19

recessed

70596

● matt nickel
níquel mate

LED 3W 3000K 210LM INCL. DRIVER INCL.

DIE CAST ALUMINIUM+TRANSPARENT GLASS/
ALUMINIO INYECTADO+CRISTAL TRANSPARENTE

A/ 100-240V ~50-60 Hz / 0.78 kg/1.72 lb

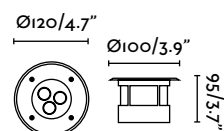

Very important: see drainage specifications and IP for recesseds, pag. 279
 Consulte las especificaciones de drenaje e IP para empotrables de suelo, pág. 279
 Très important: voir spécifications pour le drainage et IP de l'encastables, pag. 279

IP67 INOX

lio

recessed

71495  matt nickel
níquel mate

1 XGX53 9W 4000K 330LM INCL.
STAINLESS STEEL+TRANSPARENT GLASS/
ACERO INOXIDABLE+CRISTAL TRANSPARENTE
A++ / 100-240V ~50-60 Hz / 0.66 kg/1.46 lb

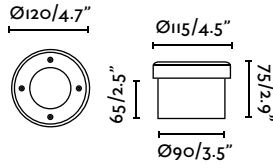

IP67 INOX

tecNo-6

recessed

71489  matt nickel
níquel mate

1 XGU10 MAX 50W NOT INCL. [LED 14141]
STAINLESS STEEL+TRANSPARENT GLASS/
ACERO INOXIDABLE+CRISTAL TRANSPARENTE
A++ / 100-240V ~50-60 Hz / 0.79 kg/1.74 lb

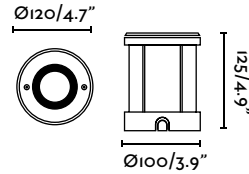

IP67 INOX

tecNo-6

recessed

71488  matt nickel
níquel mate

1 XGU10 MAX 11W NOT INCL. [14030]
STAINLESS STEEL+TRANSPARENT GLASS
ACERO INOXIDABLE+CRISTAL TRANSPARENTE
A++ / 100-240V ~50-60 Hz / 0.81 kg/1.79 lb

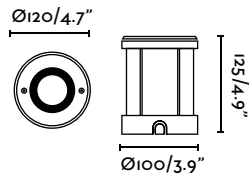

Very important: see drainage specifications and IP for recesseds, pag. 279
Consulte las especificaciones de drenaje e IP para empotrables de suelo, pág. 279
Très important: voir spécifications pour le drainage et IP de l'encastrables, pag. 279



IP67

mySore

recessed

71476

● matt nickel
níquel mate

1 X T5 G5 24W NOT INCL. GEAR INCL.

DIE CAST ALUMINIUM+STAINLESS STEEL+TRANSPARENT GLASS/
ALUMINIO INYECTADO+ACERO INOXIDABLE+CRISTAL TRANSPARENTE

A++ to E / 220-240V ~50-60 Hz / 5.83 kg/21.85 lb

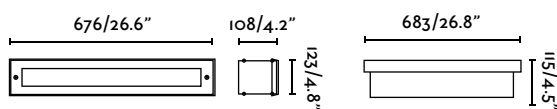

IP67 INOX

tecNo-7

recessed

71492

● matt nickel
níquel mate

I XG I2 HQI 35/70/150W NOT INCL. [9733I035/9733I070/9733I150]
GEAR NOT INCL. [984I1035ST / 984I1150 / 984I1070ST]

STAINLESS STEEL+DIE CAST ALUMINIUM+TRANSPARENT GLASS
ACERO INOXIDABLE+ALUMINO INYECTADO+CRISTAL TRANSPARENTE

A++ to A / 220-240V ~50-60 Hz / 5 kg/11.02 lb

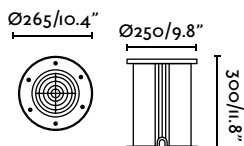
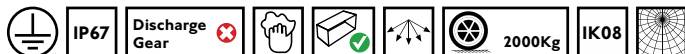

ANTI GLARE
ANTIDESLUMBRANTE IP67 INOX

tecNo-8

recessed

71506

● matt nickel
níquel mate

I XQR III MAX 50W NOT INCL. GEAR NOT INCL.

POLYCARBONATE+STAINLESS STEEL+DIE CAST ALUMINIUM+TRANSPARENT GLASS/
POLICARBONATO+ACERO INOXIDABLE+ALUMINO INYECTADO+CRISTAL TRANSPARENTE

A++ to E / 220-240V ~50-60 Hz / 3.72 kg/8.20 lb

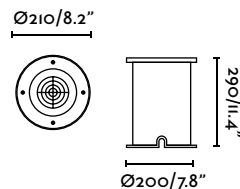

IP67 INOX

tecNo-3

recessed

71485

● matt nickel
níquel mate

I XR7S HQI 70W NOT INCL. [9734I070] GEAR VOSSLOH-SCHWABE INCL.

STAINLESS STEEL+DIE CAST ALUMINIUM+TRANSPARENT GLASS/
ACERO INOXIDABLE+ALUMINO INYECTADO+CRISTAL TRANSPARENTE

A++ to E / 220-240V ~50-60 Hz / 5.6 kg/12.35 lb

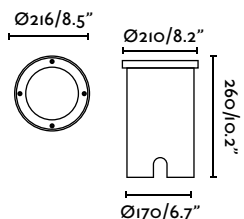
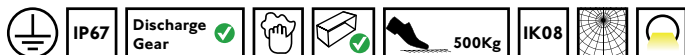

























Very important: see drainage specifications and IP for recesseds, pag. 279
Consulte las especificaciones de drenaje e IP para empotrables de suelo, pág. 279
Très important: voir spécifications pour le drainage et IP de l'encastrables, pag. 279

recessed
empotrables
encastrables
faretti

projectors&spikes

proyectores y estacas/projecteurs et piquets/proiettori e pichetti

 aPolo	243	 naVa	244
 aRan	237	 nEbel	249
 aTon [new]	236	 onDa	244
 baLder [new]	247	 paRk	235
 gaRda	248	 poLa	243
 gartEn	251	 pRoject	232
 geRa	237	 sAnsón	243
 hOkI	245	 sEth [new]	247
 kaRa	240	 soBek [new]	246
 kOnic	242	 sPike	251
 lEd-9	249	 tOno	251
 maDol	241	 toRan	239



PROJECTORS & SPIKES

projectors & spikes
projectores y estacas
projecteurs et piquets
proiettori e picchetti



pProject

by Manel Llusçà

Made in cast aluminum and available in two sizes and different finishes. It is swivel both vertically and horizontally.

Realizado en aluminio inyectado y disponible en dos tamaños y acabados distintos. Es totalmente orientable, tanto vertical como horizontalmente.

Modèles disponibles en diverses dimensions et couleurs. Vous pouvez l'orienter comme vous le souhaitez, aussi bien horizontalement que verticalement.



ORIENTABLE

IP65

projector

71383  grey
gris

71390  dark grey
gris oscuro

1 XGU10 MAX 50W NOT INCL. [I4030] [LED I4141]
DIE CAST ALUMINIUM+TRANSPARENT GLASS/
ALUMINIO INYECTADO+CRISTAL TRANSPARENTE
A++ to E / 100-240V ~ 50-60 Hz / 0.58 kg/1.28 lb

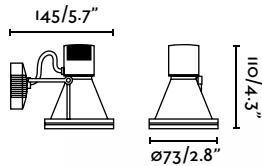
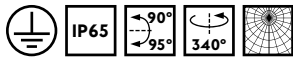

ORIENTABLE

IP65

projector

71382  grey
gris

71389  dark grey
gris oscuro

1 XE27 PAR 38 20W NOT INCL. [LED I7400]
DIE CAST ALUMINIUM+TRANSPARENT GLASS/
ALUMINIO INYECTADO+CRISTAL TRANSPARENTE
A++ to B / 100-240V ~ 50-60 Hz / 1.6 kg/3.53 lb

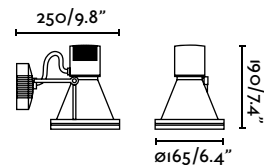

projectors & spikes
projectores y estacas
projecteurs et piquets
proiettori e pichetti



IP65

paRk-1

projector

71391

dark grey
gris oscuro

HF



1 XG12 HQI MAX 35W NOT INCL. [97331035] GEAR PHILIPS INCL.

DIE CAST ALUMINIUM+TEMPERED GLASS/
ALUMINIO INYECTADO+CRISTAL TEMPLADO

A++ to E / 220-240V ~ 50-60 Hz / 2.7 kg/5.95 lb

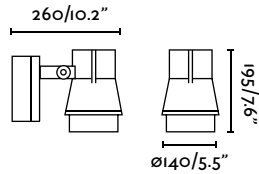

IP65

paRk-3

projector

71393

dark grey
gris oscuro

HF

1 XG12 HQI 150W NOT INCL. GEAR PHILIPS INCL.

DIE CAST ALUMINIUM+TEMPERED GLASS/
ALUMINIO INYECTADO+CRISTAL TEMPLADO

A++ to E / 220-240V ~ 50-60 Hz / 5.5 kg/12.13 lb

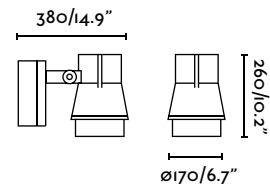
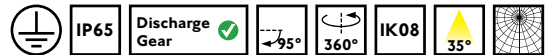

HF

Until stock exhaustion
Hasta final de stock
Jusqu'à la fin de stock

projectors & spikes
proyectors y estacas
projecteurs et piquets
proiettori e pichetti

235

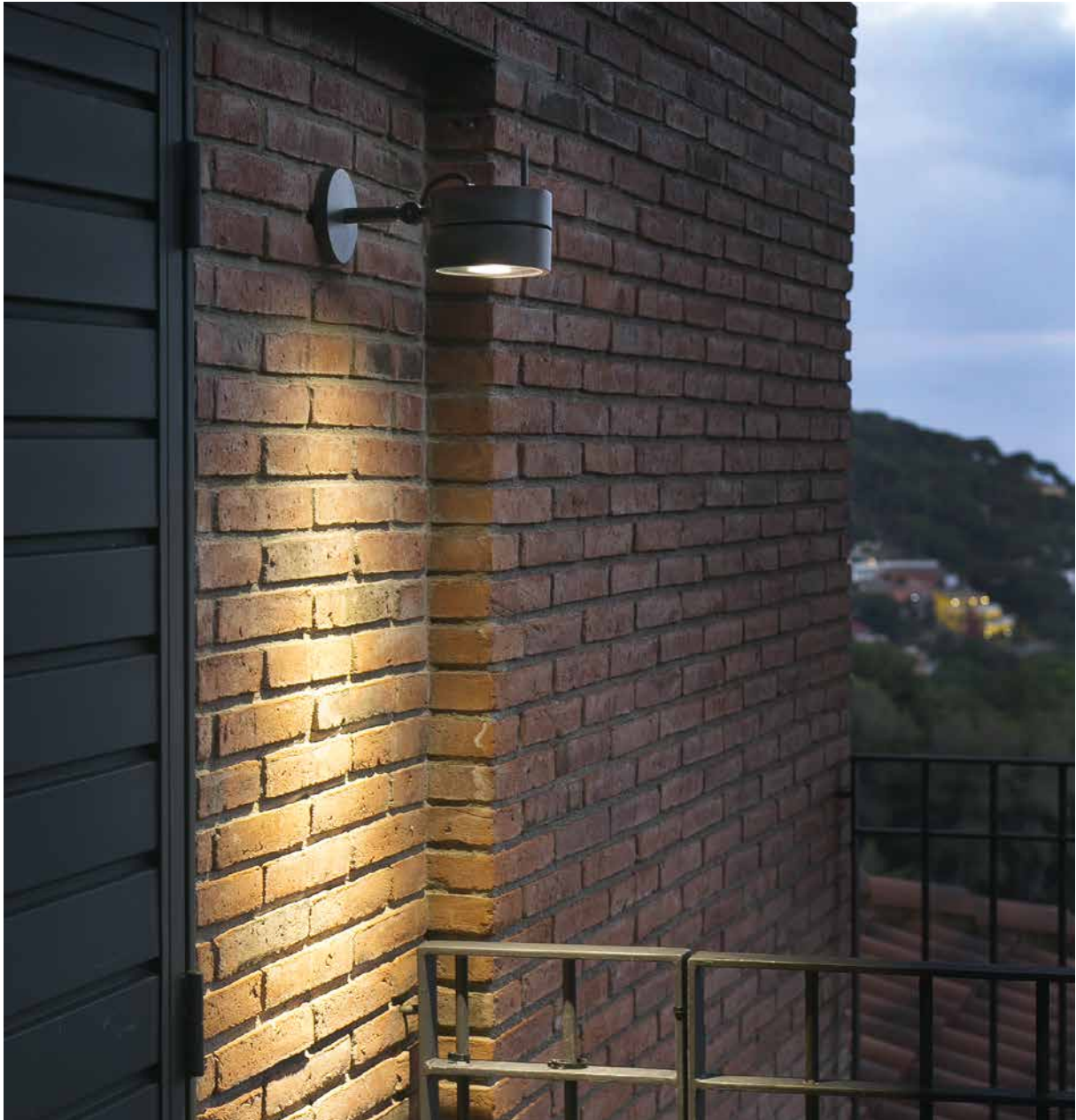

IP65

[new] **aTon**
projector

70150

dark grey
gris oscuro

COB LED 15W 4000K 1125LM CRI>80 INCL.DRIVER INCL.

DIE CAST ALUMINIUM+TRANSLUCENT GLASS/
ALUMINIO INYECTADO+CRISTAL TRANSLÚCIDO

A / 100-240V ~ 50-60 Hz / 1.94 kg/4.98 Lb

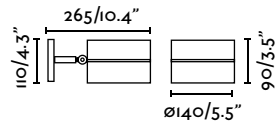

geRa

projector

70138

● dark grey
gris oscuro

SMD LED 5W 4000K 280LM INCL. DRIVER INCL.
DIE CAST ALUMINIUM+TRANSPARENT GLASS/
ALUMINIO INYECTADO+CRISTAL TRANSPARENTE

A++ to A / 220-240V ~ 50-60 Hz / 0.6 kg/1.32 lb

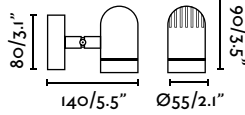

IP65

aRan

projector

70137

● dark grey
gris oscuro

SMD LED 17W 4000K 1440LM INCL. DRIVER INCL.

DIE CAST ALUMINIUM+TRANSPARENT GLASS/
ALUMINIO INYECTADO+CRISTAL TRANSPARENTE

A / 100-240V ~ 50-60 Hz / 1.2 kg/2.65 lb

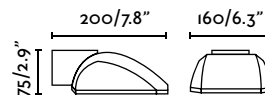



toRan-1

projector

70139

dark grey
gris oscuro

SMD LED 5W 4000K 345LM INCL. DRIVER INCL.

DIE CAST ALUMINIUM+TRANSPARENT GLASS/
ALUMINIO INYECTADO+CRISTAL TRANSPARENTE

A++ to A / 220-240V ~ 50-60 Hz / 0.6 kg/1.32 lb

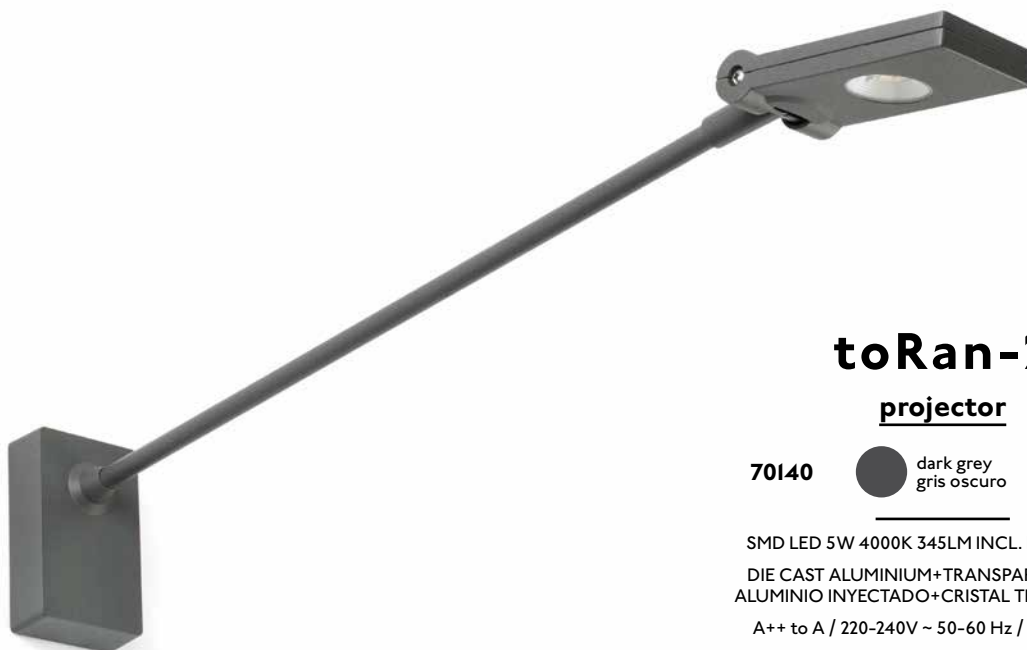
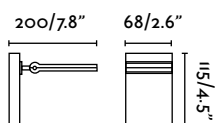

toRan-2

projector

70140

dark grey
gris oscuro

SMD LED 5W 4000K 345LM INCL. DRIVER INCL.

DIE CAST ALUMINIUM+TRANSPARENT GLASS/
ALUMINIO INYECTADO+CRISTAL TRANSPARENTE

A++ to A / 220-240V ~ 50-60 Hz / 0.8 kg/1.76 lb

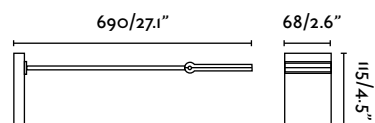



IP65

kaRa-1

projector/spike

70141 ● black negro 3000K 730LM

70142 ● black negro 5000K 750LM

COB LED 10W 5000K CRI>80 DRIVER INCL.

DIE CAST ALUMINIUM/
ALUMINIO INYECTADO

A+ / 100-240V ~ 50 Hz / 0.57 kg/1.25 lb

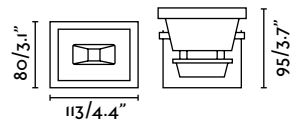

maDol

projector

70023



1 XE27 MAX 23W NOT INCL. [I6464]

POLYCARBONATE+TRANSPARENT GLASS/
POLICARBONATO+CRISTAL TRANSPARENTE

A++ to B / 100-240V ~ 50 Hz / 1 kg/2.20 lb

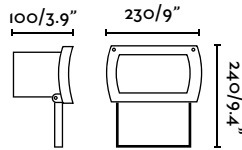

IP65

kaRa-2

projector/spike

70143



COB LED 30W 5000K 2250LM CRI<80 INCL. DRIVER INCL.

DIE CAST ALUMINIUM/
ALUMINIO INYECTADO

A / 100-240V ~ 50 Hz / 2.50 kg/5.51 lb

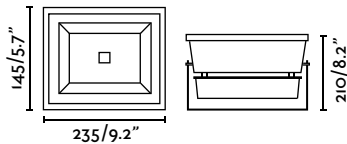

Spike accessory for KARA-1/KARA-2
Estaca accesorio para KARA-1/KARA-2

70525



DIE CAST ALUMINIUM/
ALUMINIO INYECTADO

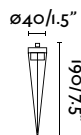

IP65

kaRa-3

projector

70144



COB LED 50W 5000K 4000LM CRI<80 INCL. DRIVER INCL.

DIE CAST ALUMINIUM/
ALUMINIO INYECTADO

A+ / 100-240V ~ 50 Hz / 4.0 kg/8.81 lb

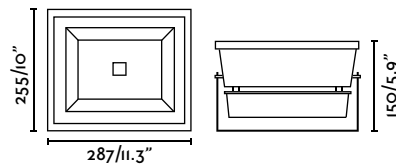



IP65

kOnic projector

70012

grey
gris

1 XR7S JP78 MAX 150W NOT INCL. [I2031]
DIE CAST ALUMINIUM+TRANSPARENT GLASS/
ALUMINIO INYECTADO+CRISTAL TRANSPARENTE

A++ to E / 100-240V ~ 50 Hz / 1.6 kg/3.53 lb

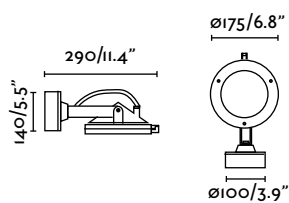
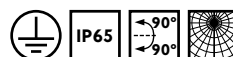



IP65

poLa projector

73131

● black
negro

1 XMR16 ECOHALOGEN 50W NOT INCL. [14108] [LED 14143]
GEAR 60W NOT INCL. [43070]

DIE CAST ALUMINIUM+TRANSPARENT GLASS/
ALUMINIO INYECTADO+CRISTAL TRANSPARENTE

B to E / 12V ~ 50 Hz / 0.34 kg/0.75 lb

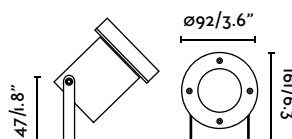
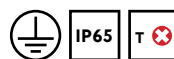

IP65

aPolo projector

70021

● black
negro

2XG24 q-3 32W INCL. GEAR INCL.

PVC+METAL+TRANSPARENT GLASS/
PVC+METAL+CRISTAL TRANSPARENTE

A to B / 220-230V ~ 50 Hz / 3.2 kg/7.05 lb

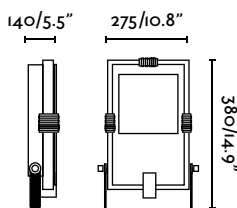

IP65

sAnsón projector

70219

● black
negro

1 XE40 400W NOT INCL. GEAR INCL.

DIE CAST ALUMINIUM+TRANSPARENT GLASS/
ALUMINIO INYECTADO+CRISTAL TRANSPARENTE

A++ to E / 220-240V ~ 50-60 Hz / 12.35 kg/27.23 lb

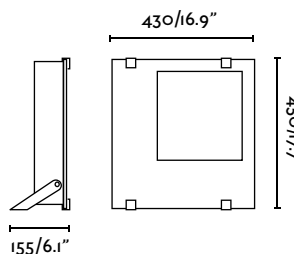

IP68

nAva

projector

70122

● black
negro

HIGH POWER LED 15W 6000K 800LM INCL. DRIVER 46061 350MA DC 40-50V NOT INCL.

DIE CAST ALUMINIUM+GLASS/
ALUMINIO INYECTADO+CRISTAL

A / 100-240V ~ 50-60 Hz / 1.8 kg/3.97 lb

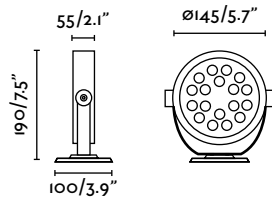

IP65

onDa

wall washer

70120

● black
negro

HIGH POWER LED 18W 6000K 950LM INCL. DRIVER INCL.

ALUMINIUM+TRANSPARENT GLASS/
ALUMINO+CRISTAL TRANSPARENTE

A++ to E / 220-240V ~ 50-60 Hz / 4.63 kg/10.21 lb

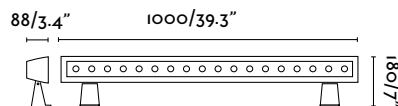



IP65

hOki-1

wall washer

300603000F  grey 3000K HF

300603001F  grey 5000K HF

 **300603002F**  grey RGB HF

HIGH POWER LED 28W INCL. DRIVER INCL.
DIE CAST ALUMINIUM+TRANSPARENT GLASS/
ALUMINO INYECTADO+CRISTAL TRANSPARENTE
A+++ to A / 220-240V ~ 50-60 Hz / 4.5 kg/9.92 lb

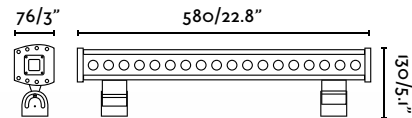

IP65

hOki-2

wall washer

300600000F  grey 3000K HF

300600001F  grey 5000K HF

HIGH POWER LED 56W INCL. DRIVER INCL.
DIE CAST ALUMINIUM+TRANSPARENT GLASS/
ALUMINO INYECTADO+CRISTAL TRANSPARENTE
A+++ to A / 220-240V ~ 50-60 Hz / 7 kg/15.43 lb

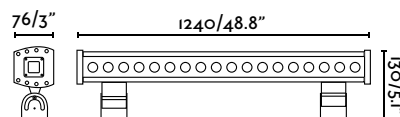

HF Until stock exhaustion
Hasta final de stock
Jusqu'à la fin de stock

projectors & spikes
projectores y estacas
projecteurs et piquets
proiettori e pichetti

245

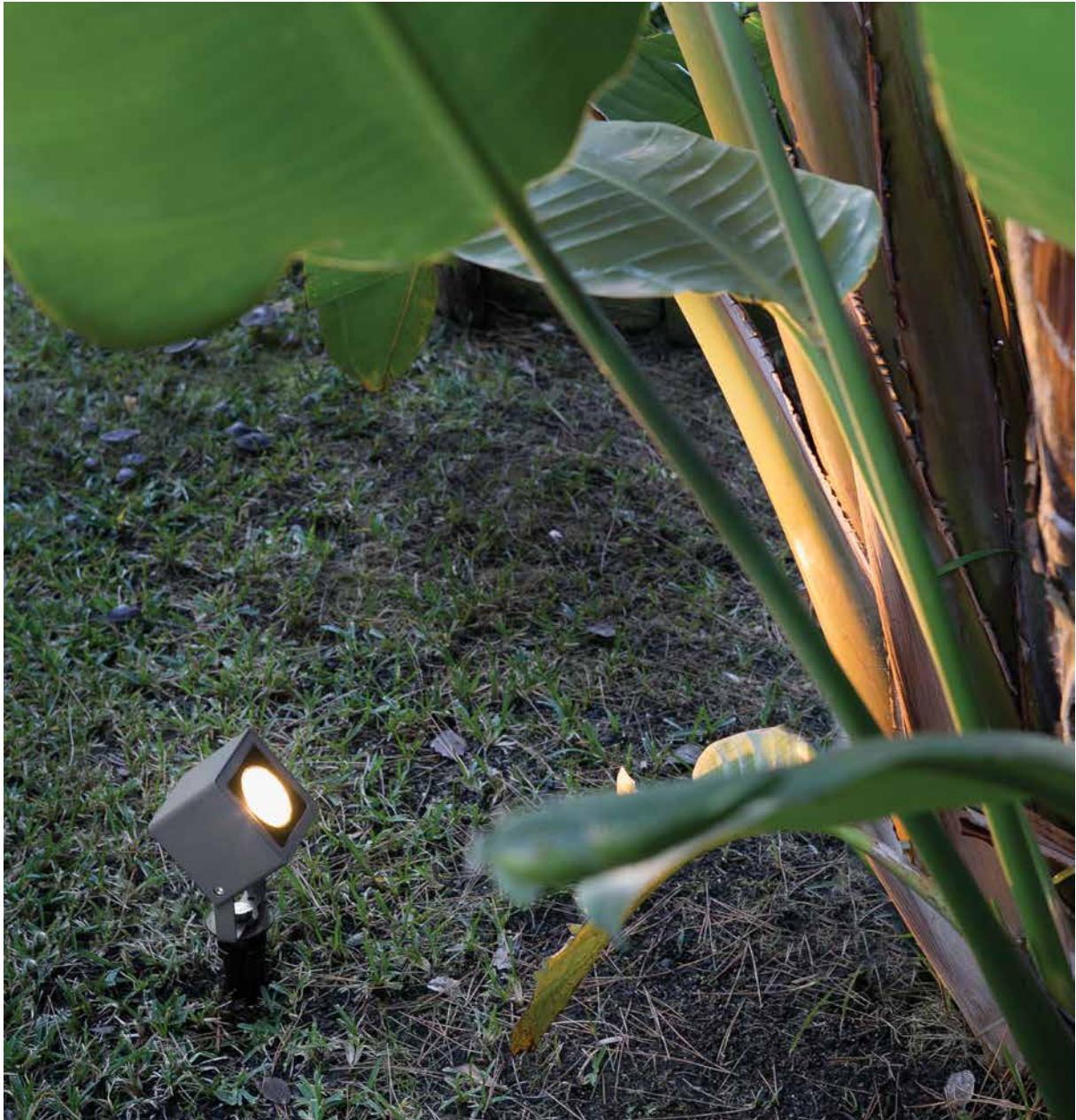

IP65

[new] **soBek**

projector/spike

70151

● black
● negro

COB LED 7W 3000K 550LM CRI>80 DRIVER INCL.

DIE CAST ALUMINIUM+TRANSPARENT GLASS/
ALUMINIO+CRISTAL TRANSPARENTE

A+ / 100-240V ~ 50-60 Hz / 0.67 kg/1.48 lb

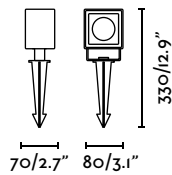

IP67

[new] baLder projector/spike

70469  black negro

SMD LED 3W 3000K 110LM CRI>80 INCL. DRIVER INCL.

ALUMINIUM+TRANSPARENT GLASS/
ALUMINIO+CRISTAL TRANSPARENTE

A / 100-240V ~ 50-60 Hz / 0.45 kg/0.99 lb

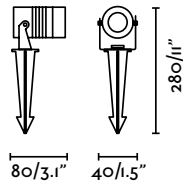

[new] sEth spike

70226  black negro

SMD LED 6W 2700K 450LM CRI>80 INCL. DRIVER INCL.

ALUMINIUM+PMMA/
ALUMINIO+PMMA

A+ / 220-240V ~ 50-60 Hz / 0.73 kg/1.61 lb





gaRda projector/spike

70131

● dark grey
● gris oscuro

HIGH POWER LED 3W 3000K 224 LM INCL. DRIVER INCL.

DIE CAST ALUMINIUM+TRANSPARENT GLASS/
ALUMINIO INYECTADO+CRISTAL TRANSPARENTE

A++ to E / 220-240V ~ 50-60 Hz / 0.78 kg/1.72 lb

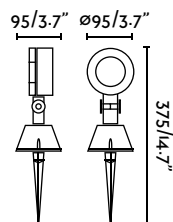

nEbel

projector/spike

70524



grey
gris

HIGH POWER LED 3W 7000K 200LM INCL. DRIVER INCL.

DIE CAST ALUMINIUM/
ALUMINIO INYECTADO

A++ to B / 220-240V ~ 50-60 Hz / 0.45 kg/0.99 lb

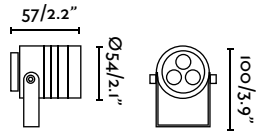

Spike accessory
 Estaca accesorio

70525



black
negro

DIE CAST ALUMINIUM/
ALUMINIO INYECTADO

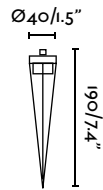

IP65

LED-9

projector/spike

70535

black | green led 600K
negro | led verde

70468

black | white led 4000K
negro | led blanco

LED 4W 4000K 140LM INCL. DRIVER INCL.

DIE CAST ALUMINIUM+TRANSPARENT GLASS/
ALUMINIO INYECTADO+CRISTAL TRANSPARENTE

A / 100-240V ~ 50-60 Hz / 0.8 kg/1.76 lb

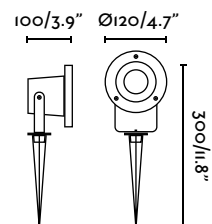

garTen-1

spike

73100



HEAT-RESISTANT ABS/
ABS TERMORESISTENTE

100-240V ~ 50-60 Hz / 0.67 kg/1.48 lb

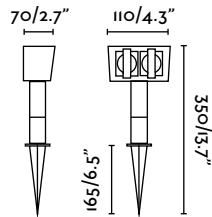

garTen-4

spike

73111



1 X E27 PAR 38 20W NOT INCL. [16285] [LED I7400]

HEAT-RESISTANT ABS/
ABS TERMORESISTENTE

B / 100-240V ~ 50-60 Hz / 0.55 kg/1.21 lb

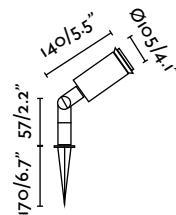
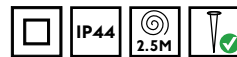

garTen-2

projector

73101



1 X E27 PAR 38 MAX 80W NOT INCL. [16285] [LED I7400]

HEAT-RESISTANT ABS/
ABS TERMO-RESISTENTE

B / 100-240V ~ 50-60 Hz / 0.26 kg/0.57 lb

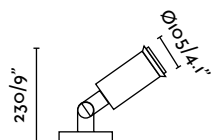
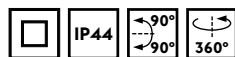



BLISTER

garTen

spike

73103



black
negro

1 X E27 PAR 38 20W INCL. [16285] [LED I7400]

HEAT-RESISTANT ABS/
ABS TERMO-RESISTENTE

A++ to E / 100-240V ~ 50-60 Hz / 0.97 kg/2.14 lb

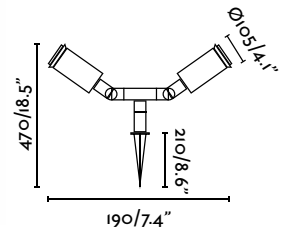
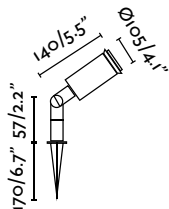
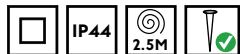

garTen-5

spike

73112



black
negro

2 X E27 PAR 38 MAX 80W NOT INCL. [16285] [LED I7400]

HEAT-RESISTANT ABS/
ABS TERMO-RESISTENTE

B / 100-240V ~ 50-60 Hz / 0.8 kg/1.76 lb

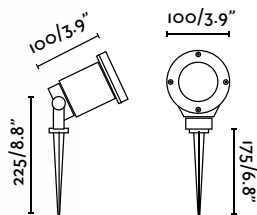
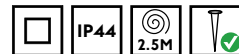

tOno

projector/spike

73150



black
negro

1 X GU10 50W INCL. [14141] [LED I4141]

DIE CAST ALUMINIUM+TRANSPARENT GLASS/
ALUMINIO INYECTADO+CRISTAL TRANSPARENTE

A / 220-240V ~ 50-60 Hz / 0.8 kg/1.76 lb

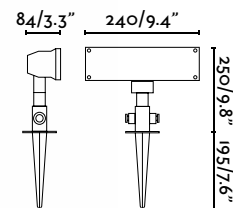
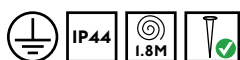

sPike

spike

73118



black
negro

1 X PL G23 I3W INCL. GEAR INCL.







PVC

A++ to A / 220-230V ~ 50 Hz / 0.88 kg/1.94 lb



special luminaries

luminarias especiales/autres luminaires/lampade speciali

	balda	259
	boo [new]	258
	ledstrip	260
	nuk	256
	stein	259
	versus	254

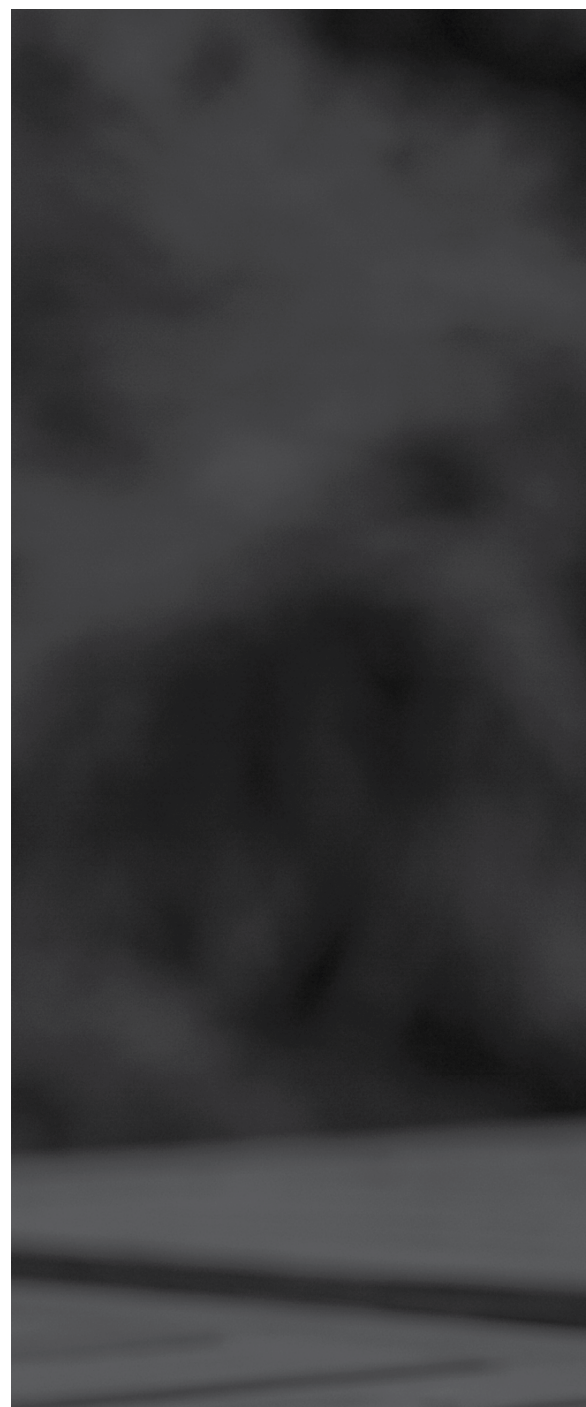



SPECIAL LUMINARIES

special luminaries
luminarias especiales
autres luminaires
lampade speciali



veRsus

by Pepe Lladet

Simple, easily-integrated and versatile. A contemporary object with a classic geometrical design formed from two conical elements.

Simple, integrable y versátil. Objeto contemporáneo y de geometría clásica que se forma a partir de dos elementos cónicos.

Simple, facile à intégrer et polyvalent. Objet contemporain à la géométrie classique composé de deux éléments coniques.



MADE IN SPAIN
HECHO EN ESPAÑA

table lamp

74423

white
blanco

1XE27 20W NOT INCL. [16167]

PEMD/
PEMD

A++ to B / 100-240V ~ 50-60 Hz / 4.1 kg/9.04 lb



Ø500/19.68"

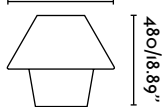

Ø240/9.44"



structure

74422 ● black negro

74424 ● black negro

STEEL/
ACERO
14 kg/30.86 lb

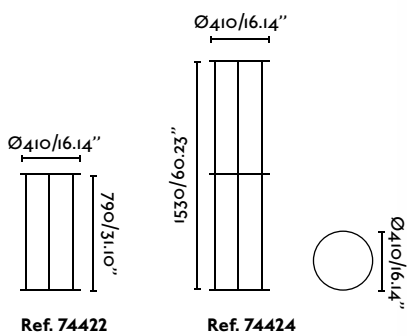

special luminaries
luminarias especiales
autres luminaires
lampe special

nUk

by Manel Llusçà

Relaxation and enjoyment come with nuk, a highly decorative portable lamp. Intended to fully enjoy life in the outdoors.



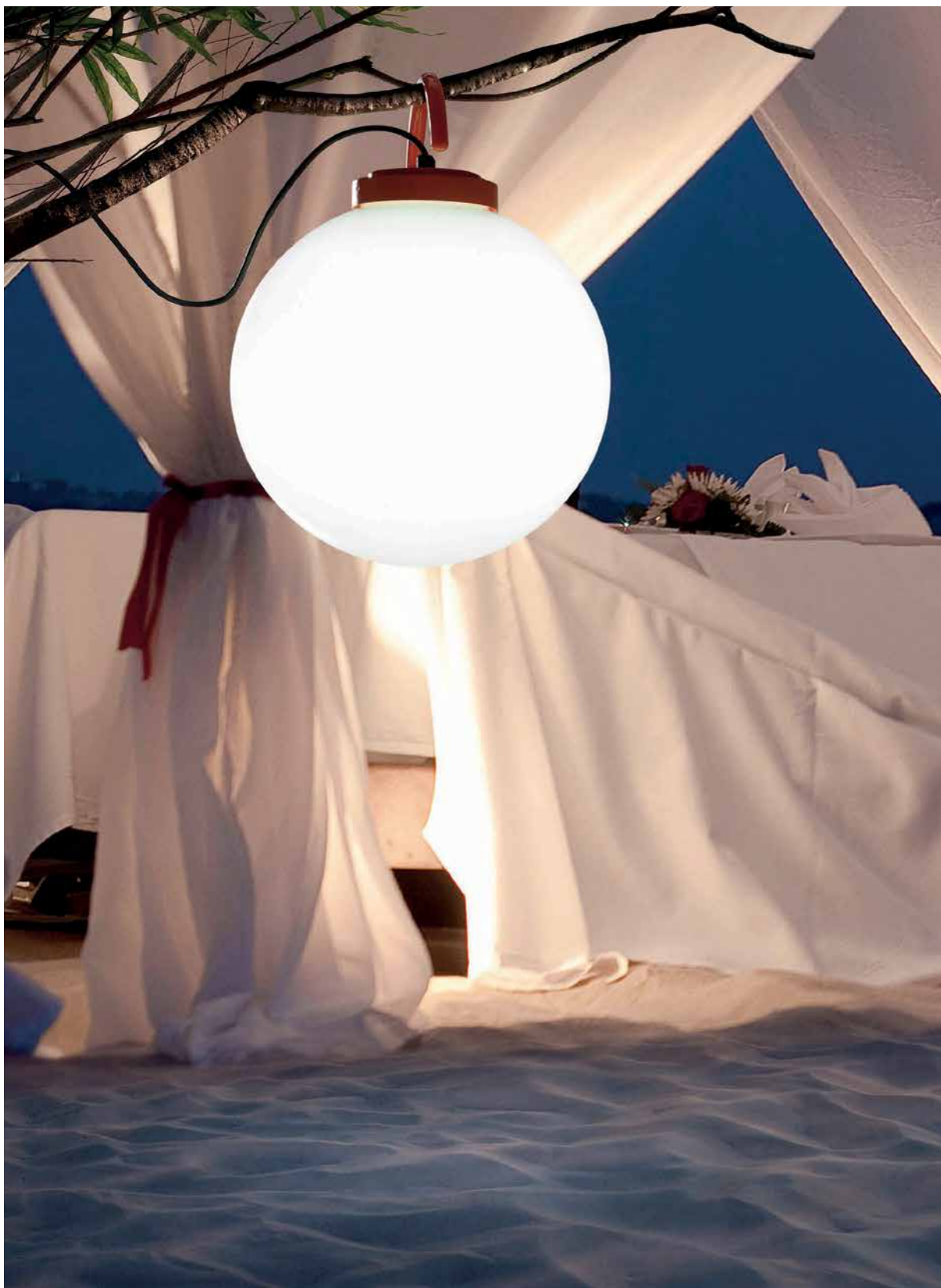

Llega la distensión y el disfrute de la mano de nuk, una lámpara portátil altamente decorativa pensada para disfrutar plenamente de la vida en el exterior.

La détente et le plaisir viennent de la main de nuk, une lampe très décoratif portable destiné à profiter pleinement de la vie en extérieur.





portable

- 70484**  orange
naranja
- 70485**  green
verde
- 70486**  grey
gris
- 70487**  fuchsia
fúcsia

1XE27 MAX 60W NOT INCL. [I6467] [LED I7203]

PMMA

A+++ to E / 100-240V ~ 50-60 Hz / 0.6 kg/1.32 lb

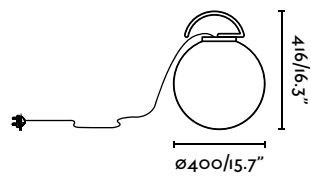



BATTERY NOT INCL. 4xAA TOUCH LAMP
 PILAS NO INCLUIDAS 4xAA LÁMPARA TÁCTIL

[new] **bOo**
portable

70492

○ white
 blanco

LED 3W 3000K INCL.

OPAL ABS/
 ABS OPAL

6V / 0.35 kg/0.77 lb

⚡ IP44

252/9.9"
 105/4.1"



ERGONOMIC

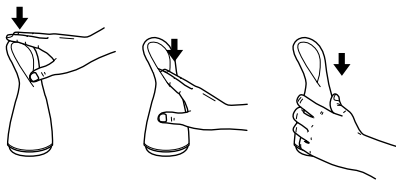

DIMMABLE 3 INTENSITIES
 DIMABLE 3 INTENSIDADES



IP65

sTein

portable

70750



white
blanco

HF

2XE27 15W NOT INCL. [16466] [LED 17059]

OPAL POLYETHYLENE/
POLIETILENO OPAL

A++ to B / 100-240V ~ 50-60 Hz / 3.3 kg/7.28 lb

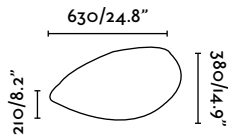

HF

Until stock exhaustion
Hasta final de stock
Jusqu'à la fin de stock



IP65

balDa

portable

70498



white
blanco

70499



white
blanco

1XE27 15W NOT INCL. [16592] [LED 17203]

OPAL POLYETHYLENE/
POLIETILENO OPAL

A++ to B / 100-240V ~ 50-60 Hz / 2 kg/4.41 lb

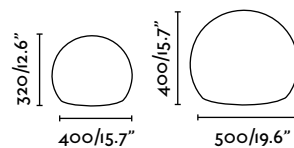

Ref. 70498

Ref. 70499

special luminaries
luminarias especiales
autres luminaires
lampe special



BLISTER

19026

LED 4,8W INCL. DRIVER INCL.

PCB

A++ to B / 220-240V ~ 50-60 Hz / 0.19 kg/0.42 lb



19027

LED 9,6W INCL. DRIVER INCL.

PCB

A++ to B / 220-240V ~ 50-60 Hz / 0.22 kg/0.49 lb



IP65

[new]

19028



warm white
blanco cálido 3000K 1350Lm

[new]

19029



cold white
blanco frío 5000K 1550Lm

LED 36W 24VDC

A++ to B / 220-240V ~ 50-60 Hz / 0.35 kg/0.77 lb

[new]

19030



LED RGB 36W 24VDC RGB

A++ to B / 220-240V ~ 50-60 Hz / 0.35 kg/0.77 lb



30LED/MT 30LED/MT

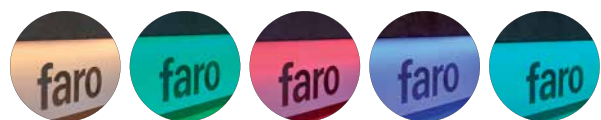

All LED accessories are easy to connect. Los accesorios para las tiras LED de interior y exterior se unen fácilmente gracias a sus interconectores.



Accessories and driver not included. Equipo y accesorios no incluidos.



POWER SUPPLY
FUENTE DE ALIMENTACIÓN

19031

100-240 V AC 36W 3A 12V DC

A++ to B / 220-240V ~ 50-60 Hz / 0.38 kg/0.84 lb



REMOTE CONTROL
MANDO A DISTANCIA

19032



RGB
RGB

A++ to B / 220-240V ~ 50-60 Hz / 0.07 kg/0.15 lb



CONECTOR WITH CABLE
CONECTOR CON CABLE

19036

MONOCOLOR

19037



RGB
RGB



CONECTOR WITH JACK
CONECTOR CON JACK

19034

MONOCOLOR

19035



RGB
RGB



CONECTOR
CONECTOR

19038

MONOCOLOR

19039



RGB
RGB



Al utilizar los accesorios, las tiras de led pierden el ip
With the accessories, led strips lose the ip.
Les bandes de led perdent leur ip avec les accessoires.

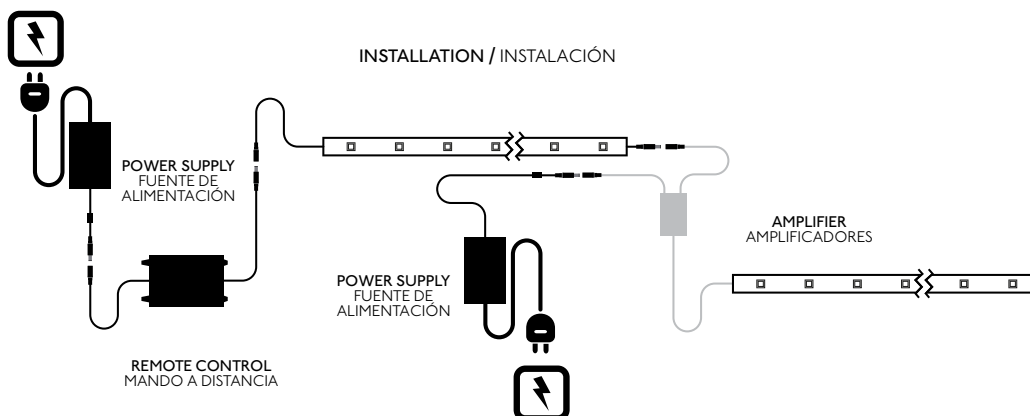

ACCES SORTES





TRANSFORMER
TRANSFORMADOR

43070

60W

A++ to B / 220-240V ~ 50/60 Hz / 0.14 kg/0.31 lb



POWER SUPPLY
FUENTE DE ALIMENTACIÓN

19031

100-240 V AC 36W 3A 12V DC

A++ to B / 220-240V ~ 50/60 Hz / 0.38 kg/0.84 lb



DRIVER
DRIVER

46060 3W

46061 350 mA 16W

A++ to B / 220-240V ~ 50/60 Hz / 0.07 kg/0.15 lb



REMOTE CONTROL
MANDO A DISTANCIA

19032



RGB
RGB

A++ to B / 220-240V ~ 50/60 Hz / 0.07 kg/0.15 lb



RECEPTOR
RECEPTOR

70475

IR RGB

A++ to B / 220-240V ~ 50/60 Hz / 0.38 kg/0.84 lb



SLAVE LED RGB CONTROLLER
CONTROLADOR SLAVE LED RGB

70476

24V / 72W

A++ to B / 220-240V ~ 50/60 Hz / 0.38 kg/0.84 lb



MAGNETIC GEAR ELT 50W
EQUIPO MAGNÉTICO ELT 50W

98101050

A++ to B / 220-240V ~ 50/60 Hz / 0.38 kg/0.84 lb



SENSOR
SENSOR

73115  white
blanco

73116  black
negro

MAX 800W

PVC/
PVC

A++ to B / 220-240V ~ 50/60 Hz / 0.38 kg/0.84 lb

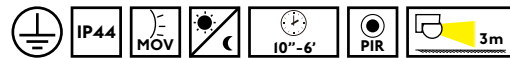

Detection angle: Maximum 120°
Ángulo de detección: Máximo 120°

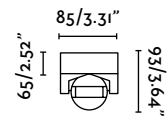

RECESSED BOC FOR LISO AND ESCA
CAJA DE EMPOTRAR PARA LISO Y ESCA

71482  dark grey
gris oscuro

PVC/
PVC

A++ to B / 220-240V ~ 50/60 Hz / 0.38 kg/0.84 lb

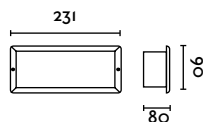

INFOR MATION



**ENG****faro** Barcelona Technical Laboratory

Faro Barcelona has extended the capacity of its Quality Control Department by equipping its laboratory with machinery that can conduct the following tests:

- IP Tests
- Incandescent thread.
- Electric shocks.
- Thermal and mechanical resistance.
- Impacts.
- Consumption and power factors.

Thanks to these advances, Faro Barcelona has raised the bar regarding the thoroughness of its tests and ensures that European regulations and standards are complied with fully.

Faro collaborates on improvements to the environment

With its commitment to efficient light bulbs and its contribution to energy saving and the campaign against global warming.

In Faro catalogues, next to the standard-use light bulb given for each item, you will see the recommended low-energy light bulb, highlighted by this symbol: [ref.] [LED ref.]

ESLaboratorio técnico propio de **faro** Barcelona

Faro Barcelona ha ampliado la capacidad de su Departamento de Control de Calidad, dotando su laboratorio de una maquinaria capaz de hacer los siguientes ensayos:

- Pruebas de IP
- Hilo incandescente.
- Choques eléctricos.
- Resistencia térmica y mecánica.
- Choques de impacto.
- Consumos y factores de potencia.

Gracias a estos avances, Faro Barcelona eleva el nivel de rigurosidad en sus ensayos y garantiza el estricto cumplimiento de las normativas y estándares europeos.

Faro colabora en la mejora del medio ambiente

Apostando por las bombillas eficientes y contribuyendo con el ahorro energético y la lucha contra el calentamiento global.

En los catálogos Faro podrá encontrar junto a la bombilla de uso standard de cada artículo cual es la bombilla de bajo consumo que recomendamos y lo diferenciamos con este símbolo: [ref.] [LED ref.]

FRLaboratoire technique appartenant à **faro** Barcelona

Faro Barcelona a élargi la capacité de son Département de contrôle qualité, en dotant son laboratoire de machines capables de procéder aux essais suivants:

- Essais d'IP
- Fil incandescent.
- Chocs électriques.
- Résistance thermique et mécanique.
- Chocs d'impact.
- Consommations et facteurs de puissance.

Grâce à ces avancées, Faro Barcelona élève le niveau de rigueur de ses essais et garantit le strict respect des réglementations et normes européennes.

Faro participe à l'amélioration de l'environnement

En misant sur des ampoules efficaces, en contribuant aux économies d'énergie et en participant à la lutte contre le réchauffement de la planète.

Dans les catalogues Faro, vous trouverez, à côté de l'ampoule standard utilisée pour chaque article, l'ampoule basse consommation recommandée et identifiée par ce symbole: [réf.] [LED réf.]

PTLaboratório técnico próprio da **faro** Barcelona

A Faro Barcelona ampliou a capacidade do seu Departamento de Controlo de Qualidade, dotando o seu laboratório de uma maquinaria capaz de fazer os seguintes ensaios:

- Testes de IP
- Fio incandescente.
- Choques eléctricos.
- Resistência térmica e mecânica.
- Choques de impacto.
- Consumos e factores de potência.

Graças a estes avanços, a Faro Barcelona eleva o nível de rigor nos seus ensaios e garante o estrito cumprimento das normas e padrões europeus.

A Faro colabora na melhoria do meio ambiente

Apostando nas lâmpadas eficientes e contribuindo para a poupança energética e para a luta contra o aquecimento global.

Nos catálogos Faro poderá encontrar, junto à lâmpada de uso padrão de cada artigo, a lâmpada de baixo consumo recomendada e que se diferencia com este símbolo: [ref.] [LED ref.]

GEREigenes technisches Labor von **faro** Barcelona

Faro Barcelona hat die Leistungsfähigkeit seiner Qualitätssicherungsabteilung durch die Ausstattung seines Labors mit Einrichtungen für folgende Tests erweitert.

- IP-Tests
- Thermische und mechanische Elektroschocks Widerstandskraft
- Mechanische Stöße
- Verbrauchs- und Leistungsaspekte
- Glühfäden

Dank dieser Erweiterungen kann Faro Barcelona jetzt seine Produktprüfungen noch wesentlich rigoroser durchführen und eine strikte Erfüllung der europäischen Normen und Standards garantieren.

Faro bemüht sich ständig um den Umweltschutz

Daher verwenden wir immer mehr effiziente Leuchtmittel und tragen damit zum Einsparen von Energie und zum Kampf gegen die Klimaerwärmung bei.

In den Katalogen von Faro finden Sie neben den Standard-Leuchtmitteln für die einzelnen Artikel auch jeweils passende Sparbirnen, die mit folgendem Symbol gekennzeichnet sind: [ref.] [LED ref.]

NLEigen technisch laboratorium van **faro** Barcelona

Faro Barcelona heeft de capaciteit van haar Afdeling Kwaliteitscontrole uitgebreid met een laboratorium waarin de volgende testen kunnen worden uitgevoerd:

- Testen van de IP-code
- Gloeidraad.
- Elektrische schokken.
- Thermische en mechanische weerstand.
- Schok door impact.
- Verbruik en vermogensfactoren.

Dankzij deze vooruitgang is er bij Faro Barcelona sprake van een hoger striktheidniveau tijdens het testen en garandeert een strikte naleving van de Europese normen en standaards.

Faro werkt mee aan de verbetering van het milieu

Middels het gebruik van efficiënte lampen. Zo draagt zij bij aan de energiebesparing en aan de strijd tegen de opwarming van de aarde.

In de catalogi van Faro treft u naast de lamp voor standaardgebruik van ieder artikel de aanbevolen lamp met laag verbruik aan die met dit symbool wordt onderscheiden: [ref.] [LED ref.]

BLСобствена техническа лаборатория на **faro** Barcelona

Faro Barcelona разшири капацитета на своя Отдел за контрол на качеството, като обзаведе лабораториите си с оборудване за осъществяване на следните изпитвания:

- Изпитвания за степен на защита (IP)
- Термична и механична
- Токови удари.Сустойчивост.
- Удари в твърд предмет.
- Консумирана мощност
- Нажежена жичка. и коефициент на мощността.

По този начин Faro Barcelona повишава точността на изпитванията и гарантира стриктно спазване на европейските.

Faro съдейства за подобряване на околната среда чрез използване на енергоспестяващи крушки, с което дава своя принос в борбата с глобалното затопляне.

В каталозите на Faro всеки продукт може да се използва както със стандартна, така и с енергоспестяваща крушка, която е препоръчителна и е означена със следния символ: [спра.] [LED спра.]

PLLaboratorium techniczne należąca do **faro** Barcelona

Firma Faro Barcelona rozszerzyła zakres kompetencji swojego Działu Kontroli Jakości, wyposażając laboratorium w urządzenia wykonujące następujące testy:

- Próby IP
- Włókno żarzenia.
- Porażenia prądem.
- Wytrzymałość termiczna i mechaniczna.
- Wstrząsy.
- Zużycie i czynniki mocy.

Dzięki tym procedurom firma Faro Barcelona zaostrzyła poziom testów, gwarantując bezwzględne przestrzeganie norm i standardów europejskich.

Firma Faro chroni środowisko**Stawiając na wydajne żarówki i oszczędność energii, przyczyniając się tym samym do walki z globalnym ociepleniem.**

Oprócz informacji o standardowych żarówkach, katalogi Faro zawierają zalecenia dotyczące żarówek energooszczędnych wyróżnione tym symbolem: [odni.] [LED odni.]



I

Laboratorio tecnico proprio di faro Barcelona

Faro Barcellona ha ampliato la capacità del suo Dipartimento di Controllo della Qualità, dotando il suo laboratorio di macchinari in grado di realizzare i seguenti test:

- Prove di IP
- Filo incandescente.
- Scariche elettriche.
- Resistenza termica e meccanica.
- Test di impatto.
- Consumi e fattori di potenza.

Grazie a questi progressi, Faro Barcelona alza il livello di rigidità nei suoi test e garantisce il rigido rispetto delle normative e degli standard europei.

Faro collabora al miglioramento dell'ambiente

Scommettendo sulle lampadine efficienti e contribuendo al risparmio energetico e alla lotta contro il riscaldamento globale. Nei cataloghi Faro potrete trovare, assieme alla lampadina d'uso standard di ogni articolo, la lampadina di basso consumo consigliata e che si distingue con questo simbolo: [rif.] [LED rif.]

GRK

faro Barcelona Technical Laboratory

Η Faro Barcelona έχει διευρύνει τις δυνατότητες του Τμήματος Ελέγχου Ποιότητας, εξοπλίζοντας το εργαστήριό της με μηχανήματα που πραγματοποιούν τα εξής test:

- Τεστ IP
- Νήμα πυρακτώσεως.
- Ηλεκτροπληξία.
- Θερμική και μηχανική αντοχή.
- Κρούση.
- Κατανάλωση και παράγοντες ισχύος.

Χάρη σε αυτές τις εξελίξεις, η Faro Barcelona αυξάνει το επίπεδο αυστηρότητας στις δοκιμές της και εξασφαλίζει την απόλυτη τήρηση των ευρωπαϊκών κανονισμών και προτύπων.

Η Faro συμβάλλει στη βελτίωση του περιβάλλοντος χρησιμοποιώντας λαμπτήρες και συμβάλλοντας στην εξοικονόμηση ενέργειας και την καταπολέμηση της υπερθέρμανσης του πλανήτη.

Στους καταλόγους της Faro μπορείτε να βρείτε, μαζί με τον συμβατικό λαμπτήρα για κάθε προϊόν, τον συνιστώμενο λαμπτήρα χαμηλής κατανάλωσης που διακρίνεται με αυτό το σύμβολο: [αναφ.] [LED αναφ.]

RUS

Собственная техническая лаборатория компании faro Barcelona

Потенциал Отдела контроля качества компании Faro Barcelona увеличился благодаря появлению в лаборатории оборудования, с помощью которого можно проводить следующие испытания:

- Тестирование IP
- Механическое и
- Поражение электрическим током.
- Воздействие от столкновения.
- Потребление и
- Спираль накаливания. коэффициент мощности.

Благодаря этому компания Faro Barcelona предъявляет все более жесткие требования к проведению исследований и обеспечивает строгое соответствие европейским стандартам и нормам.

Faro заботится об окружающей среде делая ставку на эффективные электрические лампы, позволяющие экономить энергию и бороться с глобальным потеплением.

В каталогах Faro можно найти как стандартные лампы различных типоразмеров, так и рекомендуемые энергосберегающие лампы, отмеченные специальным символом: [ссы.] [LED ссы.]

CZ

Собственная техническая лаборатория компании faro Barcelona

Потенциал Отдела контроля качества компании Faro Barcelona увеличился благодаря появлению в лаборатории оборудования, с помощью которого можно проводить следующие испытания:

- Тестирование IP
- Механическое и
- Поражение электрическим током.
- Воздействие от столкновения.
- Потребление и
- Спираль накаливания. коэффициент мощности.

Благодаря этому компания Faro Barcelona предъявляет все более жесткие требования к проведению исследований и обеспечивает строгое соответствие европейским стандартам и нормам.

Používáním efektivních žárovek přispívá firma Faro ke zlepšení životního prostředí, úspoře elektrické energie a boji proti globálnímu oteplování.

V katalozích Faro naleznete vedle standardní žárovky vhodné pro jednotlivé zboží i doporučenou žárovku s nízkou spotřebou, která je označena tímto symbolem: [ref.] [LED ref.]

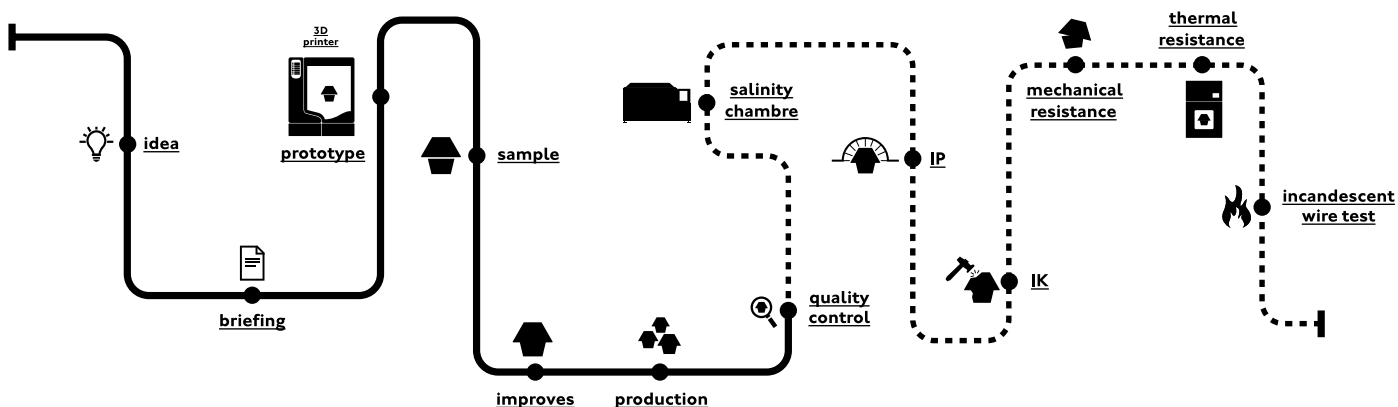

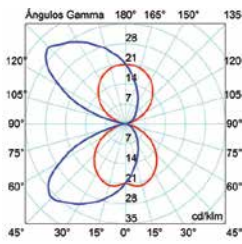

ÁNCORA
74401

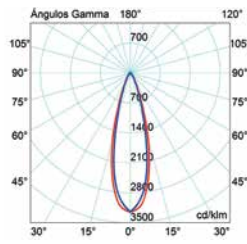

ARAL
70466

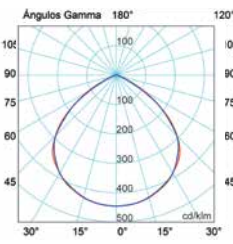

ARAN
70137

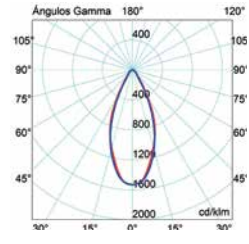

AREO
70650

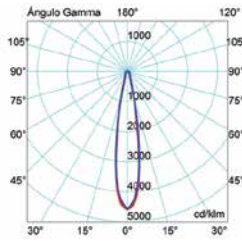

BAIKAL-1
70128

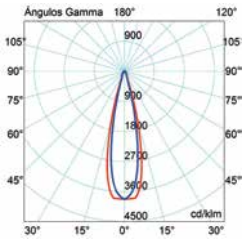

BAIKAL-2
70129

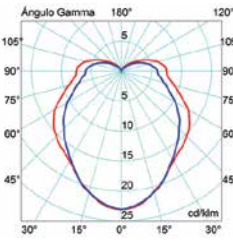

BOLETUS
74391

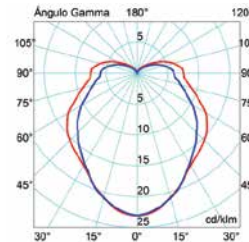

BOLETUS
74392

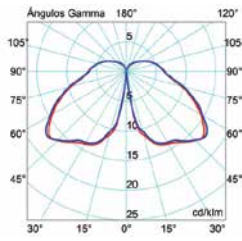

BOLETUS
74393

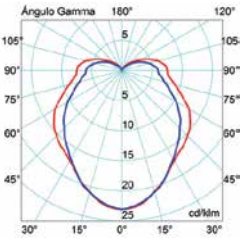

BOLETUS
74394

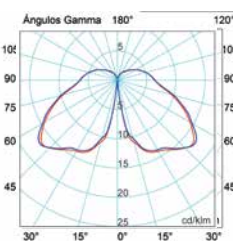

BOLETUS
74395

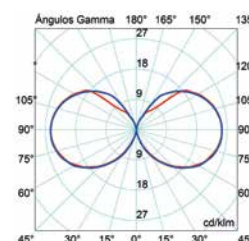

CARTAGO
73254

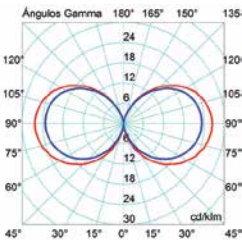

CARTAGO
73255

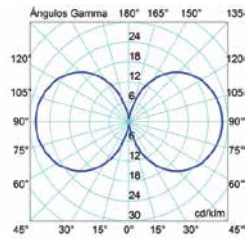

CARTAGO
73256

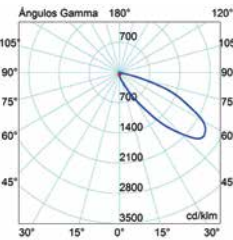

CITRUS-2
70561

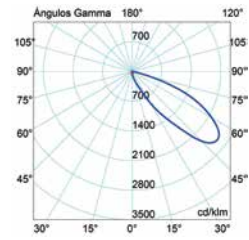

CITRUS-4
70562

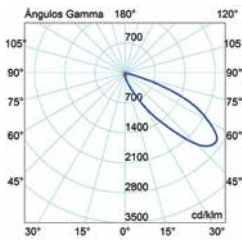

CITRUS-6
70563

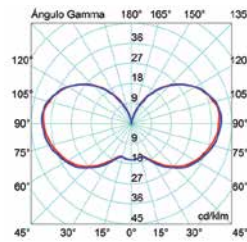

CROSS
74350

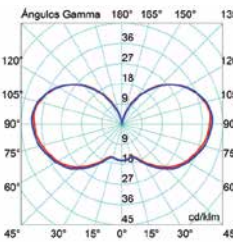

CROSS
74351

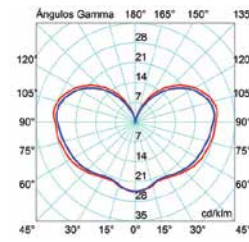

CROSS
74353

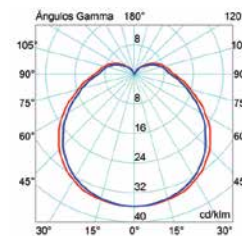

CROSS
74355

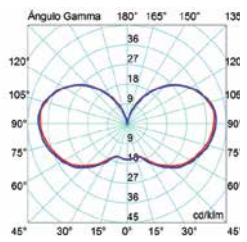

CROSS
74356 / 74357

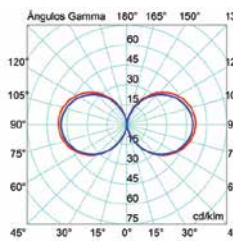

CROSS
74358

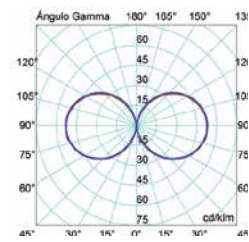

CROSS
74359

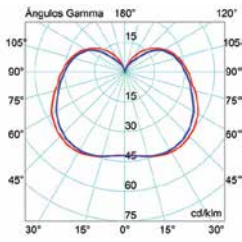

CROSS
74362

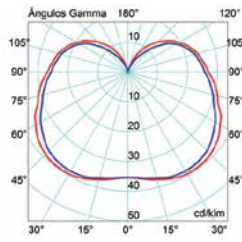

CROSS
74363

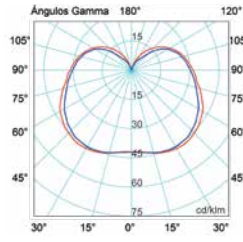

CROSS
74364

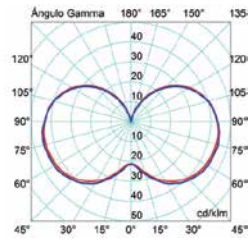

CROSS
74366

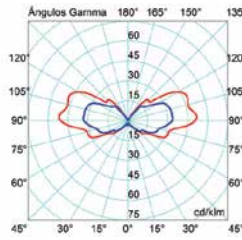

CROSS
74369

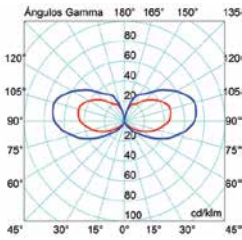

CROSS
74370

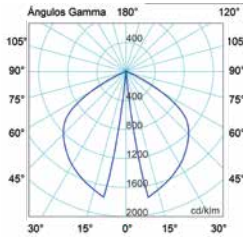

DAS
75518

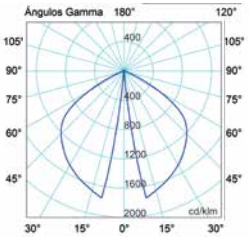

DAS
75519

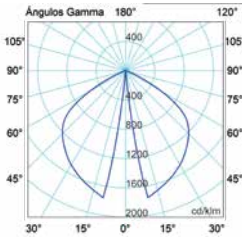

DAS
75520

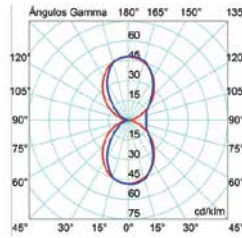

DRAGMA
71362

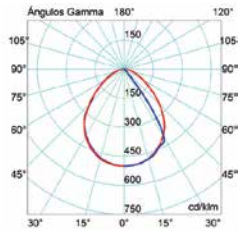

GAUSS
70516

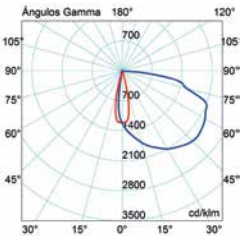

HEVIA
70926

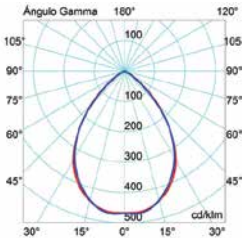

KLAMP
74407

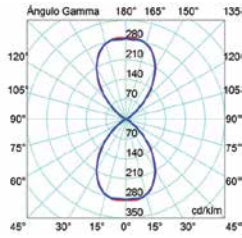

KLAMP
74408

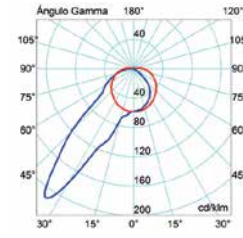

KLAMP
74409

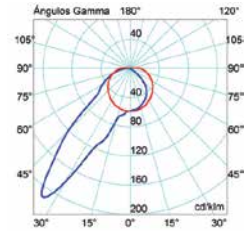

KLAMP
74410 / 74411

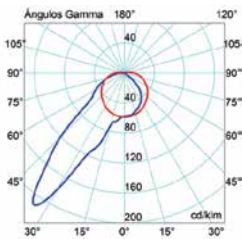

KLAMP
74412 / 74413

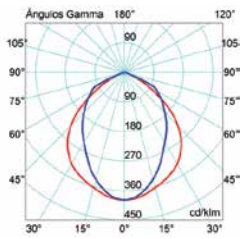

KONIC
70012

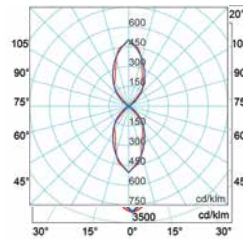

LACE
70811

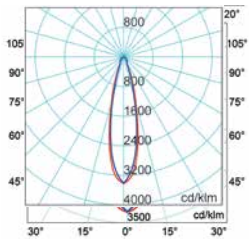

LED-9
70468

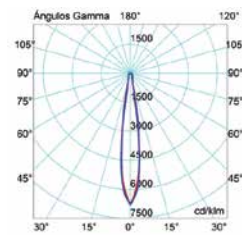

LED-13
70542

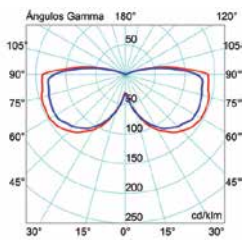

LED-15
70544

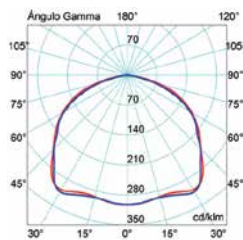

LED-16
70545

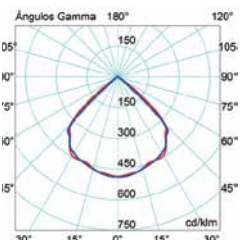

LED-18 Cuadrado
(Señalización)
71497 / 71499

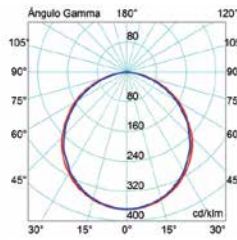

LED-18 Cuadrado (Iluminación)
71497 / 71499

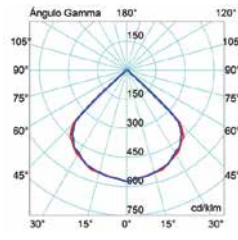

LED-18 Redondo (Señalización)
71496 / 71498

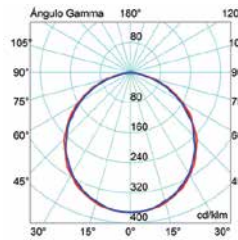

LED-18 Redondo (Iluminación)
71496 / 71498

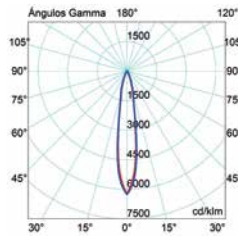

LED-19
70596 / 70597

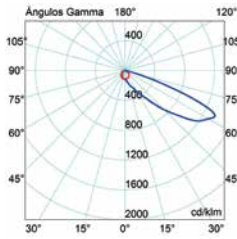

LEVA
70892

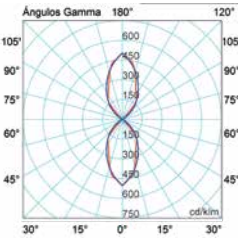

LING
70812 / 70813

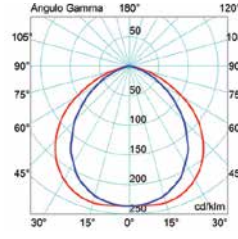

LIO
71495

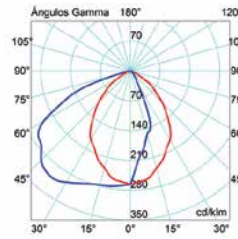

LUXSTAR-1
70016

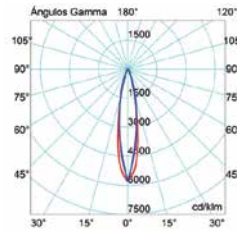

MARAT-1
70551

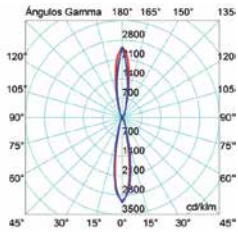

MARAT-2
70552

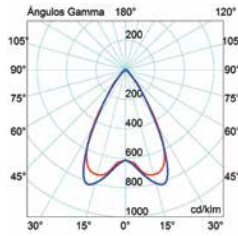

MINI-PROJECT
71383 / 71390

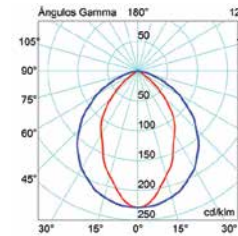

MYSORE
71476

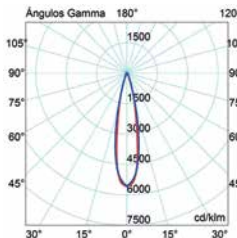

NYASA
70465

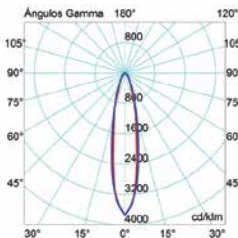

ONDA
70120

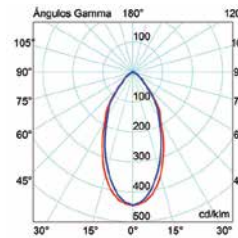

PARK-1
71391

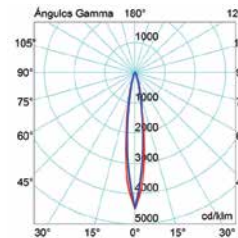

PARK-3
71393

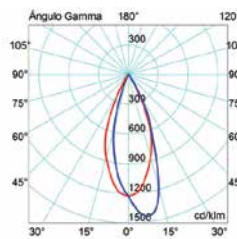

PROA
74400

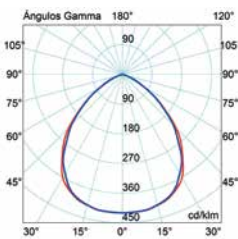

PROJECT
71382 / 71389

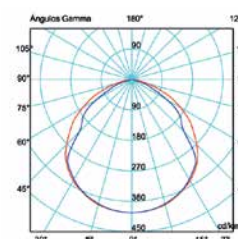

SENTINEL
75099

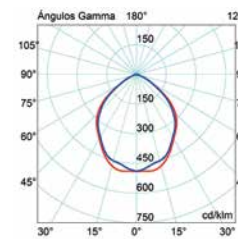

SIL
70112

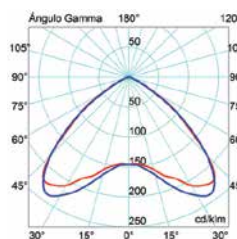

TECNO-1
71483

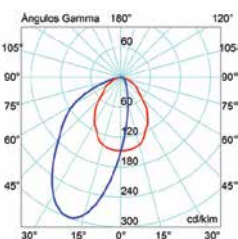

TECNO-3
71485

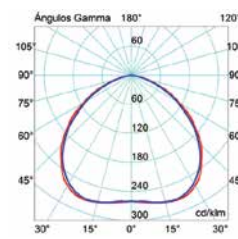

TECNO-6
71488

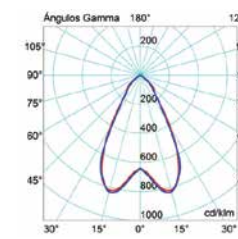

TECNO-6
71489

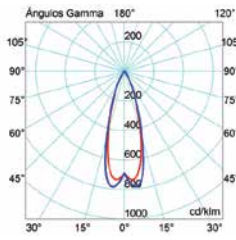

TECNO-7
71492

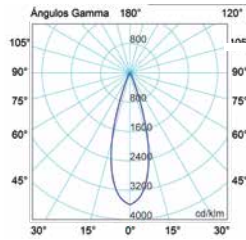

TOBA
70136

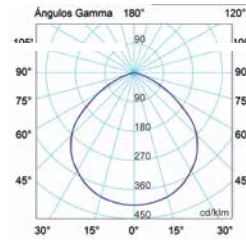

TORAN-1
70139

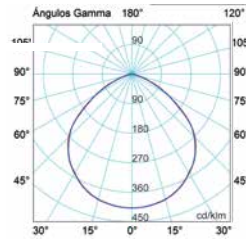

TORAN-2
70140

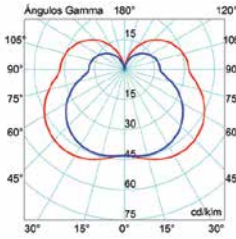

TRIAL
74380

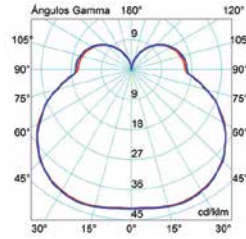

TRIAL
74381

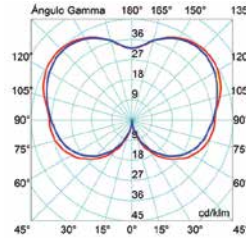

TRIAL
74382

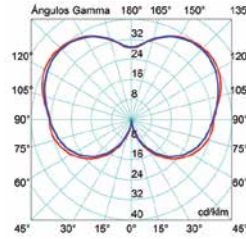

TRIAL
74384

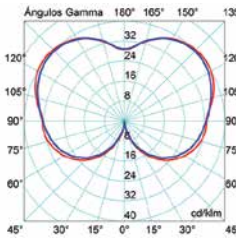

TRIAL
74385

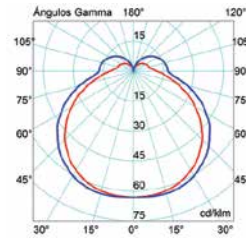

TRIAL
74386

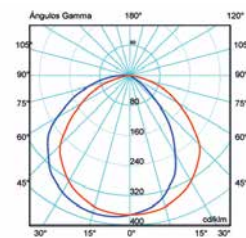

YAK
75105 / 75106

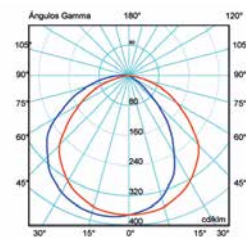

YAK
75108

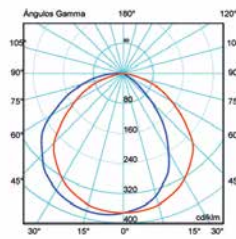

YAK
75110



	ENG	ES	FR	PT	GER	NL
	Has a protective earth Class I protection	Con toma de tierra Aislamiento clase I	Avec prise de terre Catégorie de protection I	Com ligação terra Isolamento classe I	Mit Erdung Isolierung der Klasse I	Met aardleiding Isolatie klasse I
	Reinforced or double insulation (class II protection)	Aislamiento clase II	Isolément de protection (classe de protection II)	Isolamento (clase II)	Isolierung der Klasse II	Isolatie klasse II
	Low voltage protection (class III protection)	Aislamiento clase III	Très basse tension de protection (classe protec. III)	Isolamento (clase III)	Isolierung der Klasse III (für montage auf)	Isolatie klasse III
	No incandescent bulb	No bombilla incandescente	Pas utiliser ampoule incandescence	Não use lâmpada incandescente	Nicht verwenden Glühlampe	Gebruik geen gloeilamp
	Not included Included	No incluida Incluida	Non incluse Incluse	Não incluída Incluída	Nicht eingeschlossen Eingeschlossen	Niet inbegrepen Inbegrepen
	Without shade Sockets	Sin pantalla Tomas	Sans abat-jour Prises	Sem abat jour Tomadas	Ohne Schirm Anschlüsse	Zonder scherm Aansluitingen
	Cable	Cable	Câble	Cabo	Kabel	Kabel
	Cut out	Agujero para empotrar	Trou d'encastrement	Furo para encastrar	Bohrloch zum Einbauen	Gat om in te bouwen
	Service time Charging time	Autonomía Tiempo de carga	Autonomie Temps de charge	Autonomia Tiempo de carga	Brenndauer Aufladezeit	Autonomie Herlaadtijd
	Adjustable duration time	Tiempo de ajuste	Temps de réglage	Tempo de ajuste	Einstellzeit	Afsteltijd
	Resistance in kg	Resistencia en kg	Résistance en kg	Resistência em kg	Widerstand in kg	Weerstand in kg
	Detection angle Sensor movement	Ángulo de detección -Sensor de movimiento	Angle de détection Détecteur de mouvement	Angulo de detacção -Sensor de movimento	Detektionswinkel Bewegungssensor	Beschermingshoek Bewegingssensor
	With equipment, ballast included Special transformer	Con equipo, reactancia incluida Transformador especial	Avec l'équipement, ballast inclus Transformateur spécial	Com equipamento, equipamento incluido Transformador especia	Ausrüstung, reaktanz inbegriffen Spezieller Transformator	Met uitrusting, reactancia inbegrepen Speciale transformator
	DRIVER	DRIVER	DRIVER	DRIVER	DRIVER	DRIVER
	Shock resistance	Resistencia a golpes	Résistance aux chocs	Resistência a choque	Schockfestigkeit	Schokbestendigheid
	Recessed box	caja empotrar	Boîte encastrée	Recesso box	Einbaugeschäuse	Recessed box
	Maintenance steel	Mantenimiento acero	Acier maintenance	Aço manutenção	Wartung Stahl	Onderhoud Staal
	Dimable	Dimmable	Réglable	Regulável	Dimmbar	Dimbaar
	Detector	Sensor	Détecteur	Sensor	Sensor	Sensor
	Day/night	Día/noche	Jour/nuit	Dia/noite	Nacht	Dag/nacht
	Adjustable	Orientable	Orientable	Ajustável	Verstellbar	Verstelbare
	Remote control	Mando a distancia	Télécommande	Comando à distancia	Vernbedienung	Dubbele intensiteit
	Photometric	Fotométrica	Photométrique	Fotométrico	Photometrische	Fotometrische
	Light up	Luz arriba	Lumière de haut	Luz para cima	Licht auf	Lichte omhoog
	Light down	Luz abajo	Lumière vers les bas	Luz para baixo	Licht nach unten	Licht omlaag
	Light up and down	Luz arriba y abajo	Lumière de haut en bas	Luz para cima e para baixo	Licht auf und ab	Licht boven en beneden
	Beam angle	Grados apertura	Grades halo lumineux	Notas luz	Light grade	Licht rangen
	Blister	Blister	Blister	Blister	Blister	Blister
	Underwater x mts	Sumergibles x mts	Sous-marin x mts	Debaixo d'água x mts	Unterwasser x mts	Onderwater x mts
	Spike	Estaca	Piquet	Spike	Spike	Spike
	Adjustable	Orientable	Orientable	Ajustável	Drehbar	Verstelbare



SYMBOLS/SÍMBOLOS/SYMBOLS/SIMBOLI

	I	GRK	RUS	CZ	BL	PL
	Con messa a terra Isola. tipo I	Με γείωση Μόνωση κλάσης I	С контактом заземления Изоляция класс I	S uzemněním Izolace třídy I	Със заземляване Изолация клас I	Z uziemieniem Izolacja klasy I
	Isolamento tipo II	Μόνωση κλάσης II	Изоляция класс II	Izolace třídy II	Изоляция клас II	Izolacja klasy II
	Isolamento tipo III	Μόνωση κλάσης III	Изоляция класс III	Izolace třídy III	Изоляция клас III	Izolacja klasy III
	Non lampadina a incandescenza	Δεν λάμπα πυρακτώσεως	нет накаливания	No žárovka	не крушка с нажежаема жичка	żarówka nie używać
	Non inclusa Inclusa	Δεν συμπεριλαμβάνεται συμπεριλαμβάνεται	Не включена включена	Není přiložena Přiložena	Не е включена Включена	Nie dołączono Dołączono
	Senza paralume Prese	Χωρίς καπέλο Πρίζες	Без экрана Розетки	Bez obrazovky/přívodů	Без екран/контакти	Bez ekranu/gniazdek
	Cavo	Καλώδιο	кабель	kabel	кабел	kabel
	Foro per incasso	Οπή για εντοίχιση	Отверстие для встраивания	Otvor k vložení	Μонтажен отвор	Otwór do mocowania
	Autonomia Tiempo de carga	Αυτονομία Χρόνος επαναφόρτισης	Длительность работы Время зарядки	Výdrž - doba nabíjení	Време за автономна работа време за зареждане	Zakres czasu ładowania
	Tempo di regolazione	Χρόνος προσαρμογής	Время регулировки	Čas seřízení	Време за настройка	Czas regulacji
	Resistenza in kig	Ανθεκτικότητα σε κιλά	Сопротивление в килограммах	Odolnost v kg	Устойчивост в килограми	Wytrzymałość w kilo
	Angolo di rilevamento - Sensore movimento	Γωνία ανίχνευσης Αισθητήρας κίνησης	Угол обнаружения Датчик движения	Detekční úhel / senzor pohybu	Ъглов обхват / сензор за движение	Kąt wykrywania/czujnik ruchu
	Con attrezzatura reattanza inclusa Trasformatore speciale	Με εξοπλισμό Συμπεριλαμβάνεται αντίσταση Ειδικός μετασχηματιστής	С оборудованием сопротивление включено Специальный трансформатор	Včetně zařízení reaktance Speciální transformátor	С оборудване включено съпротивление Специален трансформатор	Zestaw reakcancji w komplecie Specjalny transformator
	DRIVER	DRIVER	DRIVER	DRIVER	DRIVER	DRIVER
	Resistenza agli urti	Σοκ αντίσταση	Ударопрочность	Odolnost proti rázům	Шоково съпротивление	Odporność na wstrząsy
	Incasso box	χωνευτα κουτι	Монтажная коробка	Recessed box	за вграждане box	Puszka
	Manutenzione in acciaio	Χάλυβα Συντήρηση	Техническое обслуживание сталь	Údržba ocel	Поддръжка стомана	Stali Konserwacja
	Regolabile	ροοστάτη	затемняемый	Stmívatelné	димиране	ściemniania
	Sensor	Αισθητήρας	Датчик	Senzor	Сензор	Czujnik
	Giorno/notte	День/Ночь	Нjмjра – vчjхта	Den/noc	Ден/ноц	Dzień/noc
	Regolabile	ρυθμιζόμενο	Регулируемый	Nastavitelný	Регулируеми	Orientacja
	Doppia intensità	Τηλεχειριστήριο	Дистанционное управление	Dálkové ovládání	Дистанционно управление	Zdalne sterowanie
	Fotometrica	φωτομετρικός	фотометрический	Fotometrické	Фотометрично	Fotometryczny
	Luce su	φως εγγραφη	Свет вверх	Osvětlit	лайт нагоре	Zapalać się
	Luce giù	φως κάτω	Свет вниз	Světlo dolů	лайт надолу	Światło w dół
	Luce su e giù	φως εγγραφη και κάτω	Свет вверх и вниз	Světlo nahoru a dolů	лайт нагоре и надолу	Światło w górę iw dół
	Gradi di luce	φως βαθμών	Светлые сорта	Světlo třídy	Светлинни марки	Lekkie klasy
	Blister	Blister	Blister	Blistr	блистер	Blister
	Subacquea x mts	Υποβρυχια x mts	подводный x мтс	Pod vodou x mts	подводни x mts	x mts podwodne
	Picco	Spike	Спайк	Spike	Спайк	Spike
	Regolabile	ρυθμιζόμενο	Регулируемый	Nastavitelný	Регулируеми	Orientacja



MATERIALS/MATERIALES/MATÉRIAUX/ MATERIALI















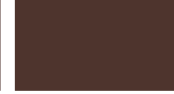











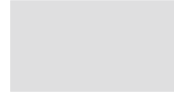

	<u>ES</u>	<u>FR</u>	<u>PT</u>	<u>GER</u>	<u>NL</u>	<u>I</u>
ABS	ABS	ABS	ABS	ABS	ABS	ABS
ALUMINIUM	Aluminio	Aluminium	Alumínio	Aluminium	Aluminium	Alluminio
BEVELED GLASS	Cristal biselado	Verre biseauté	Vidro biselado	Abgeschrägtes Glas	Schuine glas	Vetro smussato
BUBBLE GLASS	Cristal burbuja	Verre bullé	Vidro bolha	Blasenglas	Bubble glas	Vetro bolla
BRASS	Latón	Laiton	Bronze	Messing	Messing	ottone
DIE CAST ALUMINIUM	Aluminio inyectado	Fonte d'aluminium	Alumínio fundido	Aluminiumguss	Gegoten aluminium	Ghisa alluminio
GLASS	Cristal	Verre	Vidro	Glas	Glas	Vetro
HEAT-RESISTANT ABS	ABS resistente al calor	ABS Résistant à la chaleur	ABS Resistente ao calor	Hitzebeständige ABS	Hittebestendig ABS	ABS Resistente al calore
METAL	Metal	Métal	Metal	Metall	Metaal	Metallo
OPAL ACRYLIC	Acrílico opal	Acrylique opale	Opal acrílico	Opalacryl	Opaal acrylaat	Acrilico opale
OPAL GLASS	Cristal opal	Verre opale	Vidro opal	Opalglas	Opaal glas	Vetro opalino
OPAL PMMA	PMMA opale	PMMA opale	PMMA opal	Opal PMMA	Opaal PMMA	PMMA opale
OPAL POLYCARBONATE	Policarbonato opal	Polycarbonate opale	Policar-bonato opal	Opal polycarbonat	Opaal polycarbonnat	Policar-bonato opale
OPAL POLYETHYLENE	Poliétileno opal	Polyéthylène opale	Poliétileno opal	Polyethylen opal	Polyethyleen opaal	Poliétilene opale
OPAL PVC	Opal PVC	PVC opale	PVC opal	Opal PVC	Opaal PVC	PVC opale
OPTICAL GLASS	Cristal óptico	Verre optique	Vidro óptico	Optisches Glas	Optisch glas	Vetro ottico
PEMD	PEMD	PEMD	PEMD	PEMD	PEMD	PEMD
PMMA	PMMA	PMMA	PMMA	PMMA	PMMA	PMMA
POLYCARBONATE	Policarbonato	Polycarbonate	Policarbonato	Polycarbonat	Polycarbonaat	Policarbonato
PVC	PVC	PVC	PVC	PVC	PVC	PVC
RUSTIC GLASS	Cristal rústico	Verre rustique	Vidro rústico	Rustikale Glass	Rustieke Glass	Vetro rustico
STAINLESS STEEL	Acero inoxidable	Acier inoxydable	Aço inoxidável	Edelstahl Rostfreier	Roestvrij staal	Acciaio inossi.
STEEL	Acero	Acier	Aço	Stahl	Staal	Acciaio
TEMPERED GLASS	Cristal templado	Verre trempé	Vidro temperado	Gehärtetes Glas	Gehard glas	Vetro temperato
TEMPERED TRANSPARENT GLASS	Cristal transparente templado	Verre trempé transparent	Vidro transparente temperado	Gehärtetes Glas transparent	Gehard transparant glas	Vetro temperato trasparente
TRANSLUCENT GLASS	Cristal translúcido	Verre translucide	Vidro translúcido	Translucent Glas	Doorschijnend glas	Vetro traslucido
TRANSLUCENT POLYCARBONATE	Policarbonato translúcido	Polycarbonate translucide	Policar-bonato transl.	Translucent polycarbonat	Doorschijnend polycarbo.	Policar-bonato transl.
TRANSLUCENT PVC	PVC translúcido	PVC translucide	PVC translúcido	Translucent PVC	Doorschijnend PVC	PVC traslucido
TRANSPARENT GLASS	Cristal transparente	Verre transparent	Vidro transpa.	Transparentem Glas	Transparant glas	Vetro trasparente
TRANSPARENT POLYCARBONATE	Policarbonato transparente	Polycarbonate transparent	Policarbonato transparente	Transparent polycarbonat	Transparant polycarbonaat	Policarbonato trasparente
TRANSPARENT PVC	PVC transparente	PVC transparent	PVC transp.	Transparentes PVC	Transparant PVC	PVC transp.



MATERIALS/MATERIALES/MATÉRIAUX/ MATERIALI

	<u>GRK</u>	<u>RUS</u>	<u>CZ</u>	<u>BL</u>	<u>PL</u>
ABS	ABS	ABS	ABS	ABS	ABS
ALUMINIUM	Αλουμίνιο	Алюминий	Hliník	Алюминий	Aluminium
BEVELED GLASS	λοξότμητη γυαλί	Скошенные стекла	Zkosené sklo	Beveled стъкло	Fazowane szkło
BUBBLE GLASS	Γυαλί φούσκα	Бузырь стекло	Bublina sklo	балон стъкло	Szklane bańki
BRASS	ορείχαλκος	латунь	mosaz	месинг	mosiądz
DIE CAST ALUMINIUM	Χυτό αλουμίνιο	Ритого алюминия	Z litého hliníku	Рят алуμινий	Odlw aluminium
GLASS	Γυαλί	Стекло	Sklo	Стъкло	Szkło
HEAT-RESISTANT ABS	Ανθεκτικά στη θερμότητα ABS	Термостойкие ABS	Tepelně odolná ABS	Топлоустойчив ABS	ABS odporny na ciepło
METAL	Μέταλλο	Металл	Kov	Μетал	Metal
OPAL ACRYLIC	Opal ακρυλικό	Опалового акрила	Opálový akrylát	Opal ακрил	Opal akryl
OPAL GLASS	Opal γυαλί	Матовое стекло	Opálové sklo	Μλечно стъкло	Szkło mleczne
OPAL PMMA	Opal PMMA	PMMA ακριλινικές	Opal PMMA	Opal PMMA	Mlecznego PMMA
OPAL POLYCARBONATE	Opal πολυανθρακικός	Opal πολυκαρβонат	Opal polykarbonát	Opal πολυκαρβонат	Mlecznego Poliwęglan
OPAL POLYETHYLENE	πολυαιθυλένιο opal	πολυαιθυλένιο opal	Polyethylen opál	Πολυαιθυλένιο Opal	Polietylen opal
OPAL PVC	Opal PVC	Opal PVC	Opal PVC	Opal PVC	PVC Poliwęglan
OPTICAL GLASS	Οπτική γυαλί	Οπτική στέγλο	Optické sklo	Οπτική στέγλο	Szklá optycznego
PEMD	PEMD	PEMD	PEMD	PEMD	PEMD
PMMA	PMMA	PMMA	PMMA	PMMA	PMMA
POLYCARBONATE	Πολυκαρβονική	Πολυκαρβонат	Polykarbonát	Πολυκαρβонат	Poliwęglan
PVC	PVC	PVC	PVC	PVC	PVC
RUSTIC GLASS	ρουστίκ Γυαλί	Сельский στέγλο	Rustikální sklo	Рустик стъγλο	Rustic Szkło
STAINLESS STEEL	Ανοξείδωτο χάλυβα	нержавеющая сталь	Nerez	нерждаема стомана	Stal nierdzewnej
STEEL	χάλυβας	στέγλο	Ocel	Стомана	Stal
TEMPERED GLASS	γυαλί	закаленное στέγλο	Tvrzené sklo	Закалено стъγλο	Szkło hartowane
TEMPERED TRANSPARENT GLASS	Μετρίάζεται διαφανές γυαλί	Закаленное прозрачное στέγλο	Tvrzené sklo čiré	Закалено прозрачно стъγλο	Szkło hartowane przezryste
TRANSLUCENT GLASS	Διαφανές γυαλί	Прозрачные στέγλο	Transluent stъγλο	Průhledné sklo	Przezroczyste szkło
TRANSLUCENT POLYCARBONATE	Διαφανές πολυανθρακικός	Прозрачные πολυκαρβонат	Transluent polykarbonát	Průhledné πολυκαρβонат	Przezroczyste Poliwęglan
TRANSLUCENT PVC	Διαφανές PVC	Прозрачные PVC	Transluent PVC	Průhledné PVC	Przezroczyste PVC
TRANSPARENT GLASS	Διαφανές γυαλί	Прозрачное στέγλο	Průhledné sklo	Прозрачно стъγλο	Przezroczystego szkła
TRANSPARENT POLYCARBONATE	διαφανές πολυανθρακικός	прозрачных поликарбонатных	Transparentní polycarbonate	прозрачен поликарβонат	Przezroczysty poliwęglan
TRANSPARENT PVC	Διαφανές PVC	Прозрачное PVC	Průhledné PVC	Прозрачно PVC	PVC Poliwęglan



						
ALUMINIUM ALUMINIO ALUMINIUM ALLUMINIO	BLACK NEGRO NOIR NERO	BLUE AZUL BLEU BLU	BORDEAUX BURDEOS BORDEAUX BORDEAUX	BRASS LATÓN LAITON OTTONE	BROWN MARRÓN MARRON MARRONE	BROWN MARRÓN MARRON MARRONE
						
BRUSHED BROWN MARRÓN CEPILLADO MARRON BROSSE MARRONE SPAZZOLATO	CHROME CROMO CHROMÉ CROMATO	DARK BROWN MARRÓN OSCURO NOYER MARRON MARRONE SCURO	DARK GREY GRIS OSCURO NOYER GRIS GRIGIO SCURO	FUCHSIA FÚCSIA FUCHSIA FUCSIA	GREEN VERDE VERT VERDE	GREY GRIS GRIS GRIGIO
						
GREY GRIS GRIS GRIGIO	COLD WHITE BLANCO FRÍO BLANC FROID BIANCO FREDDO	MATT NICKEL NÍQUEL MATE NICKEL MAT NICKELATO OPACO	NICKEL NÍQUEL NICKEL NICKELATO	ORANGE NARANJA ORANGE ARANCIONE	GREY GRIS GRIS GRIGIO	GOLD ORO OR ORO
						
OLD GOLD ORO ENVEJECIDO OR VIEILLI ORO INVECCHIATO	OLD SILVER PLATA ENVEJECIDO ARGENT VIEILLI ARGENTO INVECCHIATO	POLISHED ALUMINIUM ALUMINIO PULIDO ALUMINIUM POLI ALLUMINIO PULITO	RED ROJO ROUGE ROSSO	RUST ÓXIDO ROUILLE MARRONE OSSIDATO	SILVER PLATA ARGENT ARGENTO	WHITE BLANCO BLANC BIANCO
						
WOOD MADERA BOIS LEGNO						



RECESSED DRAINAGE/DRENAJE EMPOTRABLES/DRAINAGE D'ENCASTRABLES/DRENAGGIO AD INCASSO



Para poder hacer uso de la garantía es imprescindible que la conexión externa sea de un índice de protección (ip) igual o superior a la luminaria adquirida.

In order to validate the warranty the external connection must have always the protection index (ip) with an equal or a superior value of the ip shown on the lamp.

Pour que la garantie soit valable, il est indispensable que la connexion externe soit d'un indice de protection (ip) égal ou supérieur à celui du luminaire acheté.

Per poter usufruire della garanzia è imprescindibile che la connessione esterna sia di un indice di protezione (ip) uguale o superiore a quello indicato sulla lampada acquistata.

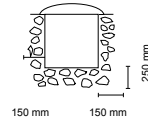
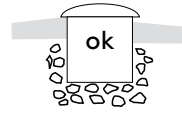

Placing sunken lighting in the ground
Colocación del empotrable en el terreno
Installation de l'encastable sur le terrain
Installazione dell'incasso nel terreno

Minimum drainage measures
Medidas mínimas de drenaje
Mesures de drainage minimum
Misure minime di drenaggio

ENG

Placing sunken lighting in the ground

All sunken lights are ready for installing in the ground or in cement. Always ensure that they are not placed in watercourses or depressions in the ground.

Position the mounting box surrounded by the fastening material to ensure that it does not tip or fall over. There must be a layer of gravel below and around the mounting box for draining purposes (see drawing). Correct drainage should allow 5 litres of water to be absorbed within 8 minutes. The glass can reach high temperatures, so contact with people and objects should be avoided.

We recommend that the outside of the apparatus be cleaned regularly to stop foreign materials from preventing the dissipation of heat which leads to changes in the components and a loss of watertightness.

Follow the installation and assembly instructions and maintenance recommendations very carefully.

Condensation

To minimise possible condensation inside the device, turn it on for 1 hour without the protective glass, closing it immediately once this time has elapsed.

ES

Colocación del empotrable en el terreno

Todos los empotrables están previstos para una instalación en tierra o en cemento. Evite siempre colocarlo en vaguadas o depresiones del terreno.

Coloque la caja de empotrar rodeada de material de sujeción para evitar que se incline o se hunda. Por debajo y alrededor de la caja de empotrar debe existir una capa de grava para drenaje (ver dibujo). Un drenaje correcto debe permitir la absorción de 5 litros de agua en 8 minutos. El cristal puede alcanzar temperaturas elevadas por lo tanto evite el contacto con personas o cosas.

Es aconsejable limpiar frecuentemente el exterior del aparato para evitar así que materiales extraños impidan la disipación del calor con la consiguiente alteración de los componentes y pérdida de estanqueidad.

Siga detenidamente las instrucciones de instalación y montaje así como las recomendaciones de mantenimiento.

Condensación

Para minimizar la posible condensación de vapor de agua dentro del aparato, debe hacerse funcionar durante 1 hora sin el cristal de protección, transcurrido ese periodo de tiempo, ciérrelo inmediatamente.

FR

Installation de l'encastable sur le terrain

Tous les luminaires encastrables sont prévus pour une installation dans la terre ou le ciment. Évitez toujours de les installer dans des lignes de creux ou des dépressions du terrain. Installer le boîtier d'encastrement avec ses supports afin d'éviter qu'il ne soit incliné ni trop enfoncé. Sous le boîtier d'encastrement et autour de celui-ci, il doit y avoir une couche de gravier pour le drainage (voir dessin). Un drainage correct doit permettre l'absorption de 5 litres d'eau en 8 minutes. Le verre peut atteindre des températures élevées, évitez par conséquent tout contact avec les personnes ou des objets. Il est conseillé de nettoyer fréquemment l'extérieur de l'appareil, afin d'éviter que des corps étrangers n'empêchent la dissipation de la chaleur puis l'altération des composants et la perte d'étanchéité. Suivez attentivement les instructions d'installation et de montage, ainsi que les recommandations de maintenance.

Condensation

Pour minimiser les risques de condensation de la vapeur d'eau intérieur de l'appareil doit être exploité pendant une heure sans le verre de protection, après cette période temps, fermer immédiatement.

I

Collocazione dell'incasso nel terreno

Tutti gli incassi sono pensati per la collocazione in terra o cemento. Evitare sempre di installarli in zone umide o depressioni del cemento. Installare sempre l'incasso circondato da materiale d'appoggio, per evitare che si inclini o affondi. Sotto ed intorno all'incasso deve sempre esserci sabbia drenante (disegno).

Un drenaggio efficace deve permettere l'assorbimento di 5 litri d'acqua in 8 minuti. Il vetro può raggiungere temperature elevate, per tanto evitare il contatto con persone o cose.

Si consiglia di pulire frequentemente l'esterno degli apparati per evitare che corpi estranei impidano la dissipazione del calore con conseguente alterazione dei componenti e perdita delle stagnezza. Seguire attentamente le indicazioni di installazione e montaggio, così come le norme di manutenzione.

Condensazione

Per evitare la possibile condensazione di vapore acqueo all'interno dell'apparato, deve porsi in funzione durante una ora senza il cristallo di protezione e poi procedere alla chiusura immediatamente.



BEACONS/BALIZAS/BALISES/LAMPIONI BASSI

To ensure the proper conservations of beacons we recommend their installation on a plinth, never directly onto the ground or lawn.

Para una correcta conservación de las balizas, recomendamos su aplicación sobre una pilastra a un nivel superior, y nunca sobre tierras o césped.

Pour un bon maintenance de balises, nous recommandons son application sur un pilier à un niveau supérieur, et jamais sur terre ou sur l'herbe.

Per una corretta conservazione dei paletti raccomandiamo la sua applicazione su di una base ad un livello più alto, mai su terra o erba.

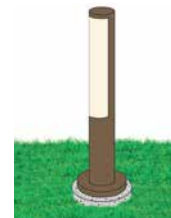

STAINLESS STEEL/ACERO INOXIDABLE/ACCIAIO INOSSIDABILE



ENG

Cleaning and maintenance of stainless steel

It is advisable to follow the recommendations listed below for the correct maintenance and upkeep of all products manufactured from stainless steel

In industrial or coastal areas localized corrosion can be caused by the accumulation of contaminants carried by the air. By using a cloth or duster will insure the elimination of these contaminants. In the case dirt which is more difficult to remove, it is recommended the use of a cleaner which includes phosphoric acid, ensuring that a scrubber or soft nylon brush is used, never use a steel scrubber.

It is recommendable to clean stainless steel every 6 to 12 months for average dirt and every 3 months for more severe cases. Especially in the following atmospheric conditions

- Marine atmospheres.
- Atmospheres which contain a lot of industrial contaminants.
- Atmospheric and traffic pollution.



ES

Limpieza y mantenimiento del acero inoxidable

Le aconsejamos que siga las siguientes recomendaciones para la conservación y mantenimiento de todos aquellos artículos fabricados en acero inoxidable.

En zonas industriales o costeras se pueden producir corrosiones localizadas por acumulaciones de contaminantes llevados por el aire, asegúrese que se eliminan dichos contaminantes utilizando un paño húmedo o una gamuza. En caso de suciedad más difícil le recomendamos que utilice un limpiador que incluya ácido fosfórico siempre con el uso de estropajos o cepillos suaves de nylon, nunca usar estropajos de acero.

La frecuencia de limpieza que le recomendamos para una suciedad moderada es de 6-12 meses y de 3 meses cuando es más abundantes. Especialmente en ambientes que recojan las siguientes condiciones:

- Atmósferas marinas.
- Ambientes cargados de contaminantes industriales.
- Suciedad atmosférica y del tráfico.



FR

Nettoyage et entretien de l'acier inoxydable

Nous vous conseillons de suivre les suggestions pour la conservation et entretien de tous les articles fabriqués en acier inoxydable.

Dans les zones industrielles ou proches au littoral, il peut s'y produire des corrosions localisées par l'accumulation de contaminants apportés par l'air, assurez-vous que ces contaminants puissent s'éliminer avec un torchon humide ou une peau de chamois. En cas de saleté plus difficile, nous vous conseillons d'utiliser un nettoyant à base d'acide phosphorique, toujours à utiliser avec des tampons à récurer ou des brosses douces en nylon, ne jamais utiliser de tampons à récurer en acier. La fréquence de nettoyage que nous vous conseillons pour une saleté modérée est de 6 à 12 mois et de 3 mois quand celle-ci est plus abondante. Surtout dans les ambiances avec les conditions suivantes:

- Atmosphères marines.
- Ambiances chargées de contaminants industriels.
- Saleté atmosphérique et de circulation.



I

Pulizia e manutenzione dell'acciaio inossidabile

Consigliamo di seguire le raccomandazioni per la conservazione e manutenzione di tutti quei prodotti fabbricati in acciaio inossidabile.

In zone industriali o costiere si possono produrre corrosioni localizzate a causa dei contaminanti presenti nell'aria; suddette corrosioni si possono eliminare utilizzando un panno umido o di camoscio. In caso di sporcizia più difficile raccomandiamo l'utilizzo di acido fosforico come prodotto di pulizia e manutenzione (utilizzando spugnette, panni soffici o spazzole di nylon).

La frequenza raccomandata è: 6-12 mesi per una sporcizia moderata, 3 mesi per le più difficili.

Ambienti critici:

- Atmosfera marina
- Ambienti carichi di contaminanti industriali
- Atmosfere cittadine con elevato indice di traffico.



ENG

The first digit (IP x...) indicates the protection from solid objects.

- 0 Non protected.
- 1 Protected against solid objects bigger than 50 mm.
- 2 Protected against solid objects bigger than 12 mm.
- 3 Protected against solid objects bigger than 2,5 mm.
- 4 Protected against solid objects bigger than 1 mm.
- 5 Dust protected.
- 6 Dust tight.

The second digit (IP ...y) indicates protection from moisture.

- 0 Non protected.
- 1 Protected against dripping water.
- 2 Protected against dripping water when tilted up to 15°.
- 3 Protected against spraying water.
- 4 Protected against splashing water.
- 5 Protected against water jets.
- 6 Protected against heavy seas.
- 7 Protected against the effects of immersion.
- 8 Protected against submersion.

ES

La primera cifra (IP x...) indica la protección del aparato contra la penetración de cuerpos sólidos.

- 0 No protegido
- 1 Protegido contra la penetración de cuerpos sólidos con $\varnothing \geq 50$ mm
- 2 Protegido contra la penetración de cuerpos sólidos con $\varnothing \geq 12$ mm
- 3 Protegido contra la penetración de cuerpos sólidos con $\varnothing \geq 2,5$ mm
- 4 Protegido contra la penetración de cuerpos sólidos con $\varnothing \geq 1$ mm
- 5 Protegido contra el polvo
- 6 Totalmente protegido contra el polvo

La segunda cifra (IP ...y) indica la protección del aparato contra la lluvia.

- 0 No protegido
- 1 Protegido contra la caída vertical de gotas de agua
- 2 Protegido contra la lluvia con un ángulo máx de 15° sobre la vertical
- 3 Protegido contra la lluvia con un ángulo máx de 60° sobre la vertical
- 4 Protegido contra salpicaduras y protección del agua
- 5 Protegido contra chorros de agua
- 6 Protegido contra potentes chorros de agua
- 7 Protegido contra inundaciones temporales.
- 8 Protegido contra inmersiones prolongadas

FR

Le premier chiffre (IP x...) indique le degré de protection des parties contre les corps solides.

- 0 Pas de protection.
- 1 Protection contre corps de diamètre supérieur à 50 mm.
- 2 Protection contre corps de diamètre supérieur à 12 mm.
- 3 Protection contre corps de diamètre supérieur à 2,5 mm.
- 4 Protection contre corps de diamètre supérieur à 1 mm.
- 5 Protection contre dépôts de poussière.
- 6 Protection contre toute infiltration de poussière.

Le deuxième chiffre (IP ...y) indique le degré de protection contre l'eau.

- 0 Pas de protection.
- 1 Protection contre chute verticale de gouttes d'eau.
- 2 Protection contre chute de gouttes d'eau jusqu'à 15° de la verticale.
- 3 Protection contre pluie de 0° à 60° de la verticale et ruissellement.
- 4 Protection contre projections d'eau de toutes les directions.
- 5 Protection contre jets d'eau de toutes les directions.
- 6 Protection contre jets d'eau de forte pression et paquets de mer.
- 7 Protection contre immersion à moins d'un metre de profondeur.
- 8 Protection contre immersion permanente à plus d'un metre de profondeur.

PT

O primeiro dígito (IP x...) indica o grau de protecção contra corpos solidos.

- 0 Sem protecção.
- 1 Protegido contra a penetração de corpos solidos com $0 > 50$ mm.
- 2 Protegido contra a penetração de corpos solidos com $0 > 12$ mm.
- 3 Protegido contra a penetração de corpos solidos com $0 > 2,5$ mm.
- 4 Protegido contra a penetração de corpos solidos com $0 > 1$ mm.
- 5 Protegido contra o pó.
- 6 Totalmente protegido contra o pó.

O segundo dígito (IP ...y) indica o grau de protecção contra po e chuva.

- 0 Sem protecção.
- 1 Protegido contra a queda vertical de gotas de água.
- 2 Protegido contra água em forma de chuva com um angulo max. de 15°.
- 3 Protegido contra água em forma de chuva com um angulo max. de 60°.
- 4 Protegido contra projecções de água.
- 5 Protegido contra jactos de água em todas as direcções.
- 6 Protegido contra potentes jactos de água.
- 7 Protegido contra a imersão temporária.
- 8 Protegido contra a imersão prolongada.

**GER**

Die erste Ziffer (IP x...) gibt den Schutz des Apparats gegen das Eindringen von festen Körpern an.

- 0** Nicht geschützt.
1 Geschützt gegen das Eindringen von festen Körpern mit $\varnothing \geq 50$ mm.
2 Geschützt gegen das Eindringen von festen Körpern mit $\varnothing \geq 12$ mm.
3 Geschützt gegen das Eindringen von festen Körpern mit $\varnothing \geq 2,5$ mm.
4 Geschützt gegen das Eindringen von festen Körpern mit $\varnothing \geq 1$ mm.
5 Geschützt gegen Staub.
6 Vollkommen gegen Staub geschützt.

Die zweite Ziffer (IP ...y) gibt den Schutz des Apparats gegen Regen an.

- 0** Nicht geschützt.
1 Geschützt gegen vertikal fallende Wassertropfen.
2 Geschützt gegen Regenfall mit einem Winkel von max. 15° über die alemanSenkrechte.
3 Geschützt gegen Regenfall mit einem Winkel von max. 60° über die Senkrechte.
4 Geschützt gegen Spritzer und Schutz gegen Wasser.
5 Geschützt gegen Wasserschauer.
6 Geschützt gegen starke Wasserschauer.
7 Geschützt gegen zeitweilige Überschwemmungen.
8 Geschützt bei länger anhaltendem Eintauchen.

RUS

Первая цифра (IP x...) указывает на защиту прибора от проникновения твердых тел.

- 0** Не защищен
1 Защищен от проникновения твердых тел $\varnothing \geq 50$ мм
2 Защищен от проникновения твердых тел $\varnothing \geq 12$ мм
3 Защищен от проникновения твердых тел $\varnothing \geq 2,5$ мм
4 Защищен от проникновения твердых тел $\varnothing \geq 1$ мм
5 Защищен от пыли
6 Полностью защищен от пыли

Вторая цифра (IP ...y) указывает на защиту прибора от воды.

- 0** Не защищен
1 Защищен от попадания вертикальных капель воды
2 Защищен от дождевых струй под углом до 15° по вертикали
4 Защищен от брызг и попадания воды
5 Защищен от потоков воды
6 Защищен от сильных потоков воды
7 Защищен от проникновения воды при временном затоплении
8 Защищен от проникновения воды при длительном погружении.

NL

Het eerste cijfer (IP x...) geeft de beschermingsgraad weer van het apparaat tegen het binnendringen van vaste elementen.

- 0** Biedt geen bescherming
1 Biedt bescherming tegen het binnendringen van vaste elementen met $\varnothing \geq 50$ mm.
2 Biedt bescherming tegen het binnendringen van vaste elementen met $\varnothing \geq 12$ mm.
3 Biedt bescherming tegen het binnendringen van vaste elementen met $\varnothing \geq 2,5$ mm.
4 Biedt bescherming tegen het binnendringen van vaste elementen met $\varnothing \geq 1$ mm.
5 Biedt bescherming tegen stof.
6 Biedt volledige bescherming tegen stof.

Het tweede cijfer (IP ...y) geeft de beschermingsgraad van het apparaat tegen de regen weer.

- 0** Biedt geen bescherming
1 Biedt bescherming tegen het verticaal neerkomen van waterdruppels.
2 Biedt bescherming tegen regen met een max. hoek van 15° over verticaal.
3 Biedt bescherming tegen regen met een max. hoek van 60° over verticaal.
4 Biedt bescherming tegen spetters en tegen water.
5 Biedt bescherming tegen waterstralen.
6 Biedt bescherming tegen krachtige waterstralen.
7 Biedt bescherming tegen tijdelijke overstromingen.
8 Biedt bescherming tegen langdurige onderdompelingen.

CZ

První číslice (IP x...) označuje stupeň ochrany přístroje proti průniku pevných částic.

- 0** Nechráněno
1 Chráněno proti průniku pevných částic s $\varnothing \geq 50$ mm
2 Chráněno proti průniku pevných částic s $\varnothing \geq 12$ mm
3 Chráněno proti průniku pevných částic s $\varnothing \geq 2,5$ mm
4 Chráněno proti průniku pevných částic s $\varnothing \geq 1$ mm
5 Chráněno proti prachu
6 Kompletně chráněno proti prachu

Druhá číslice (IP ...y) označuje ochranu proti vnikání vlhkosti.

- 0** Bez ochrany.
1 Ochrana před svisle kapající vodou.
2 Ochrana před vodou kapající se sklonem do 15°.
3 Ochrana před vodou dopadající se sklonem 60° (dešti).
4 Ochrana před stříkající vodou.
5 Ochrana před tryskající vodou (tlakovou vodou).
6 Ochrana před intenzivně tryskající vodou.
7 Ochrana při dočasném ponoření.
8 Ochrana při trvalém ponoření.

I

La prima cifra (IP x...) indica la protezione del sistema contro l'ingresso di corpi solidi.

- 0** Non protetto
1 Protetto contro l'ingresso di corpi solidi con $\varnothing \geq 50$ mm.
2 Protetto contro l'ingresso di corpi solidi con $\varnothing \geq 12$ mm.
3 Protetto contro l'ingresso di corpi solidi con $\varnothing \geq 2,5$ mm.
4 Protetto contro l'ingresso di corpi solidi con $\varnothing \geq 1$ mm.
5 Protetto contro la polvere.
6 Totalmente protetto contro la polvere.

La seconda cifra (IP ...y) indica la protezione del sistema contro la pioggia.

- 0** Non protetto
1 Protetto contro la caduta verticale di gocce d'acqua.
2 Protetto contro la pioggia con angolo max. di 15° sulla verticale.
3 Protetto contro la pioggia con angolo max. di 60° sulla verticale.
4 Protetto contro gli spruzzi e l'ingresso di acqua.
5 Protetto contro i getti d'acqua.
6 Protetto contro i getti potenti d'acqua.
7 Protetto contro inondazioni temporanee.
8 Protetto contro le immersioni prolungate.

BL

Първата цифра (IP x...) означава защита на уреда от попадане на твърди тела.

- 0** Без защита
1 Защита от попадане на твърди тела с $\varnothing \geq 50$ мм
2 Защита от попадане на твърди тела с $\varnothing \geq 12$ мм
3 Защита от попадане на твърди тела с $\varnothing \geq 2,5$ мм
4 Защита от попадане на твърди тела с $\varnothing \geq 1$ мм
5 ащита от прах
6 Изцяло защитен от прах

Втората цифра (IP ...y) указва нивото на защита от влага.

- 0** не е защитен
1 защитен от капеща вода
2 защитен от капеща вода под наклон до 15°
3 защитен от пръски вода
4 защитен от пръскаща вода
5 защитен от водна струя
6 защитен срещу обилни валежи
7 защитен от ефекта на потапяне
8 защитен при потапяне във вода

GRK

Το πρώτο νοούμερο (IP x...) υποδεικνύει την προστασία της συσκευής κατά της διείσδυσης στερεών αντικειμένων.

- 0** Χωρίς προστασία
1 Με προστασία κατά της διείσδυσης στερεών αντικειμένων διαμέτρου $\varnothing \geq 50$ mm
2 Με προστασία κατά της διείσδυσης στερεών αντικειμένων διαμέτρου $\varnothing \geq 12$ mm
3 Με προστασία κατά της διείσδυσης στερεών αντικειμένων διαμέτρου $\varnothing \geq 2,5$ mm
4 Με προστασία κατά της διείσδυσης στερεών αντικειμένων διαμέτρου $\varnothing \geq 1$ mm
5 Με προστασία κατά της σκόνης
6 Με πλήρη προστασία κατά της σκόνης
 Το δεύτερο νοούμερο (IP ...y) υποδεικνύει την προστασία της συσκευής κατά της βροχής.
0 Χωρίς προστασία
1 Με προστασία κατά της κάθετης πτώσης σταγόνων νερού
2 Με προστασία κατά της βροχής με μέγιστη γωνία 15° επί καθέτου
4 Με προστασία κατά των ππισλισμάτων και προστασία νερού
6 Με προστασία κατά της έντονης ροής νερού
7 Με προστασία κατά των παροδικών πλημμυρών
8 Με προστασία κατά της μακρόχρονης βύθισης

PL

Pierwsza cyfra (IP x...) oznacza zabezpieczenie urządzenia przed wnikaniem ciał stałych.

- 0** Niezabezpieczono
1 Zabezpieczono przed wnikaniem ciał stałych za pomocą $\varnothing \geq 50$ mm
2 Zabezpieczono przed wnikaniem ciał stałych za pomocą $\varnothing \geq 12$ mm
3 Zabezpieczono przed wnikaniem ciał stałych za pomocą $\varnothing \geq 2,5$ mm
4 Zabezpieczono przed wnikaniem ciał stałych za pomocą $\varnothing \geq 1$ mm
5 Zabezpieczono przed pyłem
6 Całkowicie zabezpieczono przed pyłem

Druga z cyfr kodu (IP ...y) oznacza stopień ochrony przed wilgocią.

- 0** brak ochrony
1 chronione przed kroplami wody (kapiącymi pionowo)
2 ochrona przed kroplami wody padającymi pod kątem 15° z każdej strony
3 ochrona przed natryskującą wodą
4 ochrona przed rozbrzdującą się wodą
5 ochrona przed strumieniami wody
6 ochrona przed dużymi strumieniami wody
7 ochrona przed zanurzeniem krótkotrwałym w wodzie
8 ochrona przed całkowitym zalaniem wodą (zanurze niem ciągłym)



ES

La información referente a nuestros productos puede ser modificada con el fin de mejorar las características técnicas o de diseño.

Faro Barcelona se reserva el derecho de anular o modificar cualquier modelo sin previo aviso y sin que sea motivo de reclamaciones.

Las condiciones, características y precios de los productos que aparecen en este catálogo son los vigentes en la fecha de impresión del catálogo salvo error tipográfico y están sujetos a posibles modificaciones.

Los precios mostrados son precios de venta al público (PVP).

IVA NO INCLUIDO EN TARIFA

Tarifa no válida para Italia y Suiza.

Previa comunicación a Lorefar sólo se aceptará la mercancía devuelta por defectuosa, nunca por cristales rotos o falta de algún componente. En estos casos rogamos se pongan en contacto con nosotros para enviarles urgentemente las piezas requeridas.

No se admitirán cambios ni devoluciones de mercancía en buen estado. En caso de aceptación explícita por parte de Lorefar, a su recepción y comprobación se emitirá un cargo del 20% en concepto de depreciación y clasificación de la mercancía.

ENG

The technical information detailed in our catalogue can be modified in order to improve the features or design of our products.

Faro Barcelona keeps the right to cancel or modify any model without prior notice and without any cause for complaints.

The conditions, technical characteristics and prices of the products that appear in this catalogue are the effective ones in the date of impression of the catalogue except for typographical error and are subject to possible changes.

The catalogue prices are public prices.

RATES DO NOT INCLUDE VAT.

Price list not valid for Italy and Switzerland.

Returned goods shall only be accepted, after prior notice being given to LOREFAR, on the grounds of being defective and never on the basis of broken glass or missing parts. In such cases, please contact us so that we can send you the required parts as a matter of urgency.

Exchanges or returns of goods in good condition will not be accepted. In the event of express acceptance by LOREFAR, a 20% charge shall be incurred, on receipt and checking, for depreciation and classification of the goods.

FR

L'information qui se réfère à nos produits peut être modifiée afin d'améliorer les caractéristiques technique ou de design.

Faro Barcelona se réserve le droit d'annuler ou de modifier n'importe quel modèle sans préavis et sans que cela soit motif de réclamations.

Les conditions, caractéristiques et prix des produits qui apparaissent dans ce catalogue sont celles en vigueur à la date d'impression du catalogue sauf erreur typographique et sont susceptible d'être modifiées ultérieurement.

Les prix du catalogue son les prix de vente public .

IVA NON COMPRISE DANS LE TARIF.

Liste de prix pas valable pour l'Italie et la Suisse.

Seule sera acceptée en retour la marchandise défectueuse, et ce après communication à LOREFAR. LOREFAR n'acceptera jamais de retour pour du verre brisé ou pour l'absence d'un composant quelconque. Dans ces derniers cas, nous vous prions de vous mettre en contact avec nous afin que nous vous fassions parvenir dans les plus brefs délais les pièces nécessaires. La marchandise en bon état ne sera ni reprise ni échangée. En cas d'acceptation explicite de sa part, LOREFAR retiendra 20% au titre de la dépréciation et de la classification du produit.

PT

A informação referente aos nossos produtos pode ser modificada com o fim de melhorar as características técnicas ou de desenho.

A Faro Barcelona reserva-se o direito de anular ou modificar qualquer modelo sem aviso prévio e sem que seja motivo de reclamações.

As condições, características e preços dos produtos que aparecem neste catálogo são os vigentes na data de impressão do catálogo salvo erro tipográfico e estão sujeitos a possíveis modificações. Os preços mostrados são preços de venda ao público (PVP).

IVA NÃO INCLUÍDO NA LISTA DE PREÇOS

Lista de preços não é válido para a Itália e Suíça.

Mediante comunicação prévia à Lorefar, apenas se aceitará a mercadoria devolvida por defeito, nunca por vidros partidos ou falta de algum componente. Nestes casos pedimos que entrem em contacto conosco para lhes enviarmos urgentemente as peças requeridas.

Não serão admitidas alterações nem devoluções de mercadoria em bom estado. Em caso de aceitação explícita por parte da Lorefar, na sua recepção e comprovação emitir-se-á um débito de 20% a título de depreciação e classificação da mercadoria.

GER

Die Information über unsere Produkte kann im Zusammenhang mit den Verbesserungen ihrer technischen Eigenschaften und ihres Designs jederzeit geändert werden.

Faro Barcelona behält sich das Recht vor, seine Modelle jederzeit und ohne vorherige Ankündigung vom Markt zu nehmen, ohne dass sich daraus ein Anrecht auf Beschwerden ableiten könnte.

Die Bedingungen, Eigenschaften und Preise der Produkte in diesem Katalog gelten zum Datum der Drucklegung des Katalogs vorbehaltlich Druckfehler und können jederzeit geändert werden. Diese Preise gelten für den Direktverkauf an den Kunden.

DIE MEHRWERTSTEUER IST NICHT IN DEN PREISEN EINGESCHLOSSEN

Preisliste gilt nicht für Italien und die Schweiz.

Nach vorheriger Kommunikation kann Lorefar die Rücklieferung von schadhafter Ware akzeptieren, jedoch niemals wegen beschädigten Glasteilen oder fehlenden Komponenten. In letzteren Fällen setzen Sie sich bitte zwecks schneller Zusendung der notwendigen Teile in Verbindung.

Wir tauschen keine Waren in gutem Zustand um oder nehmen sie zurück. Bei ausdrücklicher Annahme durch Lorefar nach Erhalt und Überprüfung stellen wir Ihnen 20% des Preises für Wertverminderung und Handhabung der Ware in Rechnung.

NL

De informatie over onze producten kan gewijzigd worden met als doel de technische eigenschappen of het design te verbeteren.

Faro Barcelona behoudt zich het recht voor onaangekondigd modellen te schrappen of te wijzigen en zonder dat dit aanleiding tot een klacht vormt.

De voorwaarden, eigenschappen en prijzen van de producten in deze catalogus zijn geldig op het moment van druk van de catalogus tenzij sprake is van een drukfout. Zij zijn onderhevig aan mogelijke wijzigingen. De getoonde prijzen betreffen verkoopprijzen.

Btw NIET BIJ DE PRIJS INBEGREPEN

Tarifa niet geldig voor Italië en Zwitserland.

Lorefar aanvaardt uitsluitend defecte teruggezonden goederen nadat zij hierover van tevoren op de hoogte is gesteld. Dit geldt niet voor gebroken glas of het ontbreken van onderdelen. In deze gevallen wordt u verzocht met ons contact op te nemen zodat wij u zo snel mogelijk de gewenste onderdelen kunnen toezenden.

Ruilen of terugsturen van goederen in correcte staat is niet toegestaan. In geval van uitdrukkelijke aanvaarding door Lorefar wordt bij ontvangst en controle een heffing van 20% voor waardevermindering en classificatie van de goederen toegepast.

I

La informazione che si riferisce ai nostri articoli può essere soggetta a modifiche con il fine di migliorare le caratteristiche, tecniche o di design, dei nostri prodotti. Faro Barcelona si riserva il diritto di annullare o modificare qualsiasi modello senza previo avviso e senza che sia motivo di reclami.

Le condizioni, caratteristiche e prezzi dei prodotti che compaiono in questo catalogo sono quelli vigenti alla data della stampa del catalogo ad eccezione di errori tipografici e sono soggetti a possibili modificazioni.

I prezzi indicati sono prezzi di vendita al pubblico.

IVA NON INCLUSA IN LISTINO.

Il listino non è valido per l'Italia e la Svizzera.

LOREFAR accetta previa comunicazione, solo la merce restituita perché difettosa; in nessun caso accetterà la merce restituita per presenza di verti rotti o per mancanza di qualche componente. In questi casi vi preghiamo di contattarci per potervi mandare al più presto i pezzi richiesti.

Non si effettuano cambi né si ammettono restituzioni di merci in buono stato. In caso di accettazione esplicita da parte di LOREFAR, al momento del ricevimento e della verifica della merce si emetterà un addebito del 20% a titolo di deprezzamento e classificazione.

GRK

Οι πληροφορίες σχετικά με τα προϊόντα μας ενδέχεται να τροποποιηθούν με στόχο τη βελτίωση των τεχνικών χαρακτηριστικών ή του σχεδίου.

Η Faro Barcelona διατηρεί το δικαίωμα ακύρωσης ή τροποποίησης οποιουδήποτε μοντέλου χωρίς προηγούμενη προειδοποίηση και χωρίς αυτό να αποτελεί αιτία απαίτησης επιστροφής χρημάτων.

Οι όροι, τα χαρακτηριστικά και οι τιμές των προϊόντων που παρουσιάζονται σε αυτόν τον κατάλογο είναι αυτά που ισχύουν κατά την ημερομηνία της εκτύπωσης του καταλόγου, εκτός τυπογραφικών λαθών, και υπόκεινται σε αλλαγές. Οι τιμές που εμφανίζονται είναι τιμές λιανικής.

Ο ΦΠΑ ΔΕΝ ΣΥΜΠΕΡΙΛΑΜΒΑΝΕΤΑΙ ΣΤΗΝ ΤΙΜΗ

Μετά από συνεννόηση με τη Lorefar, γίνονται αποδεκτές επιστροφές μόνο αν πρόκειται για ελαττωματικά εμπορεύματα και όχι για θραύση κρυστάλλων ή απουσία κάποιου στοιχείου. Στις περιπτώσεις αυτές, παρακαλούμε να έρθετε σε επαφή μαζί μας για να σας στείλουμε επείγοντως τα απαιτούμενα μέρη.

RUS

Информация относящаяся к нашей продукции может быть модифицирована с целью улучшить технические или внешние характеристики.

Faro Barcelona сохраняет за собой право анулировать или модифицировать любую модель без предупреждения и без того что это послужит причиной для жалоб.

Δεν γίνονται αποδεκτές αλλαγές ή επιστροφές για εμπορεύματα σε καλή κατάσταση. Σε περίπτωση ρητής αποδοχής εκ μέρους της Lorefar, κατά την παραλαβή και τον έλεγχο τους θα πραγματοποιηθεί χρέωση 20% για έξοδα απόσβεσης και ταξινόμησης των εμπορευμάτων.

Условия, характеристики и цены на изделия, указанные в данном каталоге, действительны на дату его выпуска, за исключением опечаток в каталоге, и могут быть изменены. В каталоге указаны розничные цены.

БЕЗ УЧЕТА НДС

В соответствии с правилами, компания Lorefar принимает возврат изделий только при наличии дефектов, но ни в коем случае не при разбитии стекла или отсутствии какой-либо детали. В таком случае, пожалуйста, свяжитесь с нами, чтобы мы отправили вам необходимые детали.

Товар в рабочем состоянии не подлежит обмену или возврату. В случае подтверждения компанией Lorefar наличия дефектов, после возврата и проверки, начисляется 20% стоимости с учетом амортизации и классификации товаров.

CZ

Technické informace uvedené v katalogu mohou být modifikovány za účelem zdokonalování vlastností svítidel nebo jejich designu.

Producent Faro Barcelona si vyhrazuje právo konstrukčních změn nabízených modelů bez předcházejícího oznámení a tato skutečnost nemůže být předmětem jakékoliv stížnosti či reklamace.

Podmínky, technické specifikace a ceny produktů uvedené v katalogu jsou platné ke dni vydání katalogu. Producent si vyhrazuje právo konstrukčních změn nabízených modelů, pokud tyto nepovedou k zásadním změnám charakteru výrobků. Informace z tohoto katalogu postrádají platnosti v den vydání katalogu nového.

VŠECHNY CENY JSOU UVEDENY BEZ DPH.

Zboží může být vráceno pouze po předchozím souhlasu od společnosti PAXI, na základě poruchy nebo vady ovšem nikdy na základě poškozeného skla nebo chybnějšího dílu. V takových případech nás, prosím, kontaktujte, abychom Vám mohli požadované části svítidel urgentně zaslat. Výměny nebo vrácení zboží v dobrém technickém stavu je nepřijatelné.

BL

Техническата информация, представена в нашият каталог, може да бъде променяна с цел да подобри представянето или дизайна на продуктите. Фаро Барселона си запазва правото да отменя или променя всеки модел без предварително осведомяване и без това да се счита причина за оплаквания.

Условиата, техническите характеристики и цените на продуктите показани в този каталог са ефективни към датата на отпечатването на каталога, с изключение на грешки при отпечатване и са обект на възможни промени.

Цените в каталога са публичните цени.

ЦЕНИТЕ НЕ ВКЛЮЧВАТ ДДС.

Връщане на закупена стока ще да бъдат приета единствено след писмено осведомяване на ЛОРЕФАР на основание дефекти и в никакъв случай на основание счупено стъкло или липсващи части. В такива случаи моля свържете те с нас, за да ви изпратим липсващите части по спешност. Размяна или връщане на стока в добро състояние няма да бъде извършвана. В случай на спешно приемане от ЛОРЕФАР 20 % такса ще бъде наложена за приемане и проверка, за обезценяване и класификация на продуктите.

PL

Informacje techniczne wyszczególnione w naszym katalogu mogą być modyfikowane w celu poprawienia właściwości lub wzornictwa produktów.

Faro Barcelona ma prawo do anulowania i modyfikowania każdego z modeli bez uprzedzenia infomowania i nie przyjmuje skarg z tego tytułu.

Warunki, opis techniczny oraz ceny artykułów, które pojawiają się w katalogu są aktualne do czasu przedruku katalogu za wyjątkiem pomyłek w druku, które podlegają ewentualnej zmianie. Ceny w katalogu są cenami publicznymi.

CENY NIE ZAWIERAJĄ STAWKI VAT.

Ewentualne zwroty mogą być zaakceptowane po uprzedniej zgodzie przez Lorefar na podstawie stwierdzenia, że są wadliwe, nigdy nie przyjmowane są zwroty artykułów, z powodu stłuczenia szkła czy brakujących części, w tym przypadku prosimy o kontakt w celu wysłania potrzebnych części w trybie natychmiastowym.

Wymiany lub zwroty artykułów w dobrym stanie nie będą zaakceptowane. W przypadku wyraźnej akceptacji przez Lorefar, 20% opłaty może być poniesione na otrzymanie i sprawdzenie, w celu sklasyfikowania uszkodzenia artykułu.



HOME | HOGAR | INTERIEUR

Essential lighting

Amplio abanico de luminarias que ofrecen soluciones funcionales y adaptables a cualquier estilo decorativo (clásico, actual, rústico, elegante) y a cualquier aplicación (iluminación para dormitorios, salones, cocinas, baños y zonas de paso).

Essential lighting

Wide range of light fixtures that offer functional solutions, adaptable to any decorative style (classical, contemporary, rustic, elegant) and any application (lighting for bedrooms, living rooms, kitchens, bathrooms and hallways).

Essential lighting

Une vaste gamme de luminaires qui offrent des solutions fonctionnelles et adaptables à tous les styles de décoration (classique, moderne, rustique, élégante) et à toutes les applications (éclairage pour chambres, salons, cuisines, salles de bain et couloirs).

OUTDOOR | EXTERIOR | EXTERIEUR

Green innovation

Luminarias producidas con materiales y mediante procesos que le confieren una alta resistencia ante condiciones ambientales adversas y que contribuyen con el ahorro energético.

Nuestros modelos abarcan diferentes funcionalidades: apliques, proyectores, balizas, sobremuros, farolas.

Green innovation

Luminaires and fixtures are produced by processes and materials that give them high resistance to adverse environmental conditions and contribute to energy saving.

Our models cover different functionalities: sconces, spotlights, beacons, wallpost lights, lampposts.

Green innovation

Luminaires fabriqués avec des matériaux et des procédés qui leur confèrent une haute résistance aux conditions environnementales adverses et qui contribuent à réaliser des économies d'énergie.

Nos modèles sont très variés: appliques, projecteurs, balises, bornes, lampadaires.

FAN | VENTILACIÓN | VENTILATEUR

Designing the air

Nuestra gama de ventiladores es un referente a nivel europeo no sólo por sus diseños, sino también por la calidad de sus materiales. Modelos diseñados para respetar el silencio y el medio ambiente.

Designing the air

Our range of fans is a European benchmark not only in terms of design, but also the quality of materials. Model designed to respect noise levels and the environment.

Designing the air

Notre gamme de ventilateur est une référence au niveau européen, grâce au design des modèles mais également à la qualité de leurs matériaux.

Nos modèles sont conçus pour respecter le silence et l'environnement.

BULBS | BOMBILLAS | AMPOULES

Better light. Better world

Disponemos de una amplia gama de lámparas que presentan altos niveles de rendimiento y calidad en diferentes formatos: lámparas de bajo consumo, halógenas, led, etc.

Better light. Better world

We have a wide range of high-performance and top-quality lamps in different formats: energy-saving bulbs, halogen, LED, etc.

Better light. Better world

Nous disposons d'une vaste gamme d'ampoules qui offrent des performances et une qualité exceptionnelles dans divers formats: ampoules basse consommation, halogènes, LED, etc.



Ref.	Pag.	Ref.	Pag.	Ref.	Pag.
19026	260	70148	203	70498	259
19027	260	70150	236	70499	259
19028	260	70151	246	70511	159
19029	260	70152	213	70512	159
19030	260	70153	213	70524	249
19031	261	70154	205	70525	241
19032	261	70155	205	70525	249
19034	261	70219	243	70535	249
19035	261	70226	247	70544	225
19036	261	70400	210	70545	225
19037	261	70401	211	70546	163
19038	261	70402	215	70547	163
19039	261	70403	214	70551	157
98101050	265	70404	150	70552	157
300600000F	245	70449	223	70556	158
300600001F	245	70450	207	70560	159
300603000F	245	70451	207	70561	209
300603001F	245	70452	221	70562	209
300603002F	245	70453	221	70564	163
R 7R 143	92	70455	224	70565	153
43070	264	70456	224	70566	149
46060	264	70458N	221	70566N	149
46061	264	70459N	221	70567	149
46067	224	70460	207	70567N	149
63401	187	70462N	221	70568	149
70012	242	70463N	221	70569	149
70021	243	70468	249	70573	169
70023	241	70469	247	70574	185
70120	244	70472	224	70577	143
70122	244	70472	265	70578	143
70131	248	70474	224	70592	223
70137	237	70474	265	70593	223
70138	237	70475	224	70596	226
70139	239	70475	265	70600	217
70140	239	70476	224	70602	217
70141	240	70476	265	70606	215
70142	240	70484	257	70607	215
70143	241	70485	257	70624	167
70144	241	70486	257	70629	85
70146	203	70487	257	70630	85
70147	203	70492	258	70631	85

Ref.	Pag.	Ref.	Pag.	Ref.	Pag.
70632	211	70813	147	71148	188
70633	211	70814	145	71151	39
70634	146	70815	145	71152	39
70635	145	70816	145	71153	39
70636	161	70817	161	71154	39
70655	165	70818	181	71155	39
70656	165	70819	161	71156	39
70689	170	70820	160	71198	125
70690	186	70887	169	71199	125
70694	151	70888	171	71240	198
70696	175	70892	165	71241	198
70697	171	70899	171	71260	194
70700	170	70998	179	71261	194
70702	171	70999	179	71270	194
70713	175	71000	197	71271	194
70714	175	71001	197	71352	73
70715	170	71002	192	71353	153
70717	170	71003	192	71354	217
70719	187	71004	192	71355	217
70720	169	71010B	196	71356	101
70722	187	71011N	196	71357	101
70723	187	71109	106	71358	101
70749	168	71110	106	71359	101
70750	259	71111	109	71362	141
70753	127	71112	109	71363	73
70754	127	71113	107	71365	167
70755	127	71114	107	71366	73
70756	127	71116	111	71367	73
70758	129	71117	111	71368	151
70759	129	71118	110	71369	151
70760	96	71128	106	71375	207
70761	96	71129	106	71382	233
70766	75	71138	108	71383	233
70767	75	71139	108	71384	155
70768	75	71140	105	71385	155
70802	151	71141	105	71389	233
70803	151	71142	105	71390	233
70806	185	71143	104	71391	235
70808	150	71145	103	71393	235
70811	147	71146	103	71420	191
70812	147	71147	181	71424	190



Ref.	Pag.	Ref.	Pag.	Ref.	Pag.
71433	189	72010	195	73131	243
71476	228	72011	195	73150	251
71480	216	72012	195	73196	133
71481	216	72013	195	73254	93
71482	217	72020	197	73255	93
71482	265	72022	197	73256	92
71483	225	72025	199	73260	95
71485	229	72030	197	73261	95
71488	227	72031	197	73315	191
71489	227	72032	197	73398	189
71490	217	72070	195	73431	119
71491	217	72071	195	73432	118
71492	229	72236	177	73434	119
71495	227	72247	177	73436	121
71496	219	72260	175	73438	121
71497	219	72261	174	73440	133
71498	219	72265	173	73450	133
71499	219	72266	173	73456	120
71500	199	72267	153	73460	133
71501	199	72269	150	74101	117
71503	199	72270	167	74102	116
71505	199	72280	177	74104	117
71506	229	72281	176	74121	117
71516	137	72283	154	74122	116
71517	137	72284	155	74132	115
71519	136	72298	126	74134	115
71526	138	72299	131	74252	113
71527	138	72310	131	74254	113
71550	193	72400	79	74257	112
71551	193	72401	79	74258	112
71554	193	72402	81	74261	189
71601	191	72403	81	74349	59
71605	191	73100	250	74350	57
71606	191	73101	250	74351	57
71607	183	73103	251	74353	56
71608	183	73111	250	74355	57
72000	193	73112	251	74356	59
72001	193	73115	265	74357	59
72002	193	73116	265	74358	58
72004	173	73118	251	74359	59

Ref.	Pag.	Ref.	Pag.	Ref.	Pag.
74362	61	74432+74429	49	75099	34
74363	61	74432+74430	44	75100	35
74364	60	74432+74437	40	75101	35
74366	61	74433+74428	53	75102	35
74369	63	74433+74429	49	75103	35
74370	63	74433+74430	45	75105	33
74371	61	74433+74437	41	75106	33
74381	67	74433+74438	41	75108	33
74382	67	74434+74428	53	75110	33
74385	67	74434+74429	49	75500	29
74387	99	74434+74430	45	75501	29
74388	99	74434+74437	41	75502	29
74389	99	74434+74438	41	75503	29
74390	98	74435+74428	55	75504	31
74391	65	74435+74429	51	75505	31
74392	65	74435+74430	46	75506	31
74393	65	74435+74438	43	75507	31
74394	65	74436+74428	55	75509	27
74395	64	74436+74429	51	75510	27
74399	139	74436+74430	47	75511	27
74400	139	74436+74438	43	75512	27
74401	140	74440	23	75513	27
74407	37	74441	24	75514	91
74408	37	74442	23	75515	90
74409	36	74443	25	75516	91
74410	37	74444	25	75518	71
74411	37	74446	21	75519	71
74419	142	74447	21	75520	71
74420	173	74448	21	75521	130
74422	255	74450	69	75522	83
74423	254	74451	69	75523	83
74424	255	74452	69	75524	82
74425	97	74996	87	75525	83
74426	97	74997	89	75526	77
74427+74428	54	74998	87	75527	77
74427+74429	50	74999	89		
74427+74430	47	75000	87		
74427+74437	43	75001	89		
74427+74438	43	75002	87		
74432+74428	53	75003	89		



Mod.	Pag.
aGra	127
aLP [new]	68
aMon [new]	143
aMura	197
áncoRa	140
aPolo	243
aRan	237
arGot	190
aRisto	133
aSkot	197
aTon [new]	236
bAco [new]	161
balDa	259
baLder [new]	247
baStet [new]	213
beRet	82
biRd	26
blINd	146
blUb's	44
boleTus	64
bOnn	171
bOo [new]	258
briNdisi	112
caBo [new]	179
canOn	149
capRi	153
caRtago	92
carTer	215
cEla	177
cEres	183
chAndra [new]	126
ciTrus	209
coAl	167
coBo [new]	150
coDe	138
craTa	149
cripTa	192

Mod.	Pag.
croSby	221
cRoss	56
curTis	221
daDo	191
dakRon	187
dAkyu	187
dAs	70
datNa	22
dElta	170
derBy	193
diDot	151
doRval	175
dragMa	141
driZa	188
eDel	224
eLe [new]	142
ellEn [new]	80
eRio	167
esCa	216
esTay	195
esToril	104
feDon	175
feNes	173
filtEr	207
flAme	173
fuTure	137
gaRda	248
garTen	251
geRa	237
giNa [new]	72
giZa [new]	74
grAnt [new]	165
gRid	170
hePta	198
heRm	167
hOki	245
hoRus [new]	205

Mod.	Pag.
iNari [new]	160
inDi	211
ioN	155
jaiPur	129
jOy	145
kaMal	158
kAmi [new]	154
kaRa	240
keenAn	163
klaMp	36
kOnic	242
kuBick	170
lAce	147
lacRe	151
lanDai	210
latiNa	151
lEd-15	225
lEd-16	225
lEd-18	219
lEd-19	226
lEd-9	249
ledstrip	260
lEva	165
linG	147
liO	227
liSo	217
lONG	90
maDol	241
maRat	157
maRe	145
mAya	177
metRic	207
mini carTer	215
mini raCing	214
mini-conTra	217
mini-gEo	217
miRto	195

Mod.	Pag.
misTu	52
mitRa	102
mOl	169
mOon	40
mUffin	48
mySore	228
naOmi [new]	161
naTron	169
náuTica	106
nAva	244
nAya [new]	125
nEbel	249
neFtis [new]	155
neGus	175
nEo	84
nEwport	38
nisHa [new]	161
noNo	194
noRay [new]	179
nUk	256
onDa	244
onZe	96
oRly	191
óvAlo	197
pAlm	97
pApo	153
pAris	118
paRk	235
parMa	191
piStón	150
poLa	243
pRoa	139
pRoject	232
raciNg	215
radHa [new]	145
rAdio	199
rOndo	196

Mod.	Pag.
rounDer [new]	78
rusTic	181
sAga [new]	76
sAil	100
sAnsón	243
seDna [new]	203
seNa	159
senTinel	34
seTe	130
sEth [new]	247
seTo	189
soBek [new]	246
sOl	98
sOr	173
soRa	131
sPike	251
spOt	199
sTeel	177
sTein	259
sTeps	28
stoRe [new]	207
sUla	211
sUma	168
suRat	131
suRia [new]	223
tAne	150
taRo [new]	223
tarrAco	94
tAsa	185
tAu [new]	20
tecno-1	225
tecNo-3	229
tecNo-6	227
tecNo-7	229
tecno-8	229
tEjo	169
tErra	193

Mod.	Pag.
teRuel	116
tiNia [new]	153
tOledo	114
tOno	251
toRan	239
triAl	66
verNo	133
veRsus	254
vieNa	189
viEw [new]	136
viSnu [new]	181
wAlly	189
wEst	171
wilMa	86
yAk	32
yEn	186
yuCa	187

LOREFAR

**c/Dinámica, 1
08755 Castellbisbal
Barcelona, Spain
faro@lorefar.com
www.faro.es**

Tel. Comercial
902 165 166
Fax. Comercial
937 720 018

Tel. Export
+34 937 723 965
Fax. Export
+34 937 723 967