



INDOOR

Hogar
Intérieur

2016

© LOREFAR, 2016

Referencia/Reference/Référence:

A0267

Primera edició / First edition / Première édition:

Diseño catálogo / Catalogue designer / Conception du catalogue:

Fotografía / Photography / Photographie:

Impresión / Printed by / Imprimer:

Enero / January / Janvier 2016

Faro Barcelona (Joel Polls), Empiezapori Comunicació Gràfica i Web

Guillem FH, Fotodisseny

DILOGRAF

essential
lighting

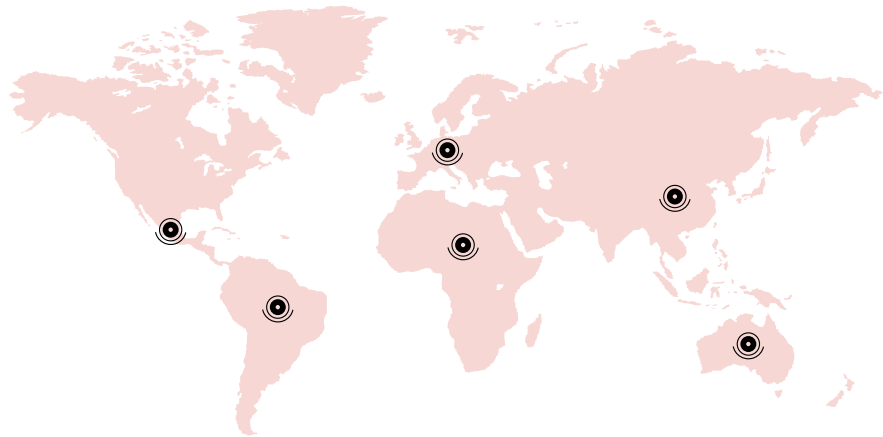


www.faro.es

About us

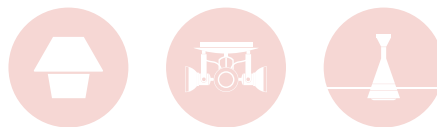
We are a team with international and highly professional profiles covering all phases of the lighting and fan business, from design and manufacturing to distribution.

+90 Countries in which we operate.



+3.000

Lighting & fan solutions.



+60



Years experience.



**Álex &
Manel Llusca**



Conillas



**Estudi
Ribaudí**



**Faro
Team**



**Jordi
Blasi**



**Jordi
Busquets**



**Jordi
Llopis**



**Marina
Milà**



Nahtrang



**Pepe
Llaudet**



Alegre Design



**Xjer
Studio**

*M*ore than 350 registered
products. Ideas born in Barcelona.

Designers



**Series
14**



**Table & floor lamps
102**



**Suspended
124**



**Spotlights
178**



**Track projectors
194**



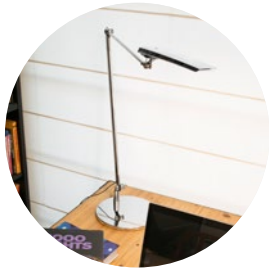
**Wall Fixtures
202**



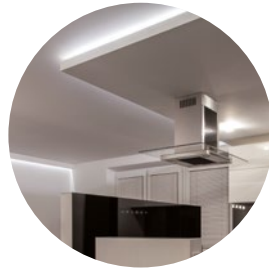
**Ceiling fixtures
274**



**Recessed
316**



**Office
348**



**Special Luminaries
374**

More info

382
Faro
commitment

384
IP information

386
Symbols

388
Materials

390
Finishes

391
General
information



Aina
159



Alma
151



Berni
27



Charlotte
169



Clara
151



Conik
17



Cup
180



Elsa
237



Erma
149



Fusta
35



Greta
361



Handy
205



Iris
293



Ito
355



Juliet
221



Katana
353



Liana
155



Liz
147



Lupe
31



Meier
355



Olaf
237



Pauline
127



Planet
129



Plec
69



Rose
152



Sogo
291



Son
322



Stella
225



Suau
207



Sven
283






Vuk
297



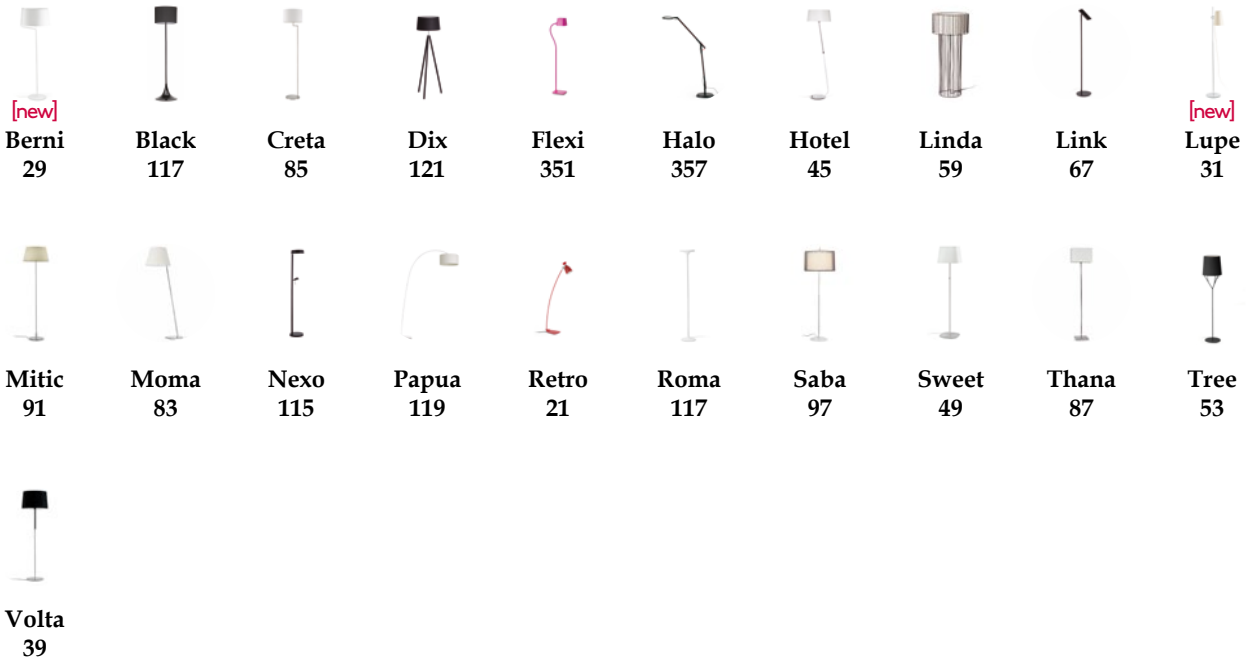
Table Lamps

									
Akane 107	Banker 112	[new] Berni 29	Bliss 111	Chapi 113	Creta 85	Dix 121	Hat 111	Hotel 45	Linda 59
									
Link 67	Lula 105	[new] Lupe 31	Mitic 91	Mix 54	Moma 83	Nidia 113	Retro 21	Saba 97	Sac 75
									
Sweet 49	Thana 87	Tree 52	Versus 109	Vesper 40	Volta 39				

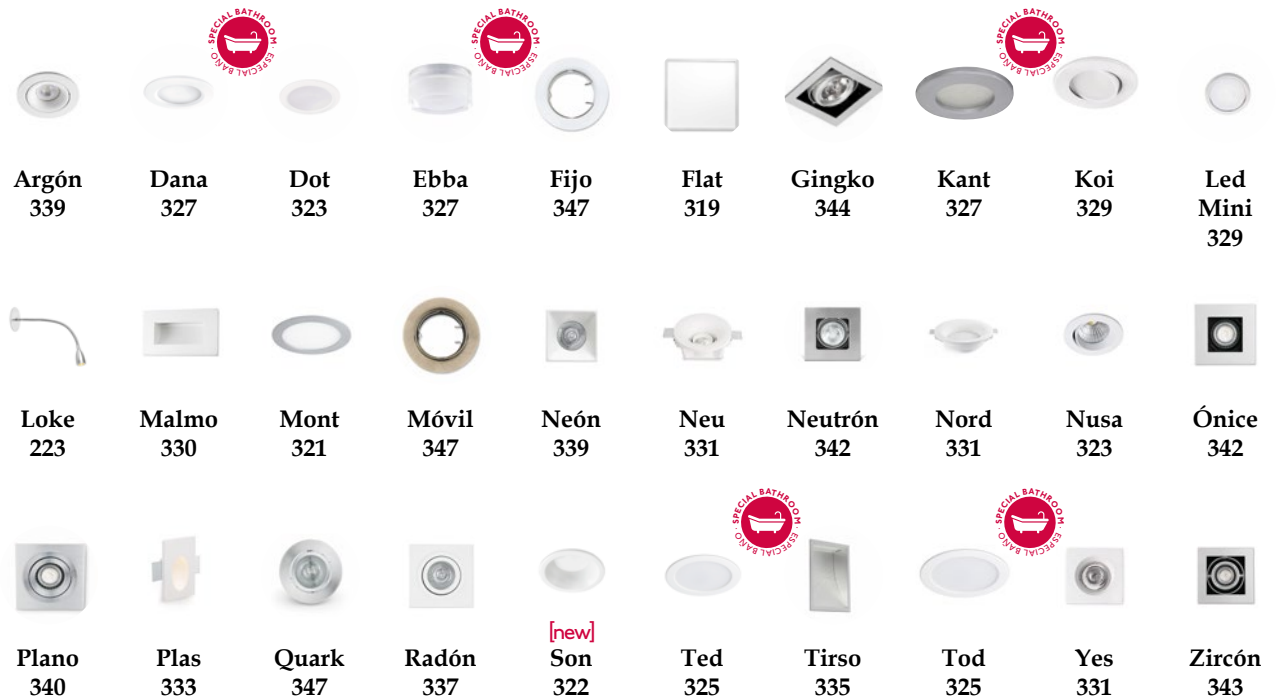
Desk Lamps

									
Anouk 359	Ariel 367	Babá 363	Baobab 365	Bob 371	Elba 367	Flexi 351	[new] Greta 361	Gru 365	Halo 357
									
[new] Ito 355	[new] Katana 353	Láser 372	Lena 361	Lente 372	Leo 366	[new] Meier 355	Mulan 371	Nuka 369	Ona 359
									
Otto 362	Sam 370	Yap 363							

Floor Lamps



Recessed



Wall Lamps + Reader



[new]
Berni
27



[new]
Fusta
35



Hotel
44



[new]
Lupe
33



Mix
55



Moma
81



Room
209



Sabana
211



Sinki
225



[new]
Suau
207



Sweet
48



Vesper
41



Volta
37

Spotlights



Álamo
188



[new]
Cup
181



Galaxia
185



Lune
193



Mika
187



Ring
182



Star
193

Track Projectors



[new]
Cup
197



[new]
Link
199



[new]
Nan
201



Plot
201



Ram
199



Ring
197

Clip



Lea
373



Lena
369



Loke
222



Magni
373



Maket
372



Nuka
368



Ter
369

Wall Lamp Pictures



Degas
255



Henlein
257



Klimt
255



Lumiere
257



Monet
257

Special Luminaires



Ledstrip
376



Unit
378

Pendant Lamps



[new]
Aina
159



Álamo
191



Alder
167



[new]
Alma
151



Aluminio
170



Art
149



Bar
167



Bongo
173



[new]
Charlotte
169



Cilo
171



[new]
Clara
151



[new]
Conik
17



Cráter
165



[new]
Erma
149



[new]
Fusta
35



Halita
145



Hotel
47



Lara
94



[new]
Liana
155



Linda
61



Link
65



Lise
77



[new]
Liz
147



Luce
163



[new]
Lupe
33



Magma
137



Mali
161



Margot
153



Marlin
145



Mia
163



Mitic
93



Mix
56



Murano
160



Nan
141



Nanko
165



Nido
155



Nitro
173



Nudos
101



Óleo
175



Ora
79



Pam
143



Papillon
133



[new]
Pauline
127



Pérgamo
154



[new]
Planet
129



Platillo
171



[new]
Plec
69



Pluma
135



Prosa
159



[new]
Retro
19



[new]
Rose
152



Saba
97



Seven
157



Siria
169



Squad
141



Sweet
51



Tavern
153



Tempo
142



Thana
89



Transfer
175



Tree
53



[new]
Vesper
43







































Volta
38




































































Winch
72

Ceiling Lamps

									
Acacia 307	Adra 304	Ami 298	Azor 311	Cloe 297	Coccote 131	Copic 281	Cora 302	[new] Cup 181	Dante 306
									
Data 306	Dino 307	[new] Foro 298	[new] Iris 293	Janet 289	Kalo 315	Kao 297	Leni 305	Liria 309	Logos 301
									
Mika 187	Nan 281	Pote 285	Rel 282	Retro 23	Ring 183	Ronda 299	[new] Seven 289	[new] Sogo 291	Squad 278
									
[new] Sven 283	Tecto 276	Tola 295	Vera 305	[new] Vuk 297	Yuca 303				

Wall Lamp

									
Álamo 189	Ambo 246	Ángulo 249	[new] Art 233	Aurea 215	[new] Berni 27	Bird 229	Calda 263	Celia 219	Cheras 242
									
Code 231	[new] Conik 17	Cono 245	Creta 84	[new] Cup 180	Dallas 235	Data 250	Diula 252	Doka 267	Eaco 241

 [new] Elsa 237	 Flexi 350	 [new] Fusta 35	 Galaxia 184	 Gina 235	 Groe 239	 [new] Handy 205	 Homs 235	 Hotel 47	 Ibiscus 249
 Ikon 259	 Indo 271	 [new] Juliet 221	 Lampetta 217	 Laos 265	 Lara 95	 [new] Lass 270	 Linda 61	 Link 63	 Liria 248
 Lise 77	 Loke 223	 [new] Lupe 33	 Marlin 233	 Mika 186	 [new] Mild 259	 Mitic 93	 Mix 55	 Moma 81	 [new] Niger 269
 Nudos 101	 Ola 252	 [new] Olaf 237	 Ora 79	 Oslo 239	 Ovo 227	 Petra 219	 [new] Plec 69	 Portos 251	 Ray 220
 Relax 269	 Retro 19	 Ring 183	 Roda 225	 Room 209	 Saba 96	 Sabana 211	 Sac 74	 Sami 221	 Sintra 251
 Siret 261	 Snow 239	 [new] Stella 225	 [new] Suau 207	 Sunny 253	 Sweet 51	 Swing 213	 Terma 263	 [new] Thana 89	 Tub 221
 Twin 245	 Vera 249	 Vesper 41	 Volta 37	 Winch 73					

Berni	26	Sac	74
Conik	16	Sweet	48
Creta	84	Thana	86
Fusta	34	Tree	52
Hotel	44	Vesper	40
Lara	94	Volta	36
Linda	58	Winch	72
Link	62		
Lise	76		
Lupe	30		
Mitic	90		
Mix	54		
Moma	80		
Nudos	100		
Ora	78		
Plec	68		
Retro	18		
Saba	96		



series

Conik [new]

Design: Àlex&Manel
Llusçà



Conik appears when we use new techniques of light, simple lines and the nobility of materials and textures.







[new]

**Pendant
Lamp**

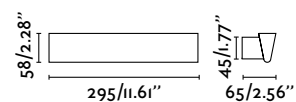
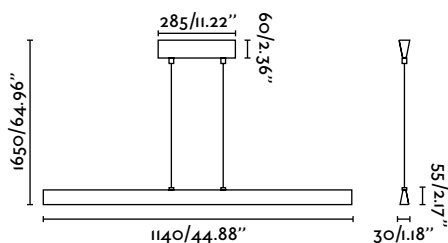
LED

Ref.	64220	 aluminium aluminio
	64221	 white blanco
Bulb	SMD LED 32W 3000K 3200Lm incl.	
Materials	Aluminium + PMMA Aluminio + PMMA	
V/Hz	100-240V / 50-60 Hz	
EEL	A++ to A	
Weight	2.19 kg / 4.83 lb	

+ info

DRIVER 

1.5M





[new]

**Wall
Lamp**

LED

2 POSITIONS
2 POSICIONES

Ref.	64218	 aluminium aluminio
	64219	 white blanco
Bulb	SMD LED 8W 3000K 800Lm incl.	
Materials	Aluminium + PMMA Aluminio + PMMA	
V/Hz	100-240V / 50-60 Hz	
EEL	A++ to A	
Weight	0.5 kg / 1.10 lb	

+ info

DRIVER 

Retro

Design: Àlex&Manel
Llusçà



With
*'60s nostalgia
and looking into the
decoration of the decade,
we created this series of
floodlights, harking back
to shapes and colours of
a retro style.*





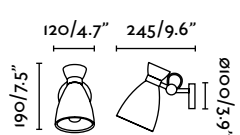
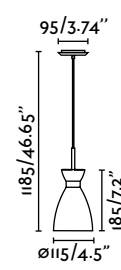
Pendant Lamp

Ref.	Color	Name
20016	beige	beige
20017	olive green	verde oliva
20018	red	rojo
20046	copper	cobre
20050	black+gold	negro+oro

[new]

[new]

Bulb	1xE14 max 20W not incl. [LED 17451]
Materials	Metal
V/Hz	100-240V / 50-60 Hz
EEL	A++ to B
Weight	0.51 kg / 1.12 lb



Wall Lamp

Ref.	Color	Name
20000	beige	beige
20001	olive green	verde oliva
20002	red	rojo
20045	copper	cobre
20049	black+gold	negro+oro

Bulb	1xE14 max 20W not incl. [LED 17451]
Materials	Metal
V/Hz	100-240V / 50-60 Hz
EEL	A++ to B
Weight	0.65 kg / 1.43 lb



[new]

[new]

[new colour]



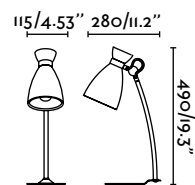



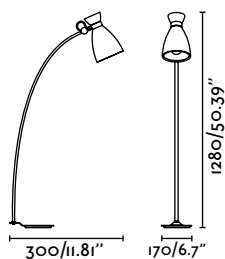





Table Lamp

Ref.	20003		beige beige
	20004		olive green verde oliva
	20005		red rojo
Bulb	1 x E14 max 20W not incl. [LED 17451]		
Materials	Metal Metal		
V/Hz	100-240V / 50-60 Hz		
EEL	A++ to B		
Weight	2 kg / 4.41 lb		

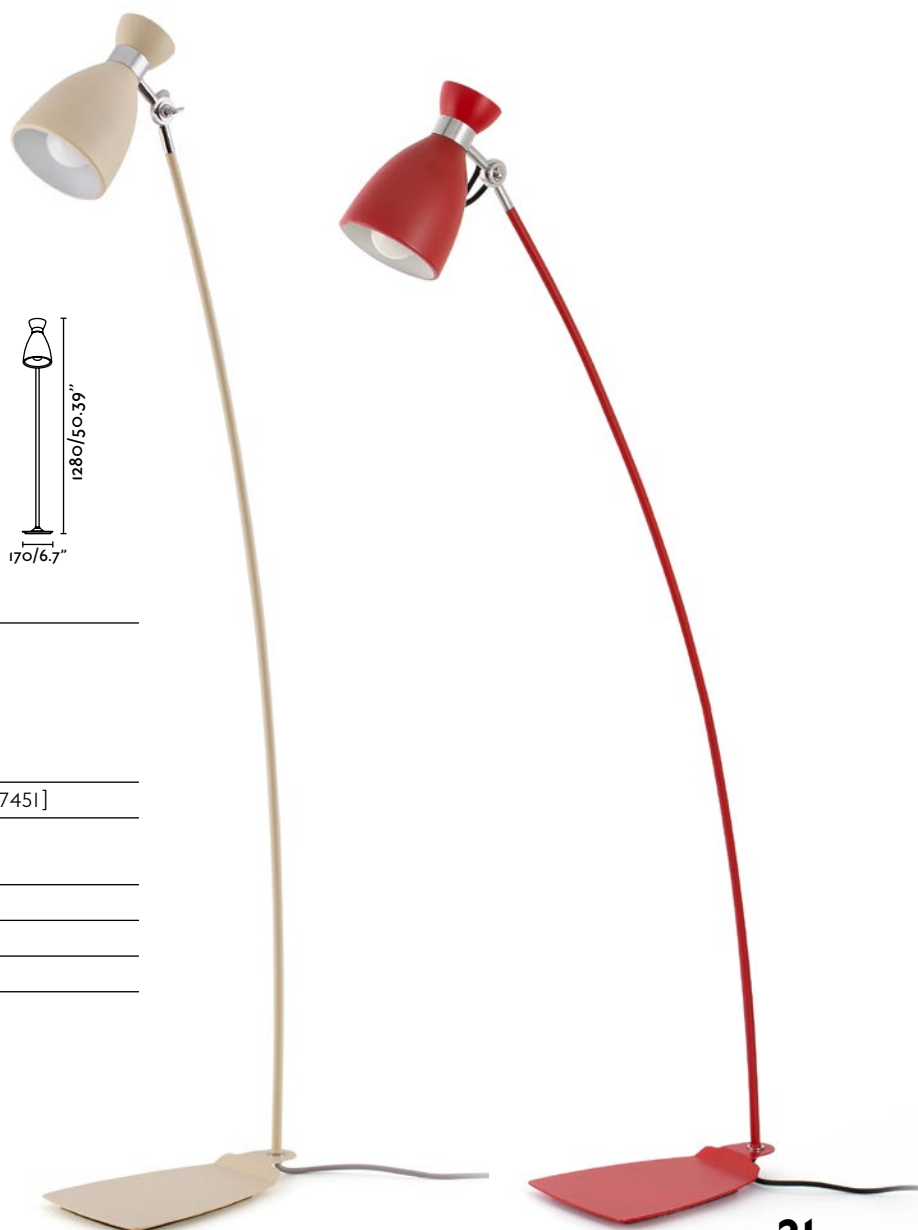
+ info



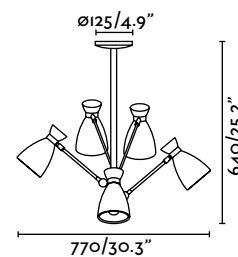
Floor Lamp

Ref.	20009		red rojo
	20019		beige beige
	20020		olive green verde oliva
Bulb	1 x E14 max 20W not incl. [LED 17451]		
Materials	Metal Metal		
V/Hz	100-240V / 50-60 Hz		
EEL	A++ to B		
Weight	2.92 kg / 6.44 lb		




+ info







Ceiling Lamp

Ref.	20010	 beige beige
	20011	 olive green verde oliva
	20012	 red rojo

Bulb 5xE14 max 20W not incl. [LED 17451]

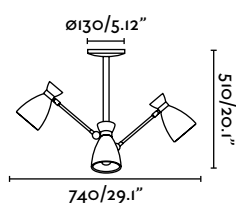
Materials Metal
Metal

V/Hz 100-240V / 50-60 Hz




EEL A++ to B

Weight 2.87 kg / 6.33 lb

+ info



Ceiling Lamp

Ref.	20006	 beige beige
	20007	 olive green verde oliva
	20008	 red rojo

Bulb 3xE14 max 20W not incl. [LED 17451]

Materials Metal
Metal

V/Hz 100-240V / 50-60 Hz

EEL A++ to B

Weight 1.9 kg / 4.19 lb

+ info







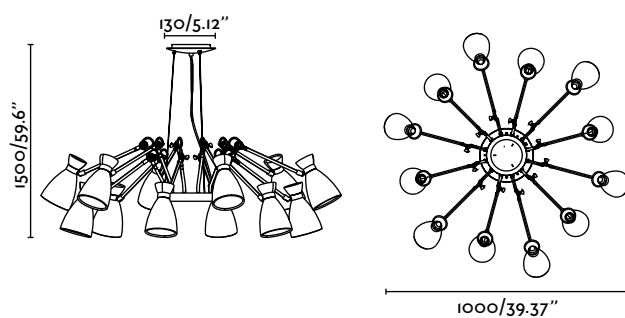


[new]

**Pendant
Lamp**

Ref.	20047		copper cobre
	20048		black+gold negro+oro
Bulb	12xE14 max 20W not incl. [LED 17451]		
Materials	Metal Metal		
V/Hz	100-240V / 50-60 Hz		
EEL	A++ to B		
Weight	8 kg / 17.64 lb		

+ info



Berni [new]

Design: Nahtrang

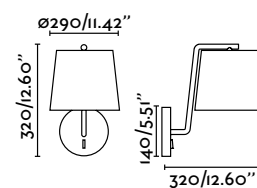


As a rocket capsule suspended in the space, Berni symbolizes a perfect equilibrium. The shade floats on a sinuous structure that shapes out the outline of each piece.





[new]

Wall Lamp

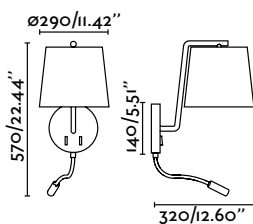
Ref.	29326		white blanco
	29327		black negro
	29328		matt nickel níquel mate

Bulb 1x E27 20W not incl. [LED 17453]**Materials** Metal + Textile
Metal + T xtil**V/Hz** 100-240V / 50-60 Hz**EEL** A++ to B**Weight** 0.8 kg / 1.76 lb

+ info



[new]

Wall Lamp + Reader

Ref.	29329		white blanco
	29330		black negro
	29331		matt nickel níquel mate

Bulb 1x E27 20W not incl. [LED 17453]
+ HIGH POWER LED 3W 3000K 200Lm incl.**Materials** Metal + Textile
Metal + T xtil**V/Hz** 100-240V / 50-60 Hz**EEL** A++ to B**Weight** 0.88 kg / 1.94 lb

+ info





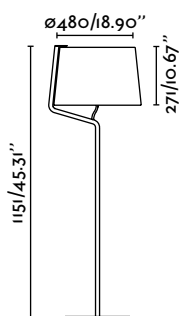


[new]

Floor Lamp



Ref.	29335		white blanco
	29336		black negro
Bulb	1xE27 20W not incl. [LED 17458]		
Materials	Metal + Textile Metal + T��xtil		
V/Hz	100-240V / 50-60 Hz		
EEL	A++ to B		
Weight	6.6 kg / 14.55 lb		

+ info

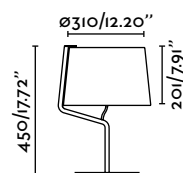


[new]

Table Lamp

Ref.	29332		white blanco
	29333		black negro
Bulb	1xE27 20W not incl. [LED 17453]		
Materials	Metal + Textile Metal + T��xtil		
V/Hz	100-240V / 50-60 Hz		
EEL	A++ to B		
Weight	3.2 kg / 7.05 lb		

+ info

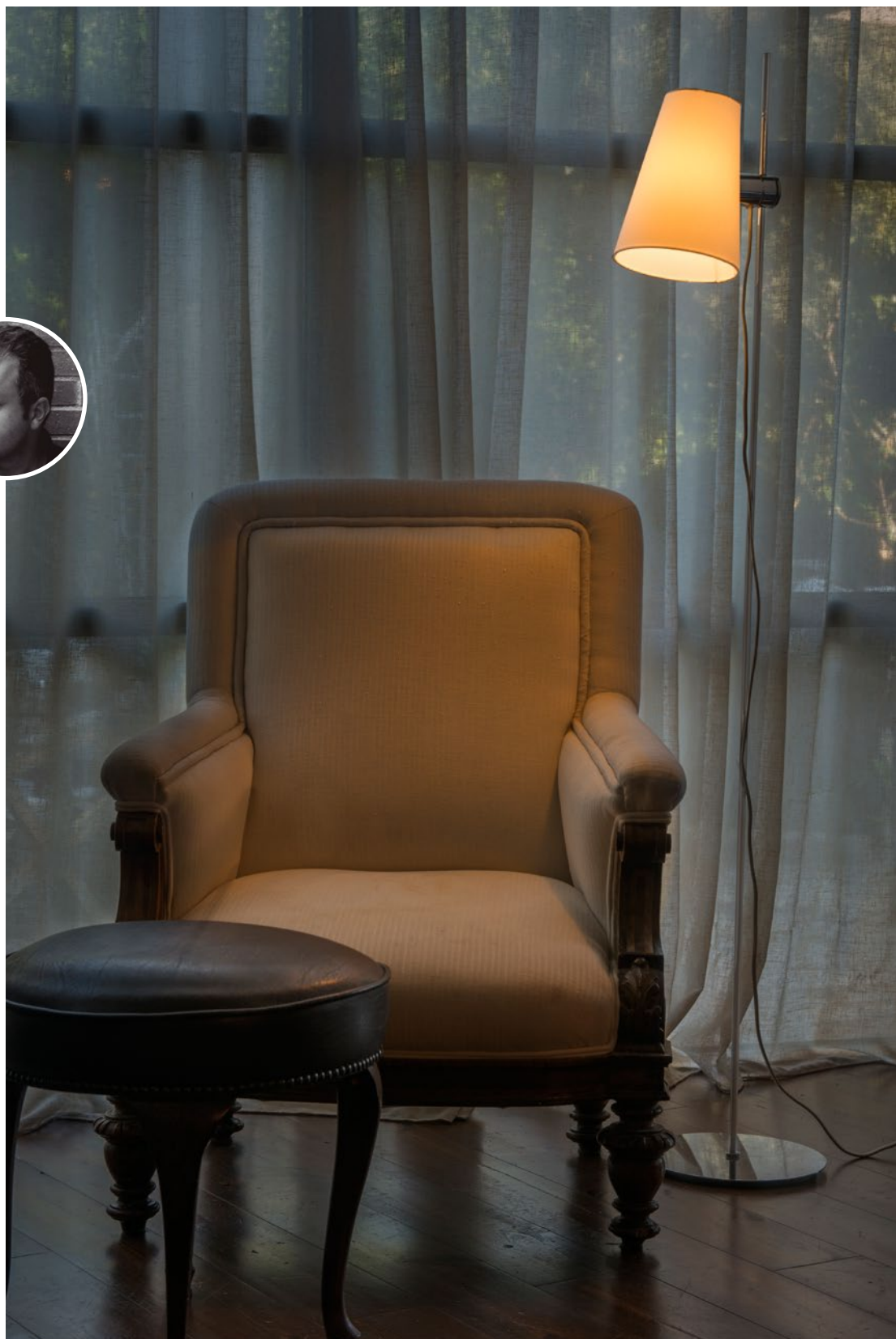


Lupe [new]

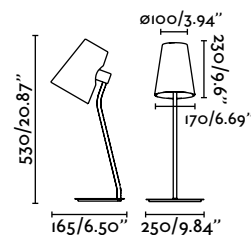
Design: Jordi Busquets



It is a friendly lamp thanks to its innovative system of placing the bulb by its lateral side. Lupe provides a fully illuminated shade, avoiding shadows both above and below.





ADJUSTABLE
AJUSTABLE



[new]

Table Lamp



Ref.	29997	 	chrome+white cromo+blanco
Bulb	1xE27 20W not incl. [LED 17452]		
Materials	Metal + Textile Metal + T�xtil		
V/Hz	220-240V / 50-60 Hz		
EEl	A++ to B		
Weight	1.8 kg / 3.97 lb		

+ info

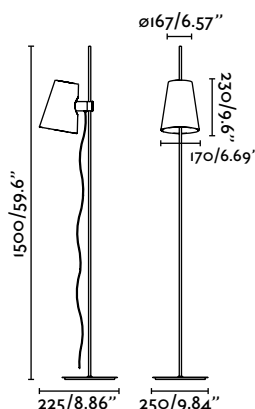


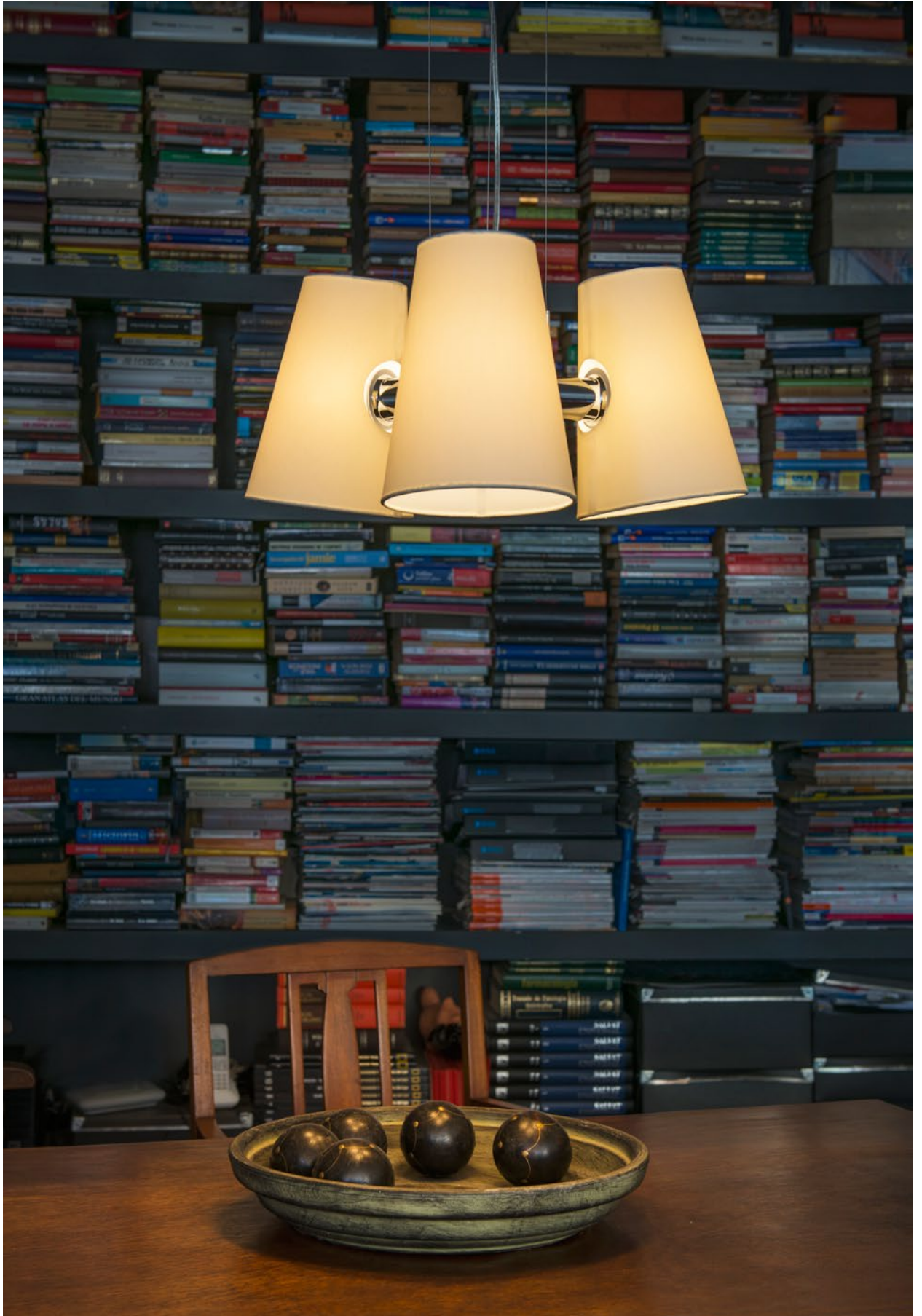
[new]

Floor Lamp

Ref.	29998	 	chrome+white cromo+blanco
Bulb	1xE27 20W not incl. [LED 17453]		
Materials	Metal + Textile Metal + T�xtil		
V/Hz	220-240V / 50-60 Hz		
EEl	A++ to B		
Weight	4.9 kg / 10.80 lb		



+ info



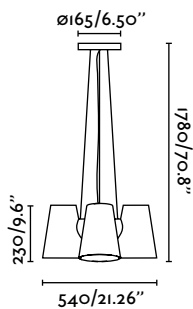


[new]

**Pendant
Lamp**



Ref.	29999	 	chrome+white cromo+blanco
Bulb	3xE27 20W not incl. [LED 17453]		
Materials	Metal + Textile Metal + T�xtil		
V/Hz	220-240V / 50-60 Hz		
EEL	A++ to B		
Weight	1.37 kg / 3.02 lb		

+ info

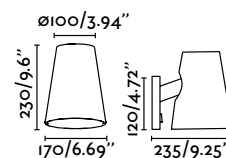


[new]

**Wall
Lamp**



Ref.	29995	 	chrome+white cromo+blanco
Bulb	1xE27 20W not incl. [LED 17452]		
Materials	Metal + Textile Metal + T�xtil		
V/Hz	220-240V / 50-60 Hz		
EEL	A++ to B		
Weight	0.5 kg / 1.10 lb		

+ info

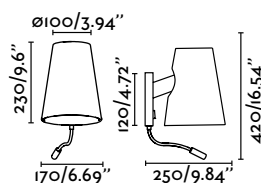


[new]

**Wall
Lamp +
Reader**

Ref.	29996	 	chrome+white cromo+blanco
Bulb	1xE27 20W not incl. [LED 17452] + HIGH POWER LED 1W 3000K 100Lm incl.		
Materials	Metal + Textile Metal + T�xtil		
V/Hz	220-240V / 50-60 Hz		
EEL	A++ to A		
Weight	0.68 kg / 1.50 lb		

+ info



Fusta [new]

Design: Àlex&Manel
Lluscà





An actual
collection that
harmonize the warmth of
wood with the coldness
of the metal.

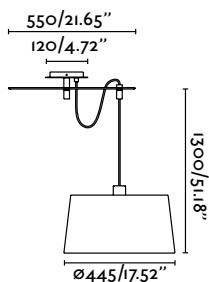


[new]

Pendant
Lamp



Ref.	28394	 	white+wood blanco+madera
Bulb	1xE27 20W not incl. [LED 17458]		
Materials	Metal + Wood + Textile Metal + Madera + T��xtil		
V/Hz	100-240V / 50-60 Hz		
EEL	A++ to B		
Weight	1.54 kg / 3.40 lb		

+ info

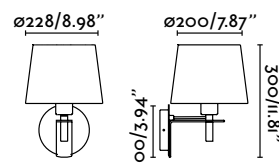


[new]

Wall
Lamp



Ref.	28390	 	white+wood blanco+madera
Bulb	1xE27 20W not incl. [LED 17453]		
Materials	Metal + Wood + Textile Metal + Madera + T��xtil		
V/Hz	100-240V / 50-60 Hz		
EEL	A++ to B		
Weight	0.88 kg / 1.94 lb		

+ info

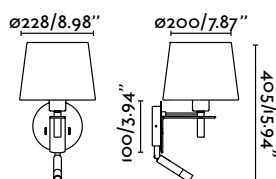


[new]

Wall
Lamp +
Reader

Ref.	28391	 	white+wood blanco+madera
Bulb	1xE27 20W not incl. [LED 17453] + HIGH POWER LED 3W 3000K 140Lm incl.		
Materials	Metal + Wood + Textile Metal + Madera + T��xtil		
V/Hz	100-240V / 50-60 Hz		
EEL	A++ to B		
Weight	0.92 kg / 2.03 lb		

+ info





Volta

Design: Estudi Ribaudí

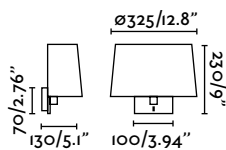
Volta is a timeless family with an elegant design. It proposes Nordic design spaces in perfect harmony.





**Wall
Lamp**

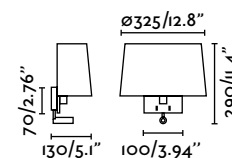
Ref.	20021		matt nickel+white níquel mate+blanco
	20022		matt nickel+black níquel mate+negro
Bulb	1xE27 max 20W not incl. [LED 17453]		
Materials	Metal + Textile Metal + T��xtil		
V/Hz	100-240V / 50-60 Hz		
EEl	A++ to B		
Weight	0.52 kg / 1.15 lb		

+ info


**Wall
Lamp +
Reader**





Ref.	20023		matt nickel+white níquel mate+blanco
	20024		matt nickel+black níquel mate+negro
Bulb	1xE27 max 20W not incl. [LED 17453] + HIGH POWER LED 3W 3000K 200LM incl.		
Materials	Metal + Textile Metal + T��xtil		
V/Hz	100-240V / 50-60 Hz		
EEl	A++ to B		
Weight	0.72 kg / 1.59 lb		

+ info

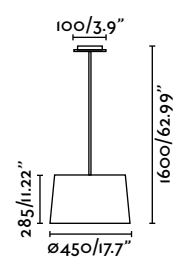




**Pendant
Lamp**

Ref.	20027			matt nickel+white níquel mate+blanco
	20028			matt nickel+black níquel mate+negro
Bulb	1xE27 max 20W not incl. [LED 17458]			
Materials	Metal + Textile Metal + Tèxtil			
V/Hz	100-240V / 50-60 Hz			
EEL	A++ to B			
Weight	0.96 kg / 2.12 lb			

+ info    I.3M



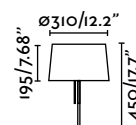






Table Lamp

Ref.	20025			matt nickel+white níquel mate+blanco
	20026			matt nickel+black níquel mate+negro

Bulb 1xE27 max 20W not incl. [LED 17453]

Materials Metal + Textile
Metal + T xtil

V/Hz 100-240V / 50-60 Hz





EEL A++ to B

Weight 1.05 kg / 2.31 lb

+ info



Floor Lamp

Ref.	20029			matt nickel+white níquel mate+blanco
	20030			matt nickel+black níquel mate+negro

Bulb 1xE27 max 20W not incl. [LED 17458]

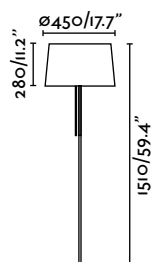
Materials Metal + Textile
Metal + T xtil

V/Hz 100-240V / 50-60 Hz

EEL A++ to B

Weight 2.85 kg / 6.28 lb

+ info



Vesper





Design: Nahtrang

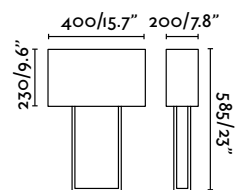


Vesper is a tribute to Remmi Mackintosh, one of the architects who broke the mould schemes looking for pure and rational forms.



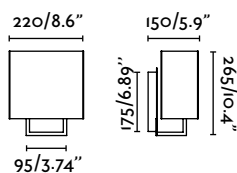
Table Lamp

Ref.	29984	 	white+beige blanco+beige
	29985	 	dark brown+beige marrón oscuro+beige
Bulb	2xE27 max 20W not incl. [LED 17453]		
Materials	Metal + Textile Metal + T�xtil		
V/Hz	100-240V / 50-60 Hz		
EEL	A++ to B		
Weight	3.15 kg / 6.94 lb		







+ info





Wall Lamp

Ref.	29980			white+beige blanco+beige
	29981			dark brown+beige marrón oscuro+beige

Bulb 1xE14 max 20W not incl. [LED 17451]

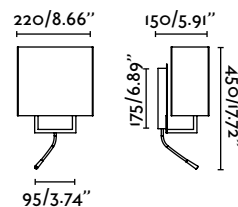
Materials Metal + Textile
Metal + T xtil

V/Hz 100-240V / 50-60 Hz




EEL A++ to B

Weight 1.4 kg / 3.09 lb

+ info



Wall Lamp + Reader

Ref.	29982			white+beige blanco+beige
	29983			dark brown+beige marr�n oscuro+beige

Bulb 1xE14 max 20W not incl. [LED 17451]
+ HIGH POWER LED 1W 3000K 120 Lm incl.

Materials Metal + Textile
Metal + T xtil

V/Hz 100-240V / 50-60 Hz

EEL A++ to C

Weight 1.55 kg / 3.42 lb

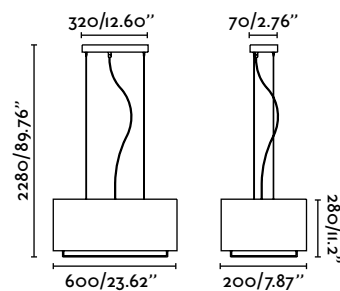
+ info











[new]

**Pendant
Lamp
60cm**


Ref.	29986			white+ white blanco+ blanco
	29987			dark brown+white marrón oscuro+blanco

Bulb 2xE27 max 20W not incl. [LED 17453]

Materials Metal + Textile
Metal + T xtil

V/Hz 100-240V / 50-60 Hz

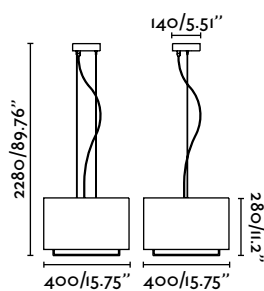
EEL A++ to B





Weight 3.58 kg / 7.89 lb

+ info



[new]

**Pendant
Lamp
40cm**


Ref.	29988			white+ white blanco+ blanco
	29989			dark brown+white marr�n oscuro+blanco

Bulb 3xE27 20W not incl. [LED 17453]

Materials Metal + Textile
Metal + T xtil

V/Hz 100-240V / 50-60 Hz

EEL A++ to B

Weight 4.1 kg / 9.04 lb

+ info



Hotel

Design: Àlex&Manel
Llusçà



The Hotel serie aims to achieve a simple and somewhat neutral line, giving prominence to the warmth and comfort it offers. For a relaxing and pleasant environment.



Wall Lamp + Reader

Ref. **29941**   chrome+white
cromo+blanco

29946   chrome+black
cromo+negro

Bulb 1xE27 max 15W not incl. [LED 17453]
HIGH POWER LED 1W 3500K incl.

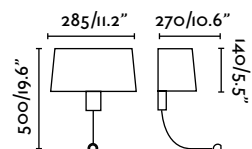
Materials Metal + Textile
Metal + Tèxtil

V/Hz 100-240V / 50-60 Hz

EEL A++ to A









Weight 1.5 kg / 3.31 lb

+ info





Floor Lamp

Ref.	29943			chrome+white cromo+blanco
	29948			chrome+black cromo+negro
Bulb	1xE27 max 20W not incl. [LED 17458]			
Materials	Metal + Textile Metal + T�xtil			
V/Hz	100-240V / 50-60 Hz			
EEL	A++ to B			
Weight	7.1 kg / 15.65 lb			
+ info				

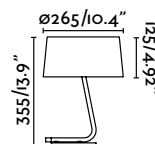








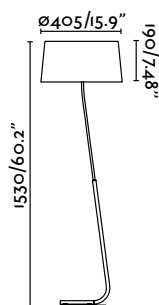
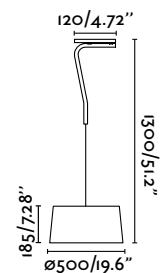


Table Lamp





Ref.	29942			chrome+white cromo+blanco
	29947			chrome+black cromo+negro
Bulb	1xE27 max 20W not incl. [LED 17453]			
Materials	Metal + Textile Metal + T�xtil			
V/Hz	100-240V / 50-60 Hz			
EEL	A++ to B			
Weight	2.8 kg / 6.17 lb			
+ info				



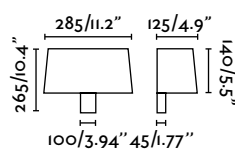








Pendant Lamp

Ref.	29944			chrome+white cromo+blanco
	29949			chrome+black cromo+negro
Bulb	3xE27 max 20W not incl. [LED 17458]			
Materials	Metal + Textile Metal + T�xtil			
V/Hz	100-240V / 50-60 Hz			
EEl	A++ to B			
Weight	5 kg / 11.02 lb			

+ info



Wall Lamp

Ref.	29940			chrome+white cromo+blanco
	29945			black+chrome negro+cromo
Bulb	1xE27 max 15W not incl. [LED 17453]			
Materials	Metal + Textile Metal + T�xtil			
V/Hz	100-240V / 50-60 Hz			
EEl	A++ to B			
Weight	1.1 kg / 2.43 lb			

+ info







Sweet

Design: Estudi Ribaudf

Sweet is characterised by its rounded shapes and the harmony of its changes in texture that interact with us in a perfect balance.



Wall Lamp + Reader

Ref.	29935	 	matt nickel+white níquel mate+blanco
	29950		white blanco
	29951		black negro

Bulb 1xE27 max 15W not incl. [LED 17453]
HIGH POWER LED 1W incl.

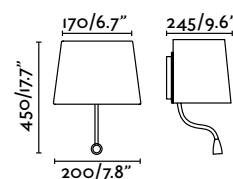
Materials Metal + Textile
Metal + T xtil

V/Hz 100-240V / 50-60 Hz

EEL A++ to B







Weight 1.7 kg / 3.75 lb

+ info





Floor Lamp

Ref.	29938			matt nickel+white níquel mate+blanco
	29958			white blanco
	29959			black negro

Bulb 1xE27 max 20W not incl. [LED 17458]

Materials Metal + Textile
Metal + T xtil

V/Hz 100-240V / 50-60 Hz

EEL A++ to B

Weight 5.8 kg / 12.79 lb

+ info

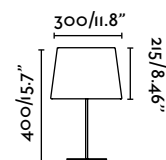








Table Lamp

Ref.	29937			matt nickel+white níquel mate+blanco
	29954			white blanco
	29955			black negro

Bulb 1xE27 max 20W not incl. [LED 17453]

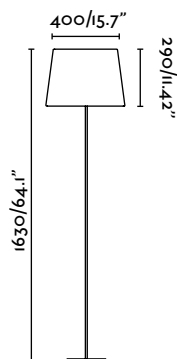
Materials Metal + Textile
Metal + T xtil

V/Hz 100-240V / 50-60 Hz

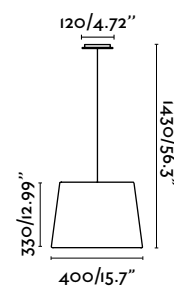
EEL A++ to B

Weight 3.6 kg / 7.94 lb





+ info







Pendant Lamp

Ref.	29939			matt nickel+white níquel mate+blanco
	29956			white blanco
	29957			black negro

Bulb 1xE27 max 20W not incl. [LED 17458]

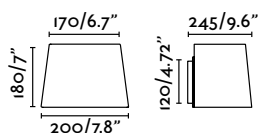
Materials Metal + Textile
Metal + T  xtil

V/Hz 100-240V / 50-60 Hz





EEL A++ to B

Weight 2.9 kg / 6.39 lb

+ info



Wall Lamp

Ref.	29936			matt nickel+white níquel mate+blanco
	29952			white blanco
	29953			black negro

Bulb 1xE27 max 15W not incl. [LED 17453]

Materials Metal + Textile
Metal + T  xtil

V/Hz 100-240V / 50-60 Hz

EEL A++ to B

Weight 1.2 kg / 2.65 lb

+ info








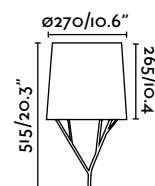
Tree

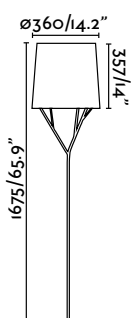
Design: Estudi Ribaudf

Tree stems from the interaction of human beings with their environment. Its branches grow towards the top, which is where the light emerges from.





Table Lamp	
Ref.	29866  black negro 29867  white blanco
Bulb	1xE27 max 60W not incl. [LED I7458]
Materials	Metal + Textile Metal + T�xtil
V/Hz	100-240V / 50-60 Hz
EEL	A++ to E
Weight	3.9 kg / 8.60 lb
+ info	  

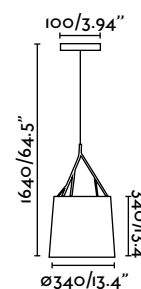






Floor Lamp

Ref.	29868		black negro
	29869		white blanco
Bulb	1 x E27 max 60W not incl. [LED 17458]		
Materials	Metal + Textile Metal + T�xtil		
V/Hz	100-240V / 50-60 Hz		
EEL	A++ to E		
Weight	8.2 kg / 18.08 lb		

+ info



Pendant Lamp

Ref.	29864		black negro
	29865		white blanco
Bulb	1 x E27 max 100W not incl. [LED 17458]		
Materials	Metal + Textile Metal + T�xtil		
V/Hz	100-240V / 50-60 Hz		
EEL	A++ to E		
Weight	3 kg / 6.61 lb		

+ info





Mix

Design: Àlex&Manel
Lluscà

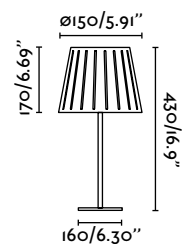
A mixture of materials for a series that provides the warmth of light by creating a comfortable environment. Discrete slits allow light to shine out, generating a chiaroscuro effect.

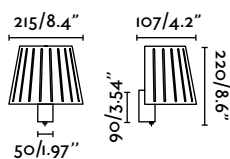




Table Lamp

Ref.	29970  white blanco
	29971  black negro
Bulb	1 x E14 max 60W not incl. [LED 17451]
Materials	Metal + Wood Metal + Madera
V/Hz	100-240V / 50-60 Hz
EEL	A++ to E
Weight	2.3 kg / 5.07 lb

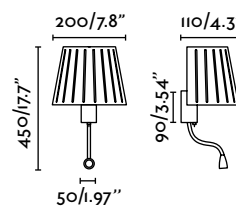
+ info






**Wall
Lamp**

Ref.	29964		white blanco
	29965		black negro
Bulb	1xE27 max 60W not incl. [LED 17452]		
Materials	Metal Metal		
V/Hz	100-240V / 50-60 Hz		
EEl	A++ to E		
Weight	0.8 kg / 1.76 lb		

+ info


**Wall
Lamp +
Reader**



Ref.	29962		white blanco
	29963		black negro
Bulb	1xE27 max 60W not incl. [LED 17452] HIGH POWER LED 3W incl.		
Materials	Metal Metal		
V/Hz	100-240V / 50-60 Hz		
EEl	A++ to D		
Weight	1.2 kg / 2.65 lb		

+ info

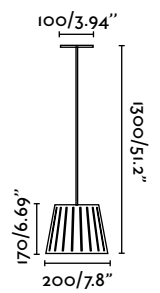


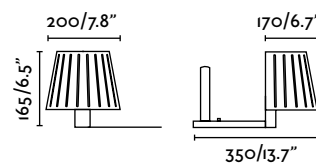
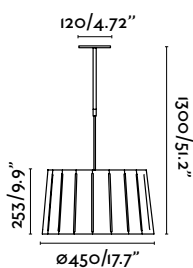


Pendant Lamp



Ref.	29966  white blanco
	29967  black negro
Bulb	1xE14 max 60W not incl. [LED 17451]
Materials	Metal Metal
V/Hz	100-240V / 50-60 Hz
EEL	A++ to E
Weight	1.2 kg / 2.65 lb

+ info  







Pendant Lamp

Ref.	29968		white blanco
	29969		black negro
Bulb	2xE27 max 60W not incl. [LED 17458]		
Materials	Metal + Wood Metal + Madera		
V/Hz	100-240V / 50-60 Hz		
EEl	A++ to E		
Weight	4.9 kg / 10.80 lb		

+ info



Shelf Wall Lamp

Ref.	29960		white blanco
	29961		black negro
Bulb	1xE14 max 14W not incl. [LED 17451]		
Materials	Metal Metal		
V/Hz	100-240V / 50-60 Hz		
EEl	A++ to E		
Weight	1.4 kg / 3.09 lb		

+ info



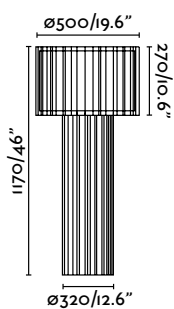
Linda

Design: Estudi Ribaudí





Linda projects light through its structure, creating a pattern of light and shadow that confers movement and energy to our spaces.





Floor Lamp

Ref.	29308		white blanco
	29312		black negro
Bulb	1xE27 max 100W not incl. [LED 17458]		
Materials	Steel + Textile Acero + T�xtil		
V/Hz	100-240V / 50-60 Hz		
EEL	A++ to E		
Weight	6.5 kg / 14.33 lb		

+ info

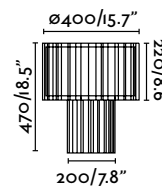




Table Lamp



Ref.	29307		white blanco
	29311		black negro
Bulb	1xE27 max 100W not incl. [LED 17458]		
Materials	Steel + Textile Acero + T�xtil		
V/Hz	100-240V / 50-60 Hz		
EEL	A++ to E		
Weight	3.5 kg / 7.72 lb		

+ info

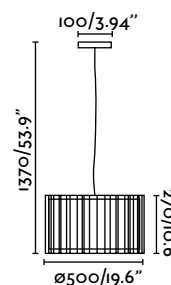






Wall Lamp

Ref.	29306		white blanco
	29310		black negro
Bulb	2xE27 max 15W not incl. [LED 17452]		
Materials	Steel + Textile Acero + T�xtil		
V/Hz	100-240V / 50-60 Hz		
EEL	A++ to A		
Weight	1.4 kg / 3.09 lb		

+ info 



Pendant Lamp

Ref.	29309		white blanco
	29313		black negro
Bulb	1xE27 max 100W not incl. [LED 17458]		
Materials	Steel + Textile Acero + T�xtil		
V/Hz	100-240V / 50-60 Hz		
EEL	A++ to E		
Weight	4.8 kg / 10.58 lb		

+ info  

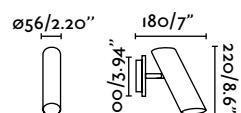
Link

Design: Estudi Ribaudf



Link is the synthesis of a spot as an object. It is a search for the absence of shape, a simple gesture to give sense to its aesthetic.





Wall Lamp

Ref.	29873		white blanco
	29874		black negro

Bulb 1xGU10 max II W not incl. [LED 17316]

Materials Steel
Acero

V/Hz 100-240V / 50-60 Hz

EEL A++ to B

Weight 0.6 kg / 1.32 lb

+ info



Wall Lamp

Ref.	29875		white blanco
	29876		black negro

Bulb 2xGU10 max II W not incl. [LED 17316]

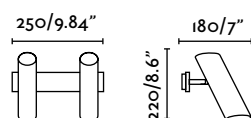
Materials Steel
Acero

V/Hz 100-240V / 50-60 Hz

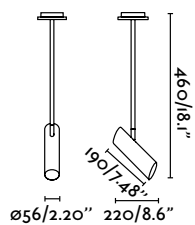
EEL A++ to B

Weight 1.2 kg / 2.65 lb



+ info



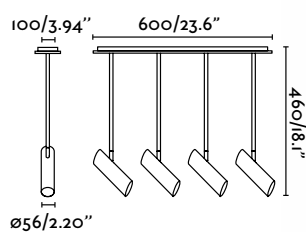






Pendant Lamp

Ref.	29877		white blanco
	29878		black negro
Bulb	1xGU10 max II W not incl. [LED 17316]		
Materials	Steel Acero		
V/Hz	100-240V / 50-60 Hz		
EEl	A++ to B		
Weight	0.8 kg / 1.76 lb		

+ info



Pendant Lamp

Ref.	29879		white blanco
	29880		black negro
Bulb	4xGU10 max II W not incl. [LED 17316]		
Materials	Steel Acero		
V/Hz	100-240V / 50-60 Hz		
EEl	A++ to B		
Weight	3.3 kg / 7.28 lb		



+ info







Floor Lamp

Ref.	29883		white blanco
	29884		black negro
Bulb	1xGU10 max IIW not incl. [LED 17316]		
Materials	Steel Acero		
V/Hz	100-240V / 50-60 Hz		
EEL	A++ to B		
Weight	3.1 kg / 6.83 lb		

+ info

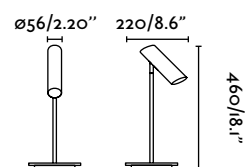


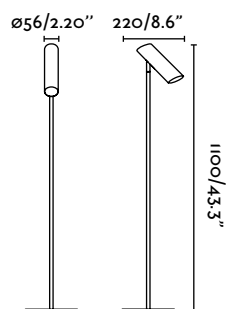


Table Lamp

Ref.	29881		white blanco
	29882		black negro
Bulb	1xGU10 max IIW not incl. [LED 17316]		
Materials	Steel Acero		
V/Hz	100-240V / 50-60 Hz		
EEL	A++ to B		
Weight	1.77 kg / 3.90 lb		

+ info



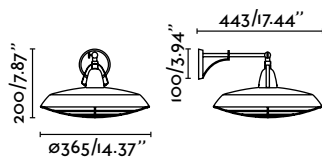
Plec [new]

Design: Àlex&Manel
Llusçà



To create the collection PLEC we have been inspired by the old but near post-industrial trends.





[new]

Wall Lamp IP44 LED

Ref. **66208** rust brown
marrón óxido

66209 off white
blanco roto

Bulb SMD LED 15W 2700K 1200Lm incl.

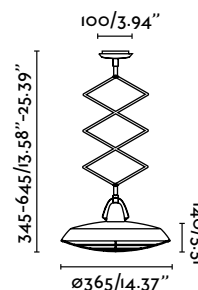
Materials Steel + PVC
Acero + PVC

V/Hz 220-240V / 50-60 Hz

EEL A++ to A

Weight 1.83 kg / 4.03 lb

+ info IP44 DRIVER



[new]

Pendant Lamp LED EXTENSIBLE IP44

Ref. **66212** rust brown
marrón óxido

66213 off white
blanco roto

Bulb SMD LED 15W 2700K 1200Lm incl.

Materials Steel + PVC
Acero + PVC

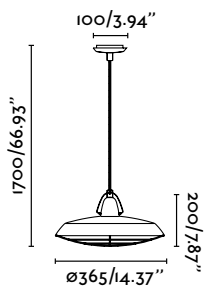
V/Hz 220-240V / 50-60 Hz

EEL A++ to A

Weight 2.52 kg / 5.56 lb

+ info IP44 DRIVER






[new]

Pendant Lamp

LED IP44

Ref.	66210		rust brown marrón óxido
	66211		off white blanco roto
Bulb	SMD LED 15W 2700K 1200Lm incl.		
Materials	Steel + PVC Acero + PVC		
V/Hz	220-240V / 50-60 Hz		
EEL	A++ to A		
Weight	1.8 kg / 3.97 lb		



+ info



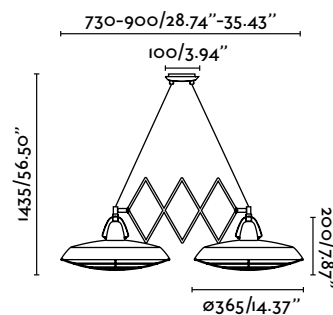
[new]

Pendant Lamp

LED EXTENSIBLE IP44

Ref.	66214		rust brown marrón óxido
	66215		off white blanco roto
Bulb	SMD LED 30W 2700K 2400Lm incl.		
Materials	Steel + PVC Acero + PVC		
V/Hz	220-240V / 50-60 Hz		
EEL	A++ to A		
Weight	4.2 kg / 9.26 lb		

+ info



Winch


Design: Àlex&Manel
Llusçà



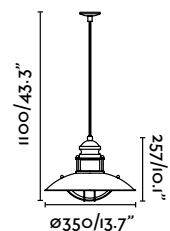
Inspired by the gas lamps of the old fishing boats from the Mediterranean coast, it gives memories and calmness to all its surroundings.



Pendant Lamp


Ref.	66204  pale brown marrón pardo
Bulb	1xE27 max 60W not incl. [LED 17453]
Materials	Metal + Glass Metal + Cristal
V/Hz	100-240V / 50-60 Hz
EEL	A++ to E
Weight	2.4 kg / 5.29 lb

+ info

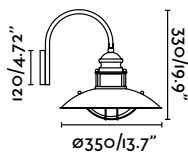
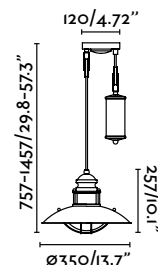





Pendant Lamp

Ref.	66205	 pale brown marrón pardo
Bulb	1xE27 max 60W not incl. [LED 17453]	
Materials	Metal + Glass Metal + Cristal	
V/Hz	100-240V / 50-60 Hz	
EEL	A++ to E	
Weight	5 kg / 11.02 lb	

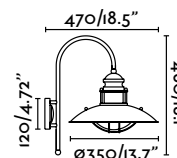
+ info




Wall Lamp

Ref.	66200	 pale brown marrón pardo
Bulb	1xE27 max 60W not incl. [LED 17453]	
Materials	Metal + Glass Metal + Cristal	
V/Hz	100-240V / 50-60 Hz	
EEL	A++ to E	
Weight	2.5 kg / 5.51 lb	

+ info



Wall Lamp

Ref.	66201	 pale brown marrón pardo
Bulb	1xE27 max 60W not incl. [LED 17453]	
Materials	Metal + Glass Metal + Cristal	
V/Hz	100-240V / 50-60 Hz	
EEL	A++ to E	
Weight	2.7 kg / 5.95 lb	

+ info



Sac



Design: Àlex&Manel
Llusçà

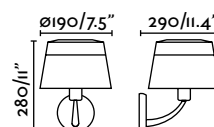


The Sac family exudes a rustic feeling with a contemporary design combining a textured metal structure and a fabric shade that provides a soft, warm light.

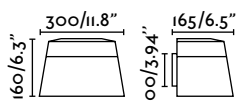


Wall Lamp



Ref.	66190	 	dark brown+beige marrón oscuro+beige
Bulb	1xE27 max 60W not incl. [LED 17452]		
Materials	Metal + Textile Metal + Tèxtil		
V/Hz	100-240V / 50-60 Hz		
EEI	A++ to E		
Weight	1.13 kg / 2.49 lb		



+ info 



Wall Lamp

Ref.	66191	 	dark brown+beige marrón oscuro+beige
Bulb	2xE14 max 60W not incl. [LED 17451]		
Materials	Metal + Textile Metal + T�xtil		
V/Hz	100-240V / 50-60 Hz		
EEL	A++ to E		
Weight	0.8 kg / 1.76 lb		

+ info

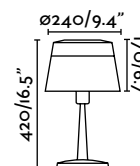




Table Lamp

Ref.	66194	 	dark brown+beige marr�n oscuro+beige
Bulb	1xE27 max 60W not incl. [LED 17452]		
Materials	Metal + Textile Metal + T�xtil		
V/Hz	100-240V / 50-60 Hz		
EEL	A++ to E		
Weight	2 kg / 4.41 lb		

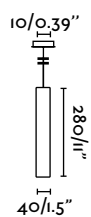
+ info



Lise



Lise is an indoor lighting set comprising one spotlight, one wall lamp and one pendant lamp, with black or white finish.



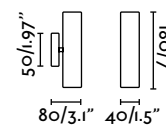


Pendant Lamp

LED

Ref.	29886		white blanco
	29887		black negro
Bulb	COB LED 6W 2700K 370Lm CRI>80 incl.		
Materials	Aluminium Aluminio		
V/Hz	100-240V / 50-60 Hz		
EEL	A+		
Weight	0.75 kg / 1.65 lb		



+ info



Wall Lamp

LED

UP & DOWN
ARRIBA Y ABAJO

Ref.	29888		white blanco
	29889		black negro
Bulb	COB LED 12W 2700K 740Lm CRI>80 incl.		
Materials	Aluminium Aluminio		
V/Hz	100-240V / 50-60 Hz		
EEL	A+		
Weight	0.51 kg / 1.12 lb		

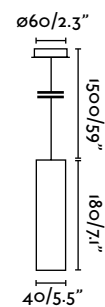
+ info



Ora



Ora is an indoor lighting set comprising one spotlight, one wall lamp and one pendant lamp, with black or white finish.



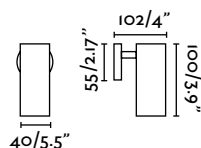


Pendant Lamp

LED



Ref.	29894	 white blanco
	29895	 black negro
Bulb	SMD LED 4W 3000K 350Lm CRi80 incl.	
Materials	Aluminium + Metal + PMMA Aluminio + Metal + PMMA	
V/Hz	220-240V / 50-60 Hz	
EEl	A++	
Weight	0.38 kg / 0.84 lb	

+ info



Wall Lamp

LED

Ref.	29890	 white blanco
	29891	 black negro
Bulb	SMD LED 4W 3000K 350Lm CRi80 incl.	
Materials	Aluminium + Metal + PMMA Aluminio + Metal + PMMA	
V/Hz	220-240V / 50-60 Hz	
EEl	A++	
Weight	0.25 kg / 0.55 lb	

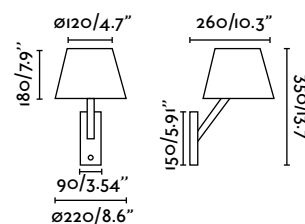
+ info







Moma

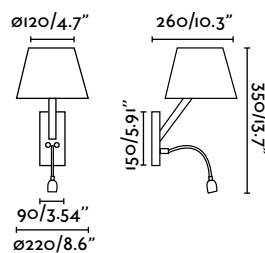
Collection for indoor lighting made from steel and a textile shade.








Wall Lamp

Ref.	68504			chrome+white cromo+blanco
	68505			chrome+black cromo+negro
Bulb	1 x E27 max 60W not incl. [LED 17452]			
Materials	Metal + Textile Metal + T��xtil			
V/Hz	100-240V / 50-60 Hz			
EEL	A++ to E			
Weight	1.4 kg / 3.09 lb			

+ info  


Wall Lamp + Reader

Ref.	68506			chrome+white cromo+blanco
	68507			chrome+black cromo+negro
Bulb	1 x E27 max 60W not incl. [LED 17452] HIGH POWER LED 1W 6000K 80Lm incl.			
Materials	Metal + Textile Metal + T��xtil			
V/Hz	100-240V / 50-60 Hz			
EEL	A++ to E			
Weight	1.6 kg / 3.53 lb			





+ info   







Floor Lamp

Ref.	68502			chrome+white cromo+blanco
	68503			chrome+black cromo+negro

Bulb 1xE27 max 60W not incl. [LED 17453]

Materials Metal + Textile + Opal PVC
Metal + T extil + PVC Opal

V/Hz 100-240V / 50-60 Hz

EEI A++ to E

Weight 9.8 kg / 21.61 lb

+ info

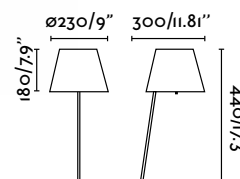






Table Lamp

Ref.	68500			chrome+white cromo+blanco
	68501			chrome+black cromo+negro

Bulb 1xE27 max 60W not incl. [LED 17452]

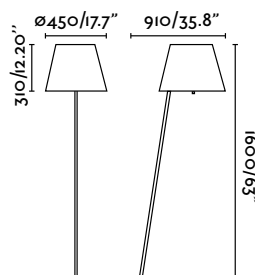
Materials Metal + Textile + Opal PVC
Metal + T extil + PVC Opal

V/Hz 100-240V / 50-60 Hz

EEI A++ to E

Weight 2.8 kg / 6.17 lb

+ info




Creta

Collection for indoor lighting made from metal with a textile shade.

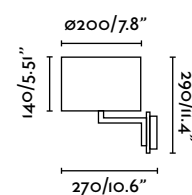


Wall Lamp

Ref.	68515		matt nickel+white níquel mate+blanco
Bulb	1xE27 max 60W not incl. [LED 17453]		
Materials	Metal + Textile Metal + T�xtil		
V/Hz	100-240V / 50-60 Hz		
EEl	A++ to E		
Weight	1.08 kg / 2.38 lb		

+ info 

HF



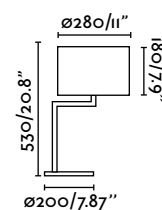


Table Lamp

Ref.	68513		HF
Bulb	1xE27 max 60W not incl. [LED 17453]		
Materials	Metal + Textile Metal + Tèxtil		
V/Hz	100-240V / 50-60 Hz		
EEl	A++ to E		
Weight	4.11 kg / 9.06 lb		

+ info



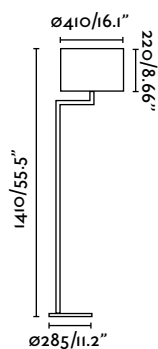
Floor Lamp

Ref.	68514	
Bulb	1xE27 max 60W not incl. [LED 17453]	
Materials	Metal + Textile Metal + Tèxtil	
V/Hz	100-240V / 50-60 Hz	
EEl	A++ to E	
Weight	7.46 kg / 16.45 lb	

+ info



HF



HF Until stock exhaustion
Hasta final de stock
Jusqu'à la fin de stock

Thana

Collection for indoor lighting: Wall lamp, table lamp, pendant and floor lamp. In matt nickel and white textile shade.





Floor Lamp

Ref. 68531   matt nickel+white
níquel mate+blanco

Bulb 1xE27 max 100W not incl. [LED 17453]

Materials Metal + Textile
Metal + T xtil

V/Hz 100-240V / 50-60 Hz

EEL A++ to E

Weight 3.9 kg / 8.60 lb

+ info

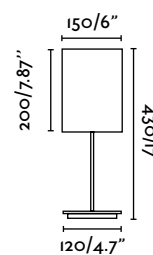


Table Lamp

Ref. 68530   matt nickel+white
níquel mate+blanco

Bulb 1xE27 max 40W not incl. [LED 17452]

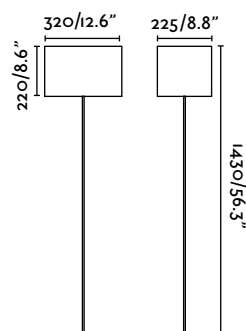
Materials Metal + Textile
Metal + T xtil

V/Hz 100-240V / 50-60 Hz

EEL A++ to E

Weight 1.3 kg / 2.87 lb

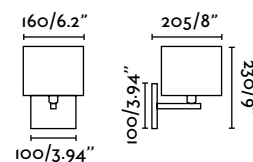
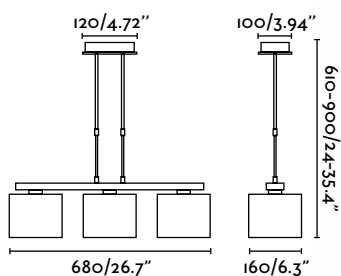
+ info





**Pendant
Lamp****TELESCOPIC
TELESCÓPICO****Ref.** 68533   matt nickel+white
níquel mate+blanco**Bulb** 3xE27 max 40W not incl. [LED 17453]**Materials** Metal + Textile
Metal + T xtil**V/Hz** 100-240V / 50-60 Hz**EEL** A++ to E**Weight** 3.04 kg / 6.70 lb

+ info

**Wall
Lamp****Ref.** 68532   matt nickel+white
niquel mate+blanco**Bulb** 1xE14 max 40W not incl. [LED 17451]**Materials** Metal + Textile
Metal + T xtil**V/Hz** 100-240V / 50-60 Hz**EEL** A++ to E**Weight** 0.8 kg / 1.76 lb

+ info



Mitic

Mitic is an indoor collection made of steel and beige textile. Wall lamp, pendant, table lamp and floor lamp.



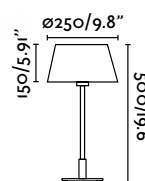


Table Lamp

Ref. **68417**   matt nickel+beige
níquel mate+beige

Bulb 1xE14 max 60W not incl. [LED 17451]

Materials Metal + Textile
Metal + Tèxtil

V/Hz 100-240V / 50-60 Hz

EEl A++ to E

Weight 1.77 kg / 3.90 lb

+ info



Floor Lamp

Ref. **68418**   matt nickel+beige
níquel mate+beige

Bulb 1xE27 max 60W not incl. [LED 17453]

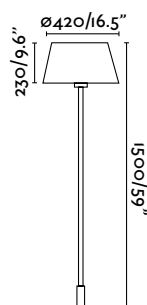
Materials Metal + Textile
Metal + Tèxtil

V/Hz 100-240V / 50-60 Hz

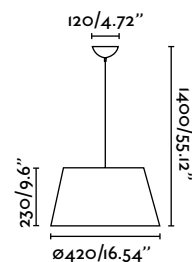
EEl A++ to E

Weight 4 kg / 8.82 lb



+ info



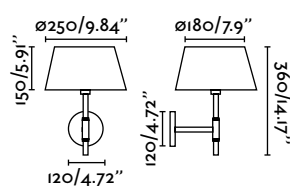






Pendant Lamp

Ref.	68419	 	matt nickel+beige níquel mate+beige
Bulb	1xE27 max 60W not incl. [LED 17453]		
Materials	Metal + Textile Metal + Tèxtil		
V/Hz	100-240V / 50-60 Hz		
EEL	A++ to E		
Weight	1.7 kg / 3.75 lb		

+ info



Wall Lamp

Ref.	68420	 	matt nickel+beige níquel mate+beige
Bulb	1xE14 max 60W not incl. [LED 17451]		
Materials	Metal + Textile Metal + Tèxtil		
V/Hz	100-240V / 50-60 Hz		
EEL	A++ to E		
Weight	1 kg / 2.20 lb		

+ info





Lara

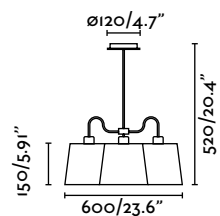
Lara is a family with a metal frame in chrome and white fabric shade.

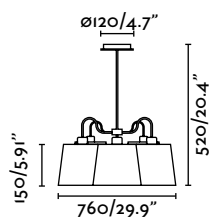


Pendant Lamp



Ref.	67019	 	chrome+white cromo+blanco	HF
Bulb	3xE14 max 40W not incl. [LED 17451]			
Materials	Metal + Textile Metal + Tèxtil			
V/Hz	100-240V / 50-60 Hz			
EEI	A++ to E			
Weight	1.37 kg / 3.02 lb			

+ info 

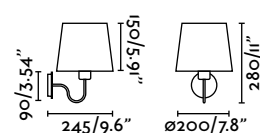






Pendant Lamp

Ref.	67020	 	chrome+white cromo+blanco	HF
Bulb	5xE14 max 40W not incl. [LED 17451]			
Materials	Metal + Textile Metal + T�xtil			
V/Hz	100-240V / 50-60 Hz			
EEL	A++ to E			
Weight	1.94 kg / 4.28 lb			

+ info 



Wall Lamp

Ref.	67018	 	chrome+white cromo+blanco	HF
Bulb	1xE14 max 40W not incl. [LED 17451]			
Materials	Metal + Textile Metal + T�xtil			
V/Hz	100-240V / 50-60 Hz			
EEL	A++ to E			
Weight	0.18 kg / 0.40 lb			

+ info 


HF Until stock exhaustion
Hasta final de stock
Jusqu'  la fin de stock


Saba

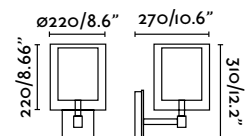
Saba has a double shade and a metal structure finished in matt nickel. Wall lamp, table lamps, floor lamp and pendant lamps.




Wall Lamp

Ref.	68544	 matt nickel níquel mate
Bulb	1xE27 max 40W not incl. [LED 17453]	
Materials	Steel + Textile Acero + Tèxtil	
V/Hz	100-240V / 50-60 Hz	
EEL	A++ to E	
Weight	1.6 kg / 3.53 lb	

+ info 





Floor Lamp

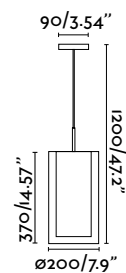
Ref.	68547  matt nickel níquel mate
Bulb	1xE27 max 60W not incl. [LED 17458]
Materials	Steel + Textile Acero + T�xtil
V/Hz	100-240V / 50-60 Hz
EEl	A++ to E
Weight	3.5 kg / 7.72 lb


+ info


Pendant Lamp

Ref.	68548  matt nickel níquel mate
Bulb	1xE27 max 40W not incl. [LED 17458]
Materials	Steel + Textile Acero + T�xtil
V/Hz	100-240V / 50-60 Hz
EEl	A++ to E
Weight	1.5 kg / 3.31 lb

+ info

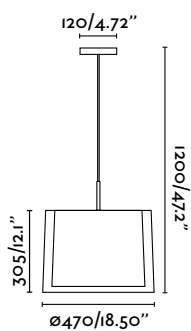

Table Lamp




Ref.	68545  matt nickel níquel mate
Bulb	1xE27 max 40W not incl. [LED 17453]
Materials	Steel + Textile Acero + T�xtil
V/Hz	100-240V / 50-60 Hz
EEl	A++ to E
Weight	1.8 kg / 3.97 lb

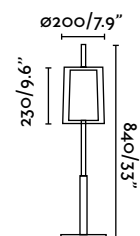
+ info










**Pendant
Lamp**

Ref.	68549	 matt nickel níquel mate
Bulb	3xE27 max 40W not incl. [LED 17458]	
Materials	Steel + Textile + Opal PVC Acero + T�xtil + PVC Opal	
V/Hz	100-240V / 50-60 Hz	
EEL	A++ to E	
Weight	2.2 kg / 4.85 lb	
+ info		


**Table
Lamp**

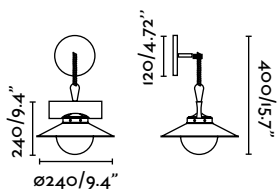
Ref.	68546	 matt nickel níquel mate	
Bulb	1xE27 max 40W not incl. [LED 17453]		
Materials	Steel + Textile Acero + T�xtil		
V/Hz	100-240V / 50-60 Hz		
EEL	A++ to E		
Weight	1.8 kg / 3.97 lb		
+ info			




Nudos

Family of nautical-inspired lamps made of metal and wood. The diffuser is made of a glass bubble.

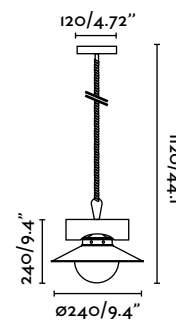





Wall Lamp

Ref.	68138  dark brown marrón oscuro
Bulb	1xE27 max 60W not incl. [LED 17458]
Materials	Metal + Wood + Bubble Glass Metal + Madera + Cristal Burbuja
V/Hz	100-240V / 50-60 Hz
EEL	A++ to E
Weight	1.3 kg / 2.87 lb

+ info



Pendant Lamp

Ref.	68139  dark brown marrón oscuro
Bulb	1xE27 max 60W not incl. [LED 17458]
Materials	Metal + Wood + Bubble Glass Metal + Madera + Cristal Burbuja
V/Hz	100-240V / 50-60 Hz
EEL	A++ to E
Weight	1.36 kg / 3.00 lb

+ info



Akane	106
Banker	112
Black	117
Bliss	111
Chapí	113
Dix	121
Hat	111
Lula	104
Nexo	114
Nidia	113
Papua	119
Roma	117
Versus	108

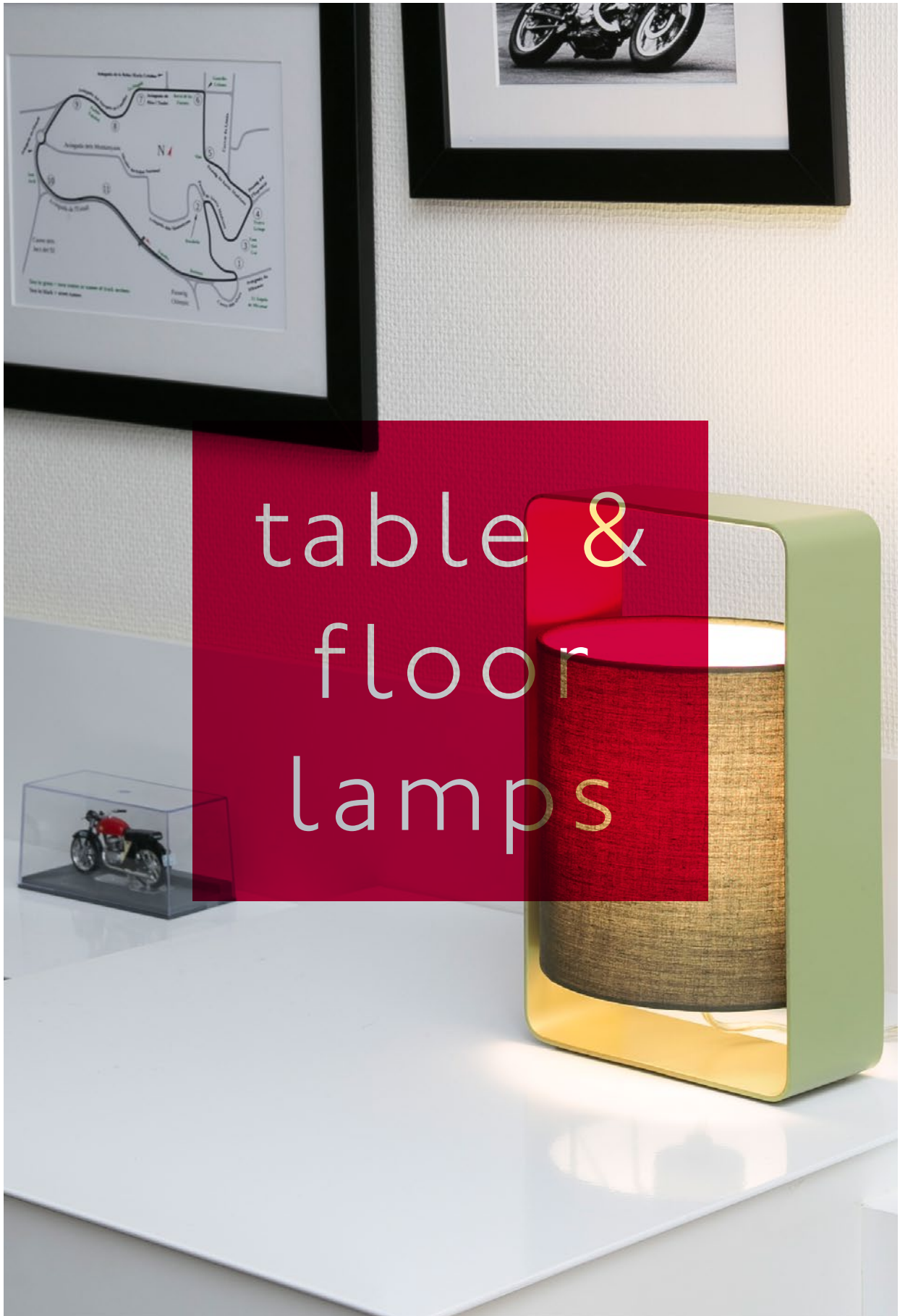


table &
floor
lamps

Lula

Design: Marina Milà













Lula is a sculptural table lamp, light, with soft shapes, pleasant to look at and austere, without superfluous elements. Its simplicity gives it that beauty and style that characterizes its design.





Table Lamp

Ref.	28380	 	white+ white blanco+ blanco
	28381	 	olive green+dark green verde oliva+verde oscuro
	28382	 	black+white negro+blanco
Bulb	1xE27 max 20W not incl. [LED 17453]		
Materials	Metal + Textile Metal + T��xtil		
V/Hz	100-240V / 50-60 Hz		
EEL	A++ to B		
Weight	2.25 kg / 4.96 lb		
+ info	   		

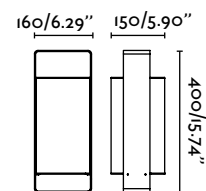












Table Lamp

Ref.	28383	 	white+ white blanco+ blanco
	28384	 	olive green+dark green verde oliva+verde oscuro
	28385	 	black+white negro+blanco
Bulb	1xE27 max 20W not incl. [LED 17453]		
Materials	Metal + Textile Metal + T��xtil		
V/Hz	100-240V / 50-60 Hz		
EEL	A++ to B		
Weight	2.32 kg / 5.11 lb		
+ info	   		

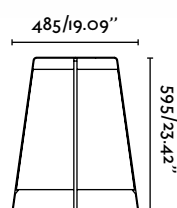
Akane

Design: Pepe Llaudet





Inspired by the most ancient oriental culture and reinterpreted to be converted into a contemporary object, Akane constantly surprises thanks to the minimalism of its useful structure.



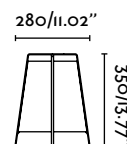


MADE IN SPAIN
HECHO EN ESPAÑA

Table Lamp



Ref.	28371	 	black+beige negro+beige
Bulb	1xE27 max 20W not incl. [LED 17458]		
Materials	Metal + Papyrus Metal + Papiro		
V/Hz	100-240V / 50-60 Hz		
EEL	A++ to B		
Weight	3.64 - 6.61 lb		

+ info



MADE IN SPAIN
HECHO EN ESPAÑA

Table Lamp

Ref.	28370	 	black+beige negro+beige
Bulb	1xE27 max 20W not incl. [LED 17453]		
Materials	Metal + Papyrus Metal + Papiro		
V/Hz	100-240V / 50-60 Hz		
EEL	A++ to B		
Weight	1.65 - 3 kg		

+ info



Versus

Design: Pepe Llaudet



Simple,
easily-integrated
and versatile. A
contemporary
object with a classic
geometrical design
formed from two conical
elements of the same
type and material.



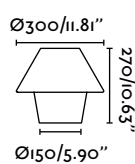






Table Lamp	
Ref.	29906  white blanco
Bulb	1 x E27 max 60W not incl. [LED 17452]
Materials	Textile Téxtil
V/Hz	100-240V / 50-60 Hz
EEL	A++ to E
Weight	1 kg / 2.20 lb
+ info	  

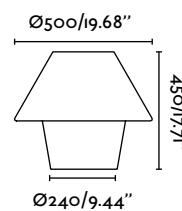




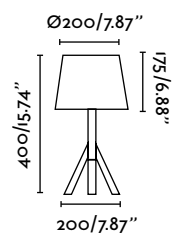




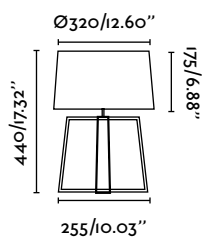
Table Lamp	
Ref.	29907  white blanco
Bulb	1 x E27 60W not incl. [LED 17453]
Materials	Textile Téxtil
V/Hz	100-240V / 50-60 Hz
EEL	A++ to E
Weight	2 kg / 4.41 lb
+ info	  





**HAT****Table Lamp**

Ref.	28408	 	wood+white madera+blanco
Bulb	1xE14 max 40W not incl. [LED 17451]		
Materials	Wood + Textile Madera + T��xtil		
V/Hz	100-240V / 50-60 Hz		
EEl	A++ to E		
Weight	0.7 kg / 1.54 lb		

+ info

**BLISS****Table Lamp**

Ref.	28401	 	wood+white madera+blanco
Bulb	1xE27 max 60W not incl. [LED 17453]		
Materials	Wood + Metal + Textile Madera + Metal + T��xtil		
V/Hz	100-240V / 50-60 Hz		
EEl	A++ to E		
Weight	1.58 kg / 3.48 lb		

+ info



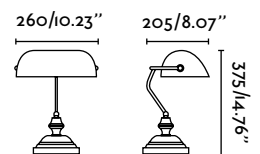


BANKER

Table Lamp



Ref.	68333	 bronze bronce
	68334	 old gold oro envejecido
Bulb	1 x E27 max 60W not incl. [LED 17453]	
Materials	Metal + Glass Metal + Cristal	
V/Hz	100-240V / 50-60 Hz	
EEL	A++ to E	
Weight	2.3 kg / 5.07 lb	

+ info

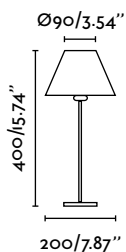


NIDIA

Table Lamp

Ref.	68423	 	matt nickel+beige níquel mate+beige
Bulb	1xE27 max 40W not incl. [LED 17452]		
Materials	Metal + Linen Metal + Lino		
V/Hz	100-240V / 50-60 Hz		
EEL	A++ to E		
Weight	0.9 kg / 1.98 lb		



+ info



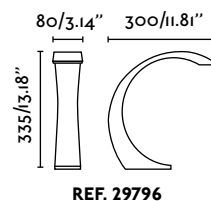
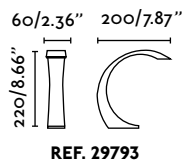
CHAPÍ

Table Lamp

TOUCH LAMP
LAMPARA TÁCTIL

Ref.	29793		chrome cromo
	29796		chrome cromo
Bulb	LED 3W 3000K 140Lm incl.		
Materials	Stainless Steel Acero Inoxidable		
V/Hz	220-240V / 50 Hz		
EEL	A		
Weight	1.1 kg / 2.43 lb		

+ info



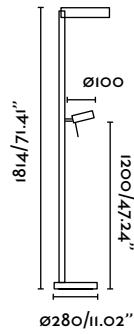
Nexo

Design: Estudi Ribaudf





Nexo is an ambient light which incorporates a spotlight. Light flows through a single element that directs it in a gentle and balanced composition.





Floor Lamp + Reader

- Ref.** **57205**  matt nickel
níquel mate
- 57207**  black
negro

Bulb 2xE27 max 15W not incl. [LED 17453]
1xG9 max 26W incl.

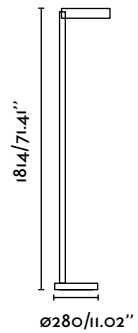
Materials Metal + Translucent Glass
Metal + Cristal Translúcido

V/Hz 100-240V / 50-60 Hz




EEL A++ to E

Weight 7.2 kg / 15.87 lb

+ info



Floor Lamp

- Ref.** **57200**  matt nickel
níquel mate
- 57201**  white
blanco
- 57202**  black
negro

Bulb 2xE27 max 15W not incl. [LED 17453]

Materials Metal + Translucent Glass
Metal + Cristal Translúcido

V/Hz 100-240V / 50-60 Hz

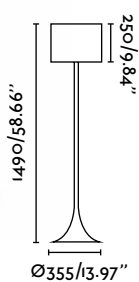
EEL A++ to B

Weight 7.2 kg / 15.87 lb

+ info





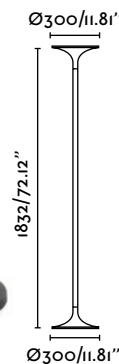


BLACK

Floor Lamp

Ref.	29764 ● black negro
Bulb	1xE27 max 60W not incl. [LED 17458]
Materials	Metal + Textile Metal + T�xtil
V/Hz	100-240V / 50-60 Hz
EEl	A++ to E
Weight	2.5 kg / 5.51 lb

+ info   



ROMA

Floor Lamp

LED **DIMMABLE**

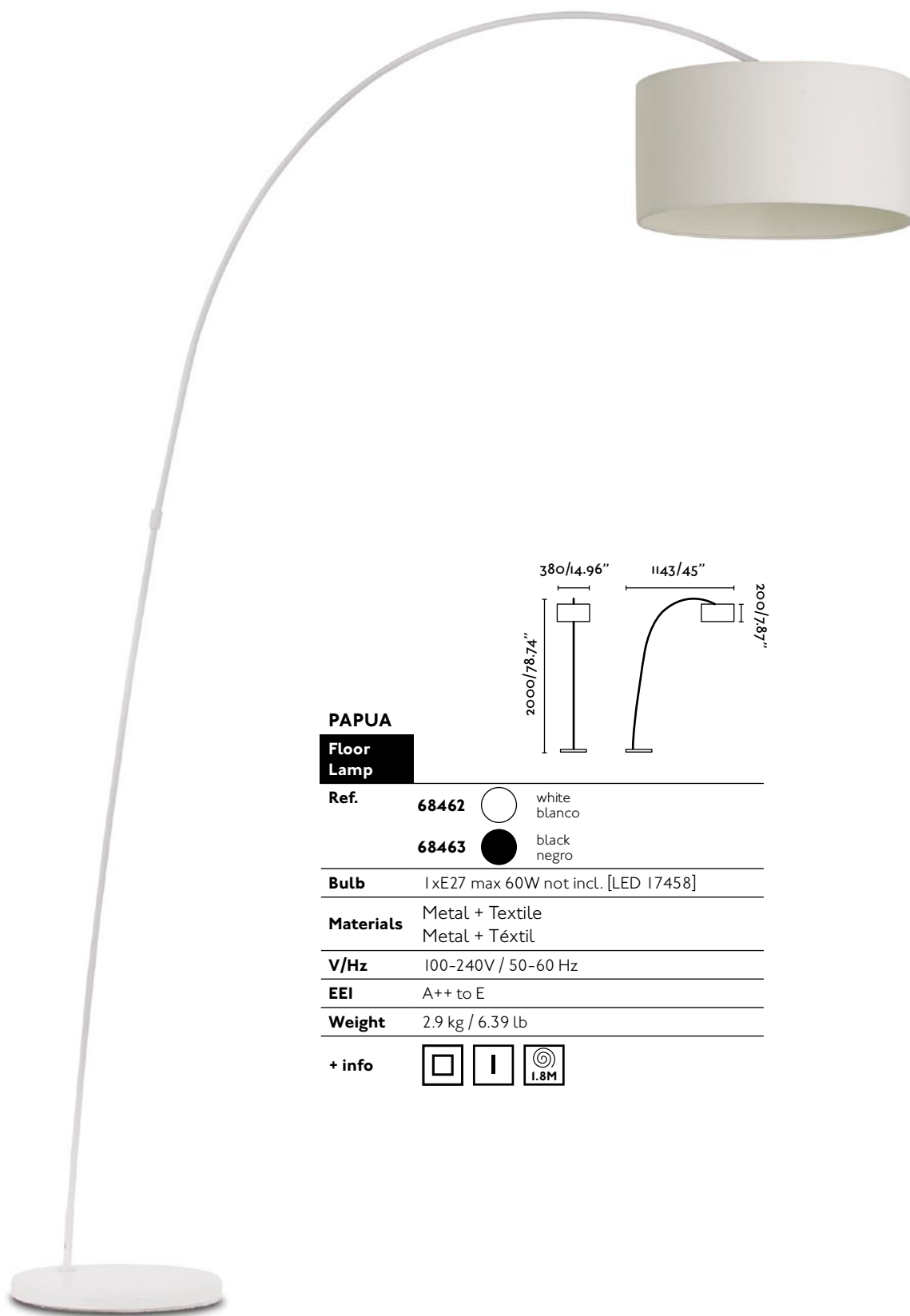
Ref.	57069 ● black negro
Bulb	COB LED 22W 3000K 2050Lm CRI>80 incl.
Materials	Metal Metal
V/Hz	220-240V / 50-60 Hz
EEl	A+
Weight	8.5 kg / 18.74 lb

+ info  **DRIVER**    

HF

HF Until stock exhaustion
Hasta final de stock
Jusqu'  la fin de stock



**PAPUA****Floor
Lamp**

Ref.	68462		white blanco
	68463		black negro

Bulb 1xE27 max 60W not incl. [LED 17458]

Materials Metal + Textile
Metal + T xtil

V/Hz 100-240V / 50-60 Hz

EEL A++ to E

Weight 2.9 kg / 6.39 lb

+ info







DIX

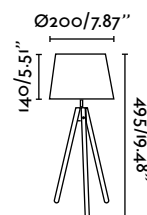
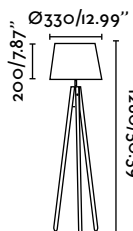
Floor Lamp

Ref.	28407 ● black negro
Bulb	1xE27 max 60W not incl. [LED 17458]
Materials	Wood + Textile Madera + T�xtil
V/Hz	100-240V / 50-60 Hz
EEL	A++ to E
Weight	1.8 kg / 3.97 lb

+ info



HF



DIX

Table Lamp

Ref.	28406 ● black negro
Bulb	1xE14 max 40W not incl. [LED 17451]
Materials	Wood + Textile Madera + T�xtil
V/Hz	100-240V / 50-60 Hz
EEL	A++ to E
Weight	0.8 kg / 1.76 lb

+ info



HF

HF Until stock exhaustion
Hasta final de stock
Jusqu'  la fin de stock

More table lamps



Berni
29



Creta
85



Hotel
45



Linda
59



Link
67



Lupe
31



Mitic
91



Mix
54



Moma
83



Retro
21



Saba
97



Sac
75



Sweet
49



Thana
87



Tree
52



Vesper
40



Volta
39

More floor lamps



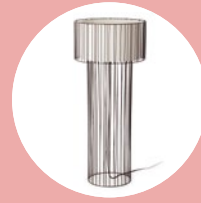
Berni
29



Creta
85



Hotel
45



Linda
59



Link
67



Lupe
31



Mitic
91



Moma
83



Retro
21



Saba
97



Sweet
49



Thana
87



Tree
53



Volta
39

Aina	159	Mali	161	Rose	152
Alder	167	Margot	153	Seven	157
Alma	151	Marlin	145	Siria	169
Aluminio	170	Mia	163	Squad	141
Art	149	Murano	160	Tavern	153
Bar	167	Nan	141	Tempo	142
Bongo	173	Nanko	165	Transfer	175
Charlotte	169	Nido	155		
Cilo	171	Nitro	173		
Clara	151	Óleo	175		
Coccote	130	Pam	143		
Cráter	165	Papillon	132		
Erma	149	Pauline	126		
Halita	145	Pérgamo	154		
Liana	155	Planet	128		
Liz	147	Platillo	171		
Luce	163	Pluma	134		
Magma	137	Prosa	159		



Pauline [new]

Design: Nahtrang



The research between the warmth and comfort are exemplified in this delicate creation. The light comes out through the wood, creating a magical atmosphere.






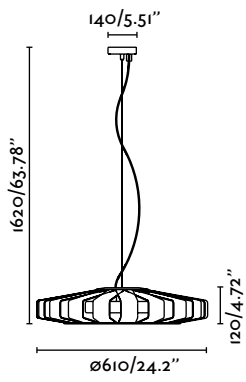
[new]

Pendant Lamp

LED DIMMABLE DIMMABLE

Ref.	20100	 wood maderas
Bulb	SMD LED 24W 2700K 2000Lm incl.	
Materials	Wood + Metal Madera + Metal	
V/Hz	220-240V / 50-60 Hz	
EEL	A++ to A	
Weight	4.2 kg / 9.26 lb	

+ info    

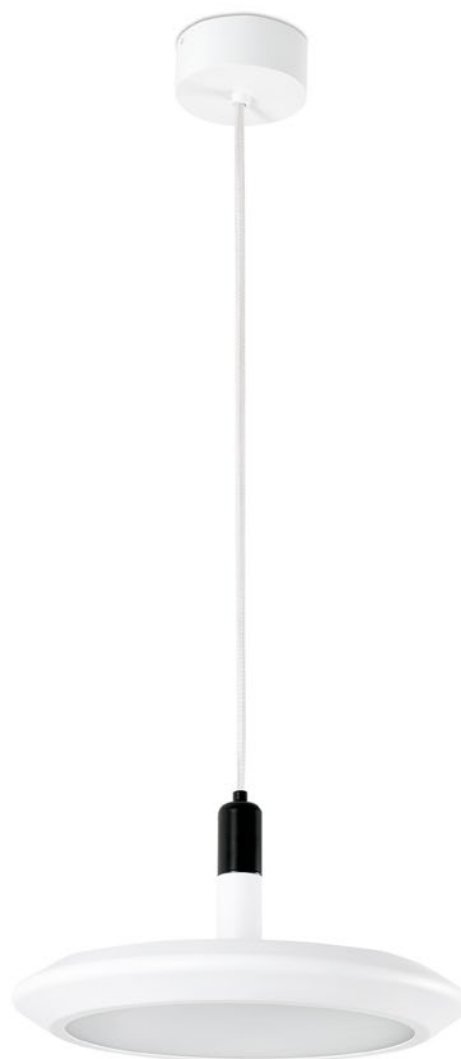


Planet [new]

Design: Xjer Studio

A suspension
with personality,
strong and elegant, like
the universe itself.







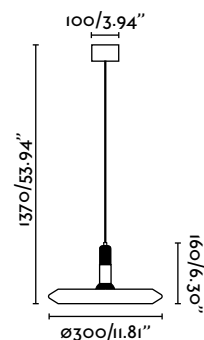
PLANET [new]

Pendant Lamp

LED

Ref.	65046	 white blanco
	65047	 copper cobre
Bulb	SMD LED 12W 3000K 780Lm incl.	
Materials	Metal + Aluminium + Acrylic Metal + Aluminio + Acrílico	
V/Hz	100-240V / 50-60 Hz	
EEL	A++ to A	
Weight	1.48 kg / 3.26 lb	

+ info

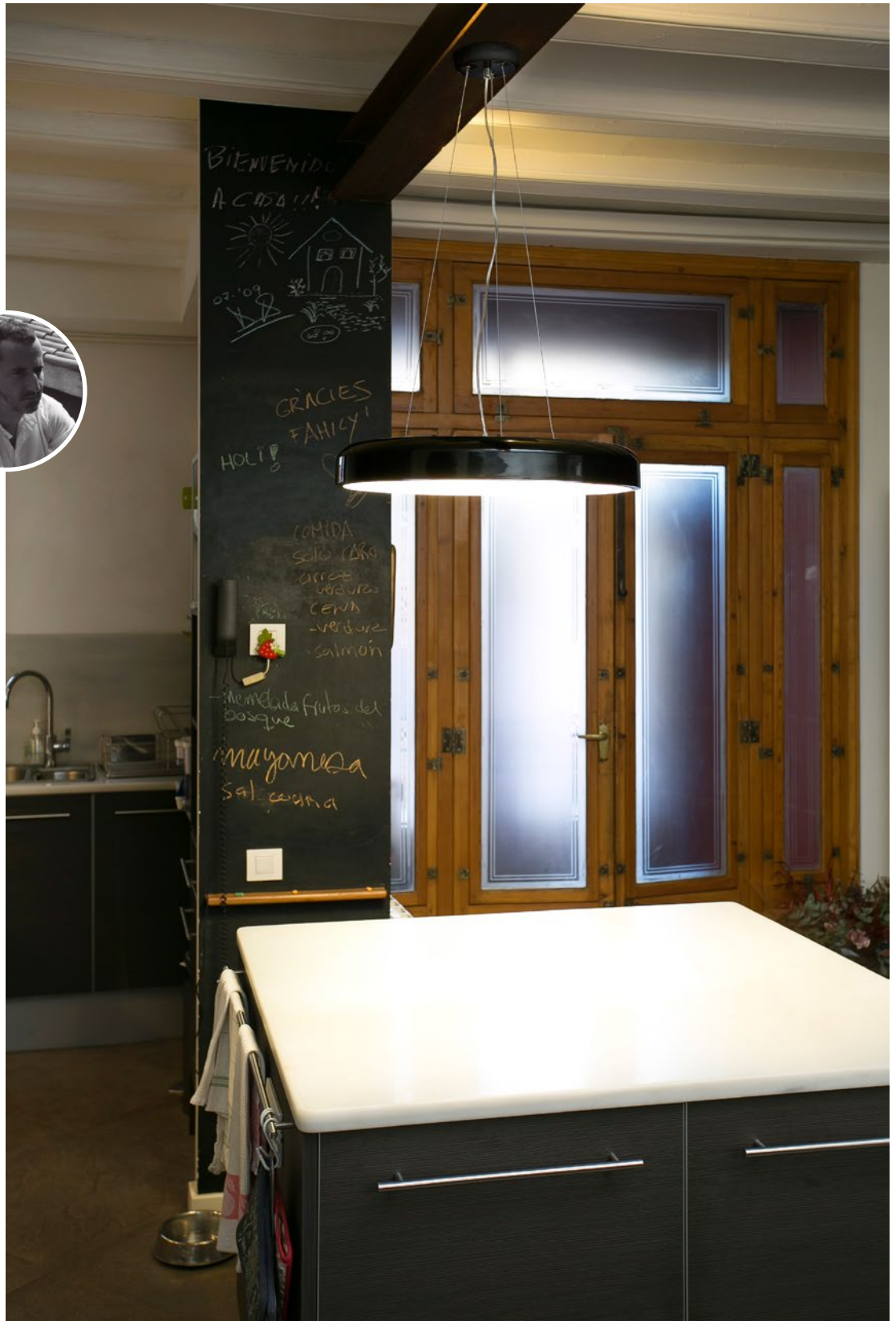


Cocote

Design: Jordi Llopis



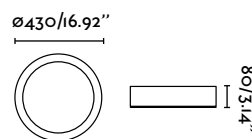
An elegant piece with character, while sober and timeless. Cocotte is characterized by giving the same importance to the diffuser that projects light as to the metal mounting base.







additional kit

Example 64181 + 64185





Ceiling Lamp-p

Ref.	64180		matt white blanco mate
	64181		shiny black negro brillante
Bulb	1xT5 max 40W not incl. [9724040]		
Materials	Metal + Opal Acrylic Metal + Acrílico Opal		
V/Hz	220-240V / 50-60 Hz		
EEL	A to B		
Weight	1.97 kg / 4.34 lb		

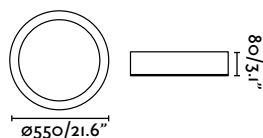
+ info  **BALLAST** 

Suspension Kit Accessory -P
Kit Suspensión Accesorio -P

64184		white blanco
64185		black negro





For 64180 and 64181 / Para refs. 64180 y 64181





Ceiling Lamp-g

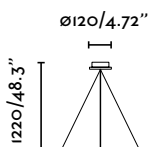
LED

Ref.	64182		matt white blanco mate
	64183		shiny black negro brillante
Bulb	SMD LED 42W 2700K 1900Lm incl.		
Materials	Metal + Opal Acrylic Metal + Acrílico Opal		
V/Hz	100-240V / 50-60 Hz		
EEL	A		
Weight	2.81 kg / 6.19 lb		

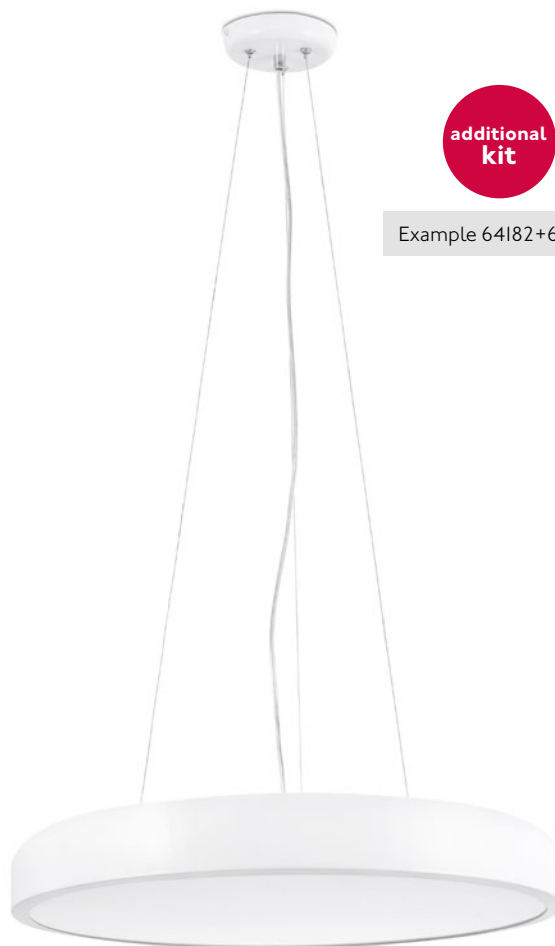
+ info  **DRIVER** 

Suspension Kit Accessory -G
Kit Suspensión Accesorio -G

64186		white blanco
64187		black negro



For 64182 and 64183 / Para refs. 64182 y 64183



additional kit

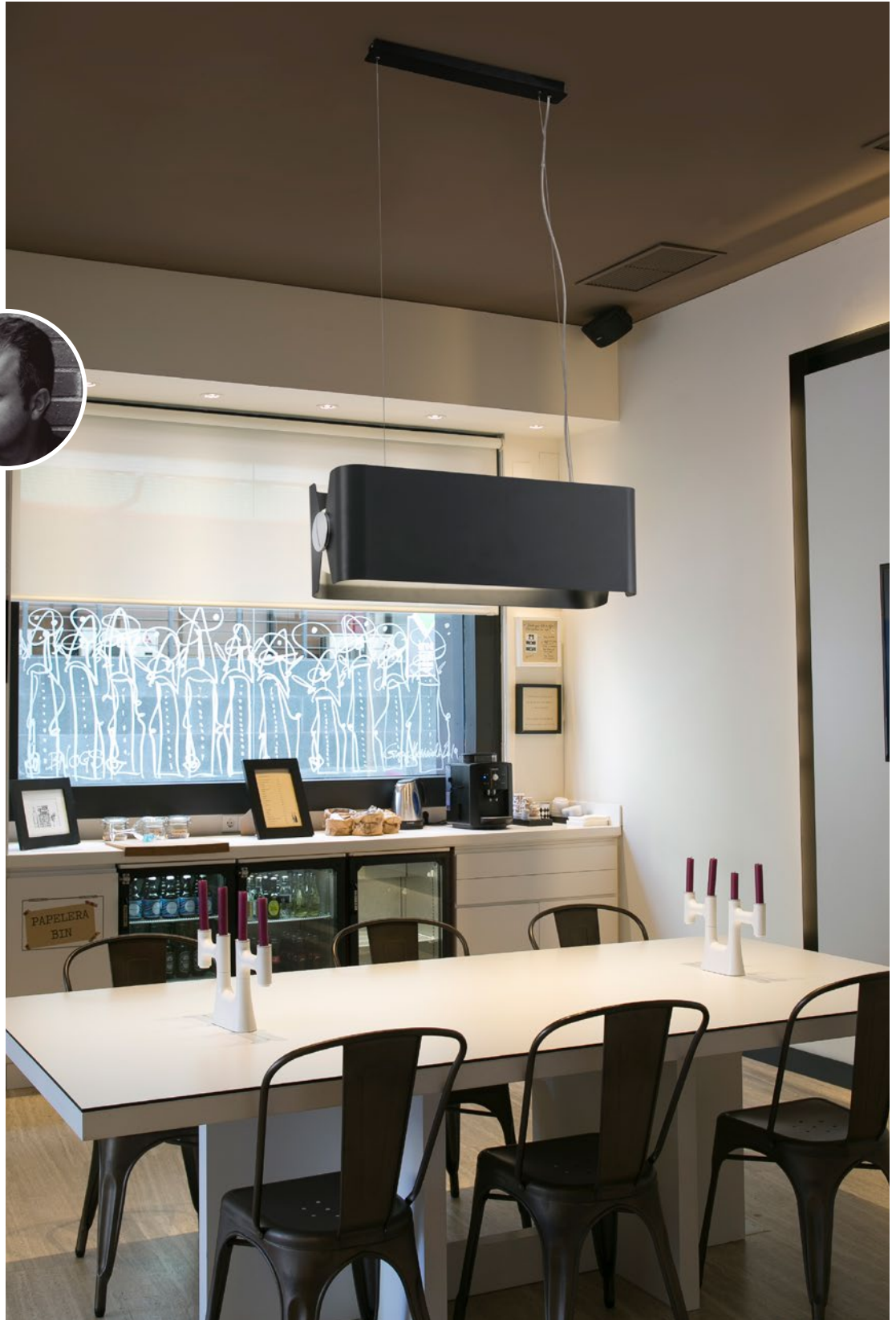
Example 64182 + 64186

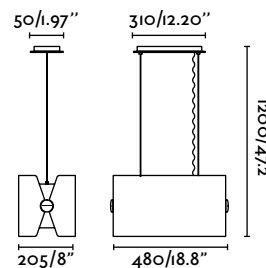
Papillon

Design: Jordi Busquets



An elegant suspension. Perfect for environments with different lighting requirements.





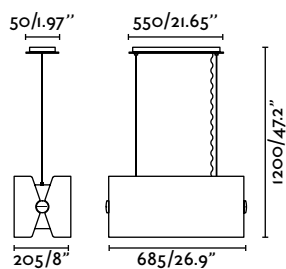
Pendant Lamp-p

Ref.	29294		white blanco
	29295		black negro

Bulb	2xE27 20W not incl. [LED 17457]
Materials	Aluminium + Opal Polycarbonate Aluminio + Policarbonato Opal
V/Hz	100-240V / 50-60 Hz
EEl	A++ to B
Weight	3.6l kg / 7.96 lb

+ info

ADJUSTABLE SHADE
PANTALLA REGULABLE



Pendant Lamp-g

Ref.	29296		white blanco
	29297		black negro

Bulb	1xT5 14W not incl. [97400014]
Materials	Aluminium + Opal Polycarbonate Aluminio + Policarbonato Opal
V/Hz	220-240V / 50-60 Hz
EEl	A++ to B
Weight	5.0l kg / 11.05 lb

+ info



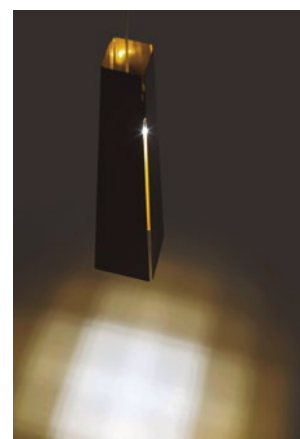
Pluma








Design: Nahtrang

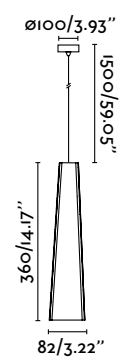


Pluma is a delicate piece. With a very light shape, the main body casts a small vertical slit through which a suggestive light comes out.

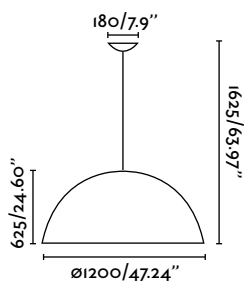




Pendant Lamp		LED	
Ref.	64170	 	white+ white blanco+ blanco
	64172	 	black+gold negro+oro
Bulb	SMD LED 6W 3000K 450Lm incl.		
Materials	Aluminium Aluminio		
V/Hz	220-240V / 50-60 Hz		
EEl	A++ to A		
Weight	0.6 kg / 1.32 lb		
+ info			







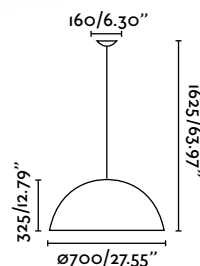


MAGMA

Pendant Lamp-g







Ref.	29789	 	black+gold negro+oro
Bulb	5xE27 max 40W not incl. [LED 17458]		
Materials	Fiber Glass Fibra De Vidrio		
V/Hz	100-240V / 50-60 Hz		
EEL	A++ to E		
Weight	22 kg / 48.50 lb		

+ info  



MAGMA

Pendant Lamp-p

Ref.	28398	 	white+silver blanco+plata
	28399	 	white+gold blanco+oro
	29468	 	black+gold negro+oro
Bulb	3xE27 max 60W not incl. [LED 17458]		
Materials	Fiber Glass Fibra De Vidrio		
V/Hz	100-240V / 50-60 Hz		
EEL	A++ to E		
Weight	8.2 kg / 18.08 lb		

+ info  






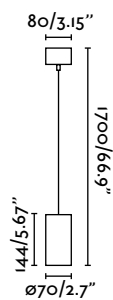
CUSTOMIZE
YOUR MAGMA ON
DEMAND
PERSONALIZAMOS
TU MAGMA BAJO
PETICIÓN




NAN**Pendant
Lamp**

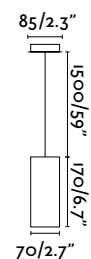
Ref.	64191  white blanco
Bulb	1xGU10 max 50W not incl. [LED 17324]
Materials	Aluminium Aluminio
V/Hz	100-240V / 50-60 Hz
EEl	A++ to E
Weight	0.51 kg / 1.12 lb

+ info

**SQUAD****Pendant
Lamp**

Ref.	63219  matt white blanco mate
Bulb	1xGU10 max 35W not incl. [LED 17316]
Materials	Aluminium + Steel Aluminio + Acero
V/Hz	100-240V / 50-60 Hz
EEl	A++ to E
Weight	0.75 kg / 1.65 lb

+ info











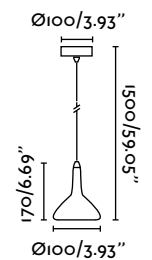
TEMPO

Pendant Lamp

LED

Ref.	64152	 	white+ white blanco+ blanco
	64153	 	black+gold negro+oro
	64154	 	black+silver negro+plata
Bulb	SMD LED 8W 3000K 600Lm incl.		
Materials	Aluminium Aluminio		
V/Hz	100-240V / 50-60 Hz		
EEL	A++		
Weight	0.4 kg / 0.88 lb		

+ info   







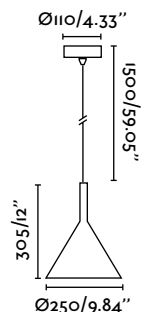
PAM

Pendant Lamp-g

LED

Ref.	64162	 	black+gold negro+oro
Bulb	SMD LED 24W 3000K 1875Lm incl.		
Materials	Aluminium Aluminio		
V/Hz	100-240V / 50-60 Hz		
EEl	A++		
Weight	0.61 kg / 1.34 lb		





+ info



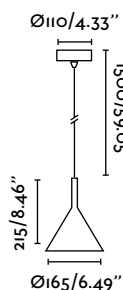
PAM

Pendant Lamp-p

LED

Ref.	64159	 	white+ white blanco+ blanco
	64160	 	black+gold negro+oro
Bulb	SMD LED 11W 3000K 900Lm incl.		
Materials	Aluminium Aluminio		
V/Hz	100-240V / 50-60 Hz		
EEl	A++		
Weight	0.7 kg / 1.54 lb		

+ info







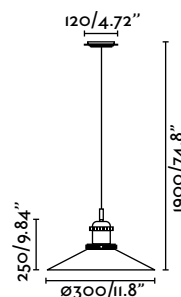


HALITA

Pendant Lamp





Ref.	65071	 	old gold+black oro envejecido+negro
Bulb	1xE27 max 60W not incl. [LED 17428]		
Materials	Metal + Glass Metal + Cristal		
V/Hz	100-240V / 50-60 Hz		
EEL	A++ to E		
Weight	1.14 kg / 2.51 lb		

+ info  

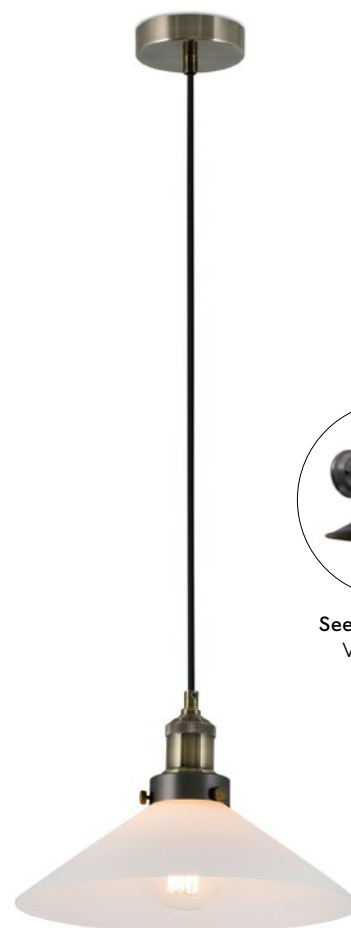
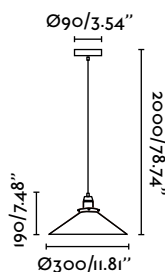


MARLIN

Pendant Lamp

Ref.	64133	 	old gold+black oro envejecido+negro
Materials	Metal Metal		
Ref.	64134	 	old gold+white oro envejecido+blanco
Bulb	1xE27 max 60W not incl. [LED 17428]		
Materials	Metal + Glass Metal + Cristal		
V/Hz	100-240V / 50-60 Hz		
EEL	A++ to E		
Weight	1.3 kg / 2.87 lb		

+ info  



See Wall Fixture
Ver Aplique
Pag_233

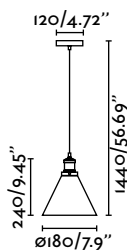


LIZ - 1 [new]

Pendant Lamp

Ref.	65079  old gold oro envejecido
Bulb	1xE27 60W not incl. [10310]
Materials	Metal + Glass Metal + Cristal
V/Hz	100-240V / 50-60 Hz
EEL	A++ to E
Weight	0.78 kg / 1.72 lb

+ info  

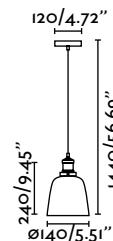


LIZ - 2 [new]

Pendant Lamp

Ref.	65080  old gold oro envejecido
Bulb	1xE27 60W not incl. [10310]
Materials	Metal + Glass Metal + Cristal
V/Hz	100-240V / 50-60 Hz
EEL	A++ to E
Weight	0.78 kg / 1.72 lb

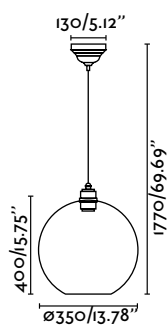
+ info  





ERMA [new]

Pendant Lamp

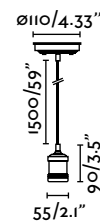


Ref.	65090	transparent transparente
Bulb	1xE27 100W not incl. [LED 17425]	
Materials	Metal + Textile + Glass Metal + T�extil + Cristal	
V/Hz	100-240V / 50-60 Hz	
EEL	A++ to E	
Weight	2.03 kg / 4.48 lb	

+ info



See Wall Fixture
Ver Aplique
Pag_233



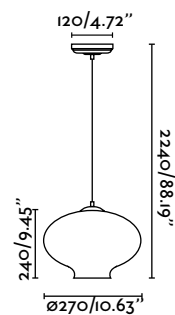
ART

Pendant Lamp

Ref.	64137	old gold oro envejecido
Bulb	1xE27 max 60W not incl. [LED 17425]	
Materials	Die Cast Aluminium + Textile + Steel Aluminio Inyectado + T�extil + Acero	
V/Hz	100-240V / 50-60 Hz	
EEL	A++ to E	
Weight	0.46 kg / 1.01 lb	

+ info



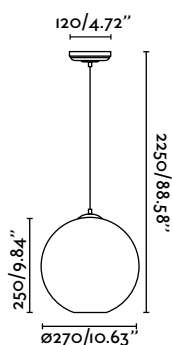


ALMA [new]

Pendant Lamp

Ref.	64127	transparent transparente
Bulb	1xE27 100W not incl. [10310]	
Materials	Metal + Glass Metal + Cristal	
V/Hz	100-240V / 50-60 Hz	
EEL	A++ to E	
Weight	1.04 kg / 2.29 lb	

+ info



CLARA [new]

Pendant Lamp

Ref.	64128	transparent transparente
Bulb	1xE27 100W not incl. [10310]	
Materials	Metal + Glass Metal + Cristal	
V/Hz	100-240V / 50-60 Hz	
EEL	A++ to E	
Weight	1.04 kg / 2.29 lb	

+ info







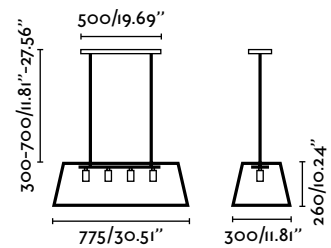
ROSE [new]

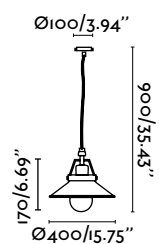
**Pendant
Lamp**

**TELESCOPIC
TELESCOPICO**

Ref.	65081	 	black+transparent negro+transparente
Bulb	4xE27 60W not incl. [LED 17429]		
Materials	Metal + Transparent Glass Metal + Cristal Transparente		
V/Hz	100-240V / 50-60 Hz		
EEL	A++ to E		
Weight	7.63 kg / 16.82 lb		

+ info 





TAVERN

Pendant Lamp

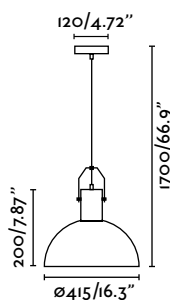
Ref.	68144 off white blanco roto
Bulb	1xE27 max 60W not incl. [LED 17458]
Materials	Metal Metal
V/Hz	100-240V / 50-60 Hz
EEl	A++ to E
Weight	1.6 kg / 3.53 lb

+ info



MARGOT

Pendant Lamp



Ref.	68561 black negro
Bulb	1xE27 max 25W not incl. [LED 17458]
Materials	Metal + Wood Metal + Madera
V/Hz	100-240V / 50-60 Hz
EEl	A++ to E
Weight	2.13 kg / 4.70 lb

+ info







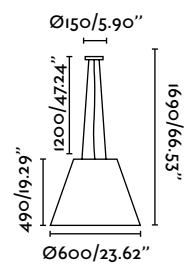
PÉRGAMO

**Pendant
Lamp**


By Faro Team

Ref.	29300	  beige+black beige+negro
Bulb	3xE27 max 60W not incl. [LED 17453]	
Materials	Steel + Acrylic + Parchment Acero + Acrílico + Pergamino	
V/Hz	100-240V / 50-60 Hz	
EEL	A++ to E	
Weight	1.33 kg / 2.93 lb	

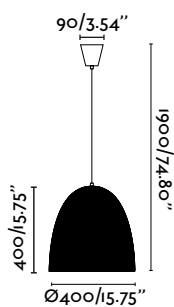
+ info




LIANA [new]**Pendant
Lamp**

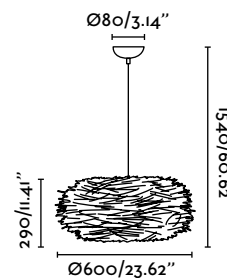
Ref.	68569  wood brown marrón madera
Bulb	1xE27 60W not incl. [LED 17458]
Materials	Metal + Hemp Metal + C�a�amo
V/Hz	100-240V / 50-60 Hz
EEL	A++ to E
Weight	1.97 kg / 4.34 lb

+ info

**NIDO****Pendant
Lamp**

Ref.	68153  orange brown marr�n anaranjado
Bulb	1xE27 max 60W not incl. [LED 17458]
Materials	Steel + Rattan Acero + Rattan
V/Hz	100-240V / 50-60 Hz
EEL	A++ to E
Weight	3.41 kg / 7.52 lb

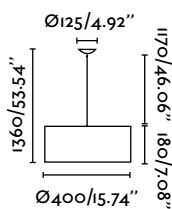
+ info






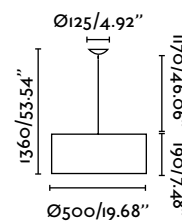
SEVEN

Pendant Lamp-p






Ref.	68283  white blanco
Bulb	2xE27 max 60W not incl. [LED 17453]
Materials	Metal + Textile + PVC Metal + T�xtil + PVC
V/Hz	100-240V / 50-60 Hz
EEL	A++ to E
Weight	2.1 kg / 4.63 lb

+ info  



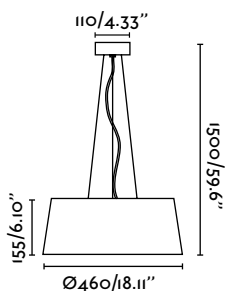
SEVEN

Pendant Lamp-g

Ref.	68284  white blanco
	68285  bordeaux burdeos
	68286  chocolate brown marr�n chocolate
Bulb	3xE27 max 60W not incl. [LED 17453]
Materials	Metal + Textile + PVC Metal + T�xtil + PVC
V/Hz	100-240V / 50-60 Hz
EEL	A++ to E
Weight	2.1 kg / 4.63 lb

+ info  






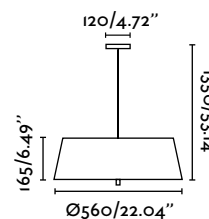
AINA [new]

Pendant Lamp

LED



Ref.	64174	 white blanco
Bulb	SMD LED 40W 2700K 3000Lm CRI>80 incl.	
Materials	Aluminium + Textile + Opal Polycarbonate Aluminio + T�xtil + Policarbonato Opal	
V/Hz	220-240V / 50-60 Hz	
EEL	A++ to A	
Weight	2.18 kg / 4.81 lb	

+ info   



PROSA

Pendant Lamp

Ref.	68535	  matt nickel+white n�quel mate+blanco
Bulb	3xE27 max 60W not incl. [LED 17453]	
Materials	Metal + Textile + Opal Glass Metal + T�xtil + Cristal Opal	
V/Hz	100-240V / 50-60 Hz	
EEL	A++ to E	
Weight	5.75 kg / 12.68 lb	

+ info  

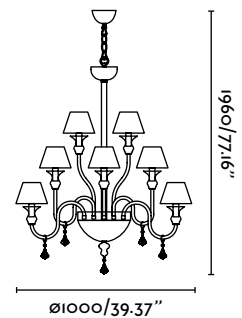


MURANO

Pendant Lamp


Ref.	29293 ● black negro
Bulb	16xE14 max 60W not incl. [LED 17451]
Materials	Metal + Textile + Glass Metal + T�xtil + Cristal
V/Hz	100-240V / 50-60 Hz
EEl	A++ to E
Weight	24.5 kg / 54.01 lb

+ info

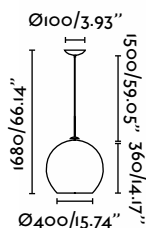


MALI

**Pendant
Lamp-g**


Ref.	66873  white blanco
Bulb	1xE27 max 60W not incl. [LED 17458]
Materials	Metal + PVC Metal + PVC
V/Hz	100-240V / 50-60 Hz
EEL	A++ to E
Weight	1.9 kg / 4.19 lb

+ info

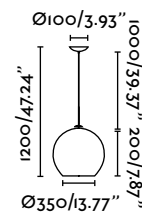


MALI

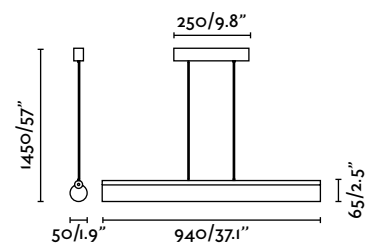
**Pendant
Lamp-p**

Ref.	66872  white blanco
Bulb	1xE27 max 60W not incl. [LED 17458]
Materials	Metal + PVC Metal + PVC
V/Hz	100-240V / 50-60 Hz
EEL	A++ to E
Weight	1.45 kg / 3.20 lb

+ info









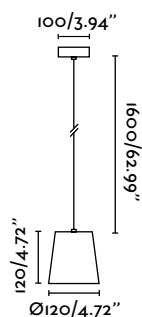
LUCE

Pendant Lamp

LED

Ref.	64176	 	chrome+white cromo+blanco
Bulb	SMD LED 35W 2700K 2400Lm incl.		
Materials	Aluminium + Opal PMMA Aluminio + PMMA Opal		
V/Hz	220-240V / 50-60 Hz		
EEL	A		
Weight	2.9 kg / 6.39 lb		


+ info



MIA

Pendant Lamp

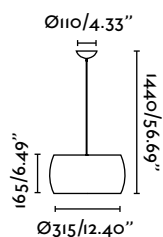
LED

Ref.	64175		white blanco
Bulb	SMD LED 8W 3000K 600Lm incl.		
Materials	Metal + Opal Glass Metal + Cristal Opal		
V/Hz	100-240V / 50-60 Hz		
EEL	A+		
Weight	1.95 kg / 4.30 lb		

+ info







NANKO

Pendant Lamp

Ref.	64139		white blanco
	64145		black negro
Bulb	1xE27 max 60W not incl. [LED 17458]		
Materials	Aluminium + Teflon Aluminio + Teflón		
V/Hz	100-240V / 50-60 Hz		
EEL	A++ to E		
Weight	2.3 kg / 5.07 lb		

+ info



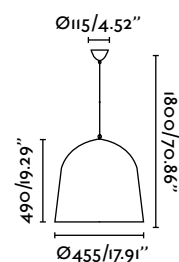
HF

HF



HF

Until stock exhaustion
Hasta final de stock
Jusqu'à la fin de stock



CRÁTER

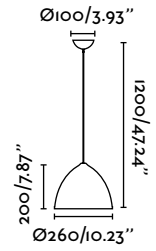
Pendant Lamp

Ref.	68461			black+gold negro+oro
	Bulb 3xE27 max 40W not incl. [LED 17458]			
Materials	Aluminium Aluminio			
V/Hz	100-240V / 50-60 Hz			
EEL	A++ to E			
Weight	4.3 kg / 9.48 lb			

+ info





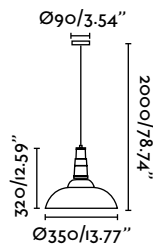


ALDER

Pendant Lamp

Ref.	64140		white blanco
	64141		black negro
	64142		red rojo
Bulb	1xE27 max 60W not incl. [LED 17458]		
Materials	Aluminium Aluminio		
V/Hz	100-240V / 50-60 Hz		
EEL	A++ to E		
Weight	0.7 kg / 1.54 lb		

+ info



BAR

Pendant Lamp

Ref.	64132		white blanco
Bulb	1xE27 max 60W not incl. [LED 17458]		
Materials	Steel Acero		
V/Hz	100-240V / 50-60 Hz		
EEL	A++ to E		
Weight	1.3 kg / 2.87 lb		

+ info

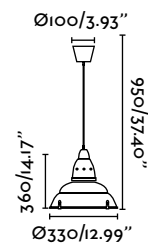







SIRIA

Pendant Lamp

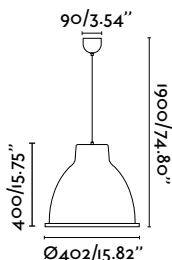




Ref.	64104	 matt nickel níquel mate
Bulb	1xE27 max 60W not incl. [LED 17458]	
Materials	Aluminium + Glass Aluminio + Cristal	
V/Hz	100-240V / 50-60 Hz	
EEL	A++ to E	
Weight	2.4 kg / 5.29 lb	

+ info  

CHARLOTTE [new]

Pendant Lamp



Ref.	68562	 dark grey gris oscuro
	68563	 white blanco
Bulb	1xE27 60W not incl. [LED 17458]	
Materials	Steel + Opal Glass Acero + Cristal Opal	
V/Hz	100-240V / 50-60 Hz	
EEL	A++ to E	
Weight	2.27 kg / 5.00 lb	


+ info  



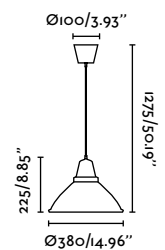


ALUMINIO

Pendant Lamp

Ref.	64100  matt nickel níquel mate
Bulb	1x E27 max 75W not incl. [LED 17458]
Materials	Aluminium Aluminio
V/Hz	100-240V / 50-60 Hz
EEL	A++ to E
Weight	0.68 kg / 1.50 lb


+ info





CILO

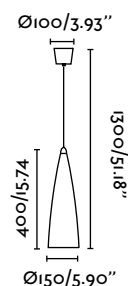
Pendant Lamp

Ref.	64102	 matt nickel níquel mate
Bulb	1xE27 max 60W not incl. [LED 17458]	
Materials	Aluminium Aluminio	
V/Hz	100-240V / 50-60 Hz	
EEL	A++ to E	
Weight	0.48 kg / 1.06 lb	

+ info




HF



PLATILLO

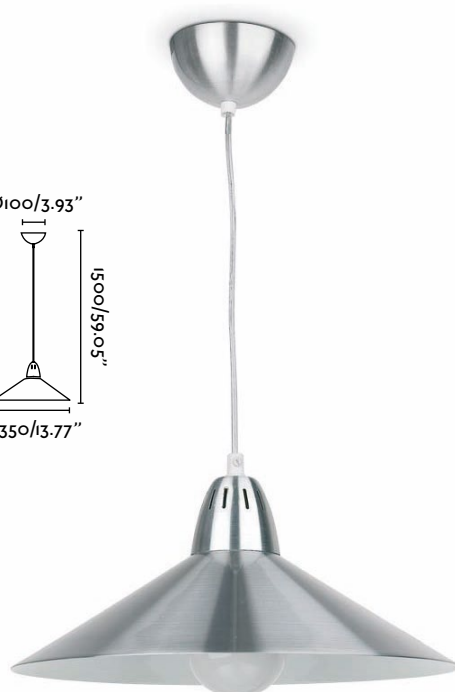
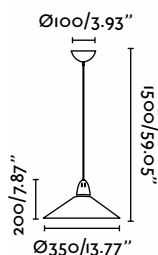
Pendant Lamp

Ref.	64109	 matt nickel níquel mate
Bulb	1xE27 max 60W not incl. [LED 17458]	
Materials	Aluminium Aluminio	
V/Hz	100-240V / 50-60 Hz	
EEL	A++ to E	
Weight	0.54 kg / 1.19 lb	

+ info




HF



ALUMINIO

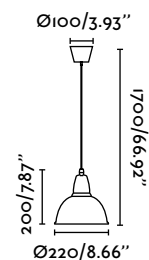
Pendant Lamp

Ref.	64101	 matt nickel níquel mate
Bulb	1xE27 max 75W not incl. [LED 17458]	
Materials	Aluminium Aluminio	
V/Hz	100-240V / 50-60 Hz	
EEL	A++ to E	
Weight	0.42 kg / 0.93 lb	

+ info

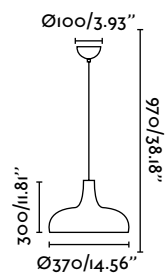


HF




HF Until stock exhaustion
Hasta final de stock
Jusqu'à la fin de stock





BONGO

Pendant Lamp


Ref.	64108	 matt nickel níquel mate
Bulb	1xE27 max 60W not incl. [LED 17458]	
Materials	Aluminium Aluminio	
V/Hz	100-240V / 50-60 Hz	
EEL	A++ to E	
Weight	1.6 kg / 3.53 lb	

+ info

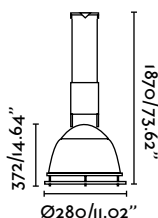


NITRO

Pendant Lamp

Ref.	64125	 matt nickel níquel mate
Bulb	1xE27 max 60W not incl. [LED 17458]	
Materials	Aluminium + Glass Aluminio + Cristal	
V/Hz	100-240V / 50-60 Hz	
EEL	A++ to E	
Weight	3.3 kg / 7.28 lb	

+ info

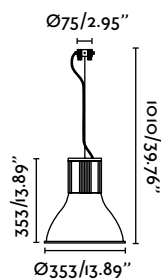



HF



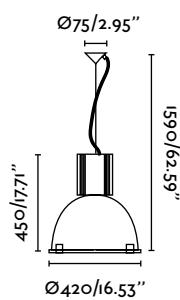
HF Until stock exhaustion
Hasta final de stock
Jusqu'à la fin de stock




**TRANSFER****Pendant Lamp**

Ref.	64131	 matt nickel níquel mate
Bulb	3xE27 max 60W not incl. [LED 17453]	
Materials	Die Cast Aluminium + PMMA Aluminio Inyectado + PMMA	
V/Hz	100-240V / 50-60 Hz	
EEL	A++ to E	
Weight	3 kg / 6.61 lb	

+ info

**ÓLEO****Pendant Lamp**

Ref.	64129	 matt nickel níquel mate
Bulb	1xE27 max 100W not incl. [LED 17200]	
Materials	Aluminium + Glass Aluminio + Cristal	
V/Hz	100-240V / 50-60 Hz	
EEL	A++ to E	
Weight	5.1 kg / 11.24 lb	

+ info



More suspended



Conik
17



Hotel
47



Lara
94



Linda
61



Fusta
35



Link
65



Lise
77



Lupe
33



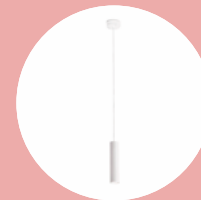
Mitic
93



Mix
56



Nudos
101



Ora
79



Plec
69



Retro
19



Saba
97



Sweet
51



Thana
89



Tree
53



Vesper
43



Volta
38



Winch
72

Álamo	188
Cup	180
Galaxia	184
Lune	193
Mika	186
Ring	182
Star	193

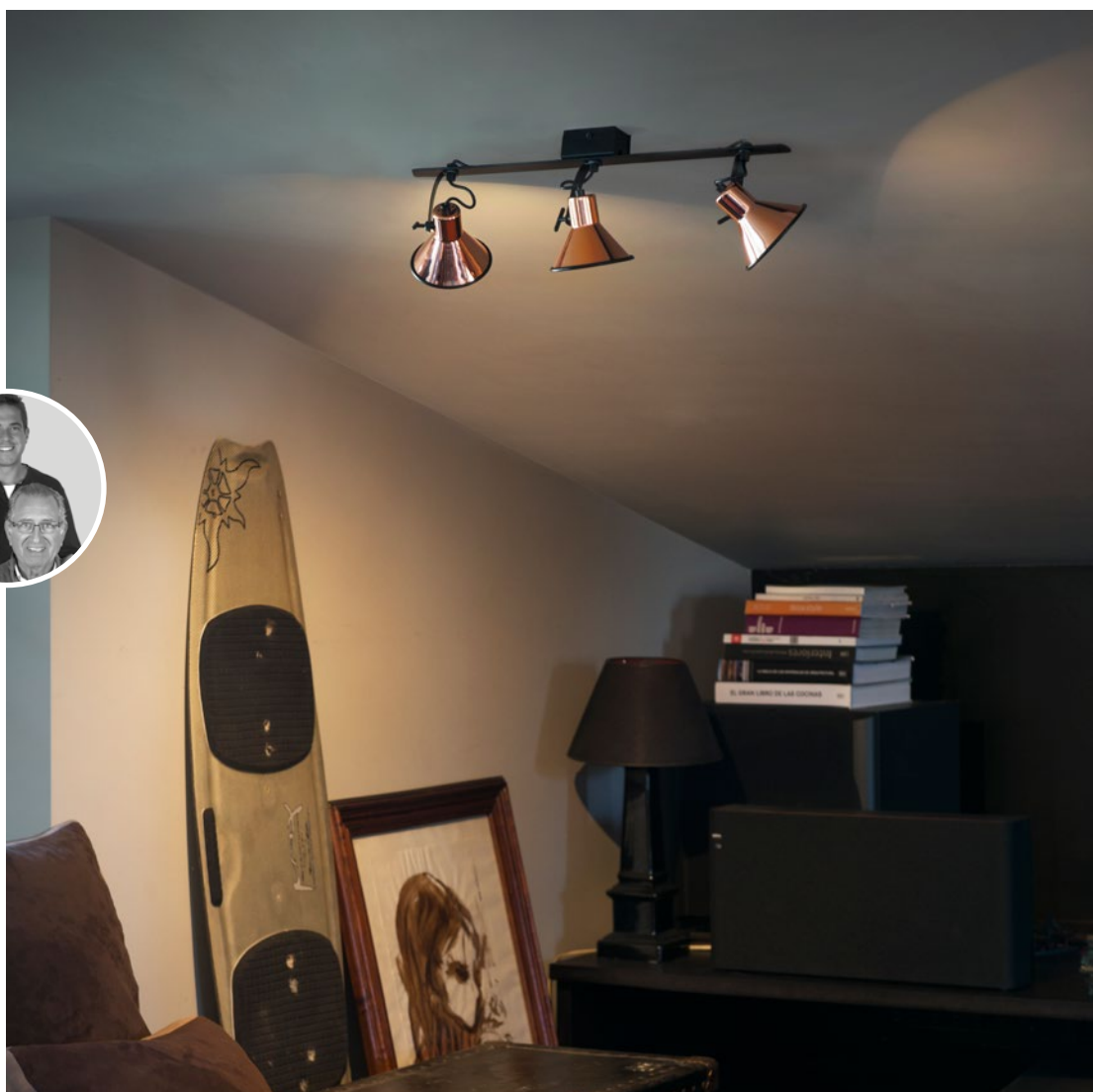
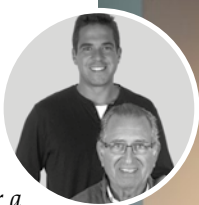


spot
lights

Cup [new]




Design: Àlex&Manel
Llusçà

New finishes
and textures for a
modern serie consisting
of a spotlight, wall lamps
and a ceilings lamp.



[new]

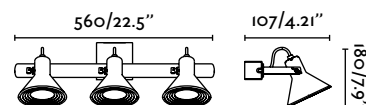
**Wall
Lamp**

Ref.	40586		copper cobre
	40587		matt nickel níquel mate
	40588		white blanco
Bulb	3xGU10 LED max 8W not incl. [LED I7324]		
Materials	Metal Metal		
V/Hz	100-240V / 50-60 Hz		
EEL	A++ to B		
Weight	1.29 kg / 2.84 lb		

+ info






Only with LED / Uso exclusivo LED



[new]

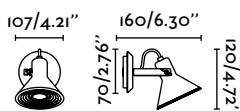
Spotlight

Ref.	40580		copper cobre
	40581		matt nickel níquel mate
	40582		white blanco
Bulb	1xGU10 LED max 8W not incl. [LED 17324]		
Materials	Metal Metal		
V/Hz	100-240V / 50-60 Hz		
EEL	A++ to B		
Weight	0.35 kg / 0.77 lb		

+ info






Only with LED / Uso exclusivo LED



[new]

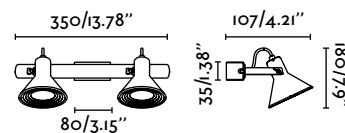
Wall Lamp

Ref.	40583		copper cobre
	40584		matt nickel níquel mate
	40585		white blanco
Bulb	2xGU10 LED max 8W not incl. [LED 17324]		
Materials	Metal Metal		
V/Hz	100-240V / 50-60 Hz		
EEL	A++ to B		
Weight	0.88 kg / 1.94 lb		

+ info






Only with LED / Uso exclusivo LED



[new]

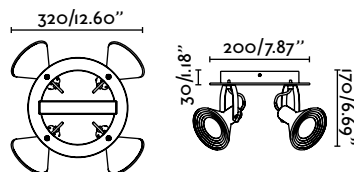
Ceiling Lamp

Ref.	40589		copper cobre
	40590		matt nickel níquel mate
	40591		white blanco
Bulb	4xGU10 LED max 8W not incl. [LED 17324]		
Materials	Metal Metal		
V/Hz	100-240V / 50-60 Hz		
EEL	A++ to B		
Weight	1.35 kg / 2.98 lb		

+ info



Only with LED / Uso exclusivo LED



Ring




Design: Àlex&Manel
Llusçà



Spotlights
line with a classical
multi-jointed mixture
of colours with chrome,
giving the collection a
certain retro car style.



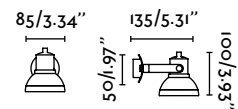
Spotlight

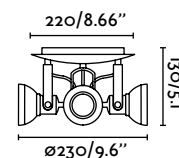
Ref.	40550		white blanco
	40551		dark grey gris oscuro
	40552		matt nickel níquel mate
Bulb	1xGU10 LED max 8W not incl. [LED 17324]		
Materials	Metal Metal		
V/Hz	100-240V / 50-60 Hz		
EEL	A++ to B		
Weight	0.35 kg / 0.77 lb		

+ info



Only with LED / Uso exclusivo LED



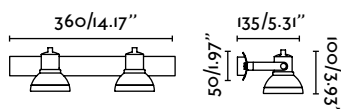


Ceiling Lamp

Ref.	40559		white blanco
	40560		dark grey gris oscuro
	40561		matt nickel níquel mate
Bulb	4xGU10 LED max 8W not incl. [LED 17324]		
Materials	Metal Metal		
V/Hz	100-240V / 50-60 Hz		
EEL	A++ to B		
Weight	1.43 kg / 3.15 lb		

+ info

Only with LED / Uso exclusivo LED



Wall Lamp

Ref.	40553		white blanco
	40554		dark grey gris oscuro
	40555		matt nickel níquel mate
Bulb	2xGU10 LED max 8W not incl. [LED 17324]		
Materials	Metal Metal		
V/Hz	100-240V / 50-60 Hz		
EEL	A++ to B		
Weight	0.95 kg / 2.09 lb		

+ info

Only with LED / Uso exclusivo LED

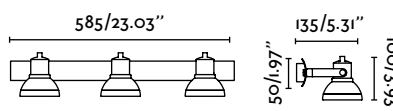


Wall Lamp

Ref.	40556		white blanco
	40557		dark grey gris oscuro
	40558		matt nickel níquel mate
Bulb	3xGU10 LED max 8W not incl. [LED 17324]		
Materials	Metal Metal		
V/Hz	100-240V / 50-60 Hz		
EEL	A++ to B		
Weight	1.45 kg / 3.20 lb		

+ info

Only with LED / Uso exclusivo LED






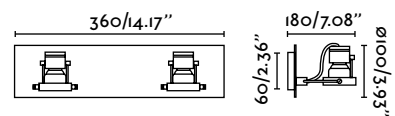
GALAXIA

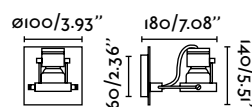
Wall
Lamp


BULB INCLUDED
BOMBILLA INCLUIDA

Ref.	40792	 matt nickel níquel mate
Bulb	2xGU10 max 50W incl. [LED 17316]	
Materials	Metal Metal	
V/Hz	220-240V / 50-60 Hz	
EEL	A++ to D	
Weight	1.3 kg / 2.87 lb	

+ info 




**GALAXIA****Spotlight****BULB INCLUDED**
BOMBILLA INCLUIDA

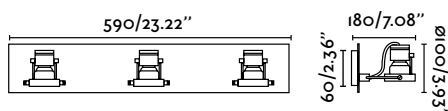
Ref.	40791	 matt nickel níquel mate
Bulb	1xGU10 max 50W incl. [LED 17316]	
Materials	Metal Metal	
V/Hz	220-240V / 50-60 Hz	
EEL	A++ to D	
Weight	0.6 kg / 1.32 lb	


+ info

**GALAXIA****Wall Lamp****BULB INCLUDED**
BOMBILLA INCLUIDA

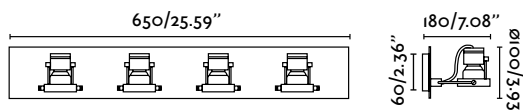
Ref.	40793	 matt nickel níquel mate
Bulb	3xGU10 max 50W incl. [LED 17316]	
Materials	Metal Metal	
V/Hz	220-240V / 50-60 Hz	
EEL	A++ to D	
Weight	2.1 kg / 4.63 lb	

+ info

**GALAXIA****Wall Lamp****BULB INCLUDED**
BOMBILLA INCLUIDA

Ref.	40794	 matt nickel níquel mate
Bulb	4xGU10 max 50W incl. [LED 17316]	
Materials	Metal Metal	
V/Hz	220-240V / 50-60 Hz	
EEL	A++ to D	
Weight	2.49 kg / 5.49 lb	



+ info



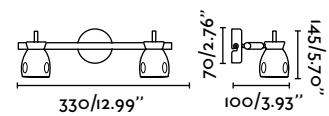


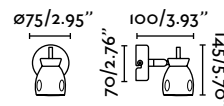
MIKA

Wall Lamp

Ref.	40881		chrome+white cromo+blanco
	40885		chrome+black cromo+negro
Bulb	2xGU10 max 50W not incl. [LED 17316 white/LED 17324 black]		
Materials	Steel Acero		
V/Hz	100-240V / 50-60 Hz		
EEL	A++ to E		
Weight	0.59 kg / 1.30 lb		

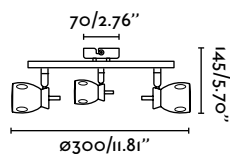
+ info 



**MIKA****Spotlight**

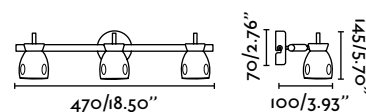
Ref.	40880			chrome+white cromo+blanco
	40884			chrome+black cromo+negro
Bulb	1xGU10 max 50W not incl. [LED 17316 white/LED 17324 black]			
Materials	Steel Acero			
V/Hz	100-240V / 50-60 Hz			
EEL	A++ to E			
Weight	0.27 kg / 0.60 lb			

+ info

**MIKA****Ceiling Lamp**

Ref.	40883			chrome+white cromo+blanco
	40887			chrome+black cromo+negro
Bulb	3xGU10 max 50W not incl. [LED 17316 white/LED 17324 black]			
Materials	Steel Acero			
V/Hz	100-240V / 50-60 Hz			
EEL	A++ to E			
Weight	1.12 kg / 2.47 lb			

+ info

**MIKA****Wall Lamp**

Ref.	40882			chrome+white cromo+blanco
	40886			chrome+black cromo+negro
Bulb	3xGU10 max 50W not incl. [LED 17316 white/LED 17324 black]			
Materials	Steel Acero			
V/Hz	100-240V / 50-60 Hz			
EEL	A++ to E			
Weight	0.81 kg / 1.79 lb			

+ info







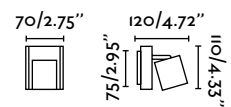
ÁLAMO

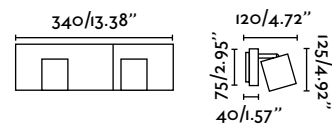
BULB INCLUDED
BOMBILLA INCLUIDA

Spotlight

Ref.	40938	 	wenge+chrome wengué+cromo
Bulb	1xG9 40W incl. [LED 17443]		
Materials	Wood + Metal + Translucent Glass Madera + Metal + Cristal Translúcido		
V/Hz	220-240V / 50-60 Hz		
EEL	A to D		
Weight	0.82 kg / 1.81 lb		

+ info





ÁLAMO

Wall
Lamp

BULB INCLUDED
BOMBILLA INCLUIDA

Ref. **40939** ● ● wenge+chrome
wengué+cromo

Bulb 2xG9 40W incl. [LED 17443]

Materials Wood + Metal + Translucent Glass
Madera + Metal + Cristal Translúcido

V/Hz 220-240V / 50-60 Hz

EEL A to D

Weight 1.8 kg / 3.97 lb

+ info 



ÁLAMO

Wall
Lamp

BULB INCLUDED
BOMBILLA INCLUIDA

Ref. **40940** ● ● wenge+chrome
wengué+cromo

Bulb 3xG9 40W incl. [LED 17443]

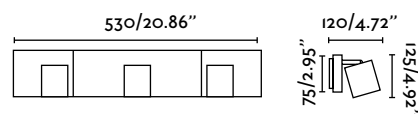
Materials Wood + Metal + Translucent Glass
Madera + Metal + Cristal Translúcido

V/Hz 220-240V / 50-60 Hz

EEL A to D

Weight 2.77 kg / 6.11 lb

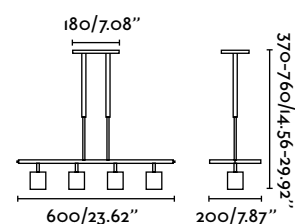
+ info 



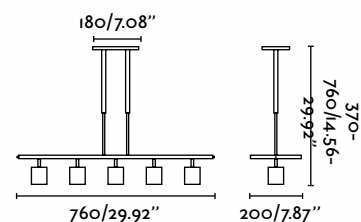
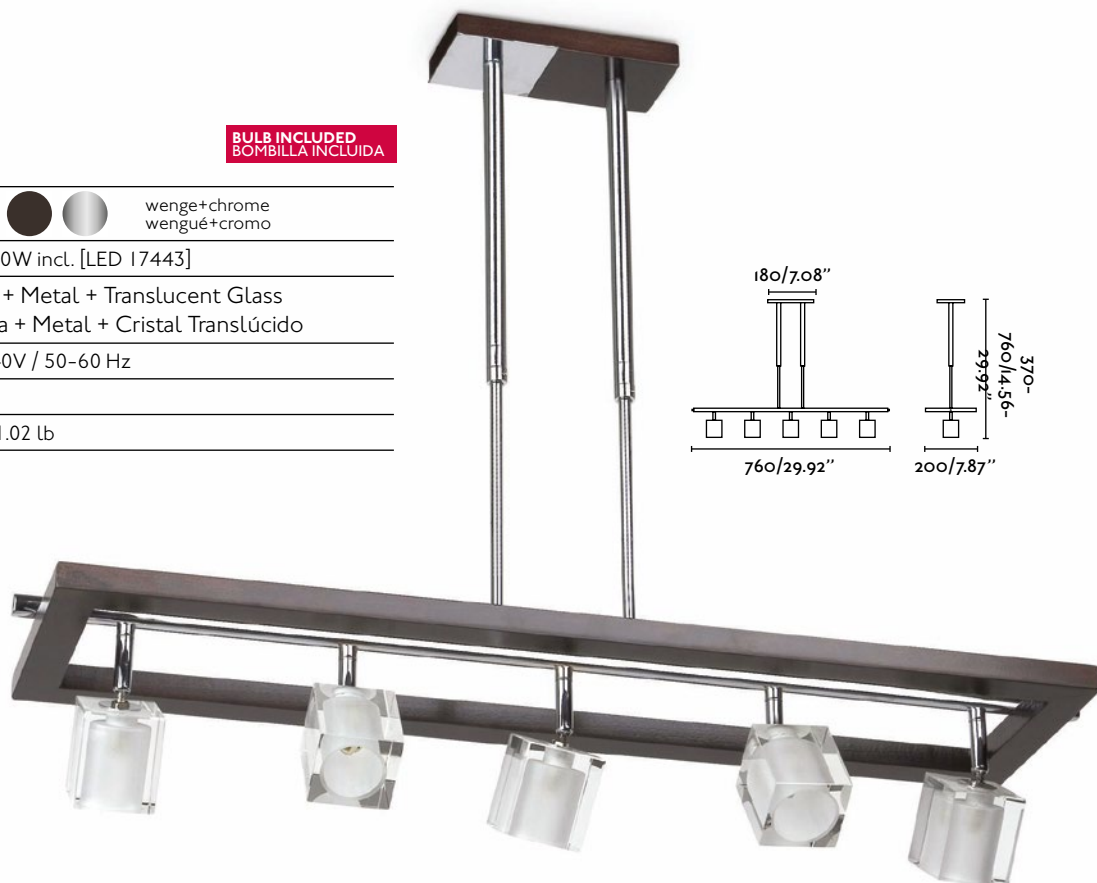


**ÁLAMO****Pendant Lamp****BULB INCLUDED**
BOMBILLA INCLUIDARef. **40941**  wenge+chrome
wengué+cromo**Bulb** 4xG9 40W incl. [LED 17443]**Materials** Wood + Metal + Translucent Glass
Madera + Metal + Cristal Translúcido**V/Hz** 220-240V / 50-60 Hz**EEL** A to D**Weight** 4.1 kg / 9.04 lb

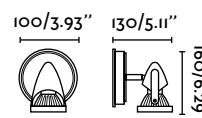
+ info


**ÁLAMO****Pendant Lamp****BULB INCLUDED**
BOMBILLA INCLUIDARef. **40942**  wenge+chrome
wengué+cromo**Bulb** 5xG9 40W incl. [LED 17443]**Materials** Wood + Metal + Translucent Glass
Madera + Metal + Cristal Translúcido**V/Hz** 220-240V / 50-60 Hz**EEL** A to D**Weight** 5 kg / 11.02 lb

+ info

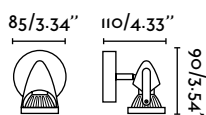







**STAR****Spotlight****BULB INCLUDED**
BOMBILLA INCLUIDA

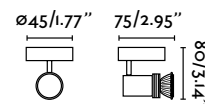
Ref.	40871		wood+rust brown madera+marrón óxido
Bulb	1xGU10 max 50W incl.		
Materials	Metal + Wood Metal + Madera		
V/Hz	220-240V / 50-60 Hz		
EEL	A to D		
Weight	0.36 kg / 0.79 lb		


+ info

**STAR****Spotlight****BULB INCLUDED**
BOMBILLA INCLUIDA

Ref.	40391		matt nickel níquel mate
	40411		old gold oro envejecido
	40891		rust brown marrón óxido
Bulb	1xGU10 max 50W incl.		
Materials	Metal Metal		
V/Hz	220-240V / 50-60 Hz		
EEL	A to D		
Weight	0.3 kg / 0.66 lb		

+ info

**LUNE****Spotlight****BULB INCLUDED**
BOMBILLA INCLUIDA

Ref.	40421		matt nickel níquel mate
Bulb	1xGU10 max 50W incl.		
Materials	Metal Metal		
V/Hz	220-240V / 50-60 Hz		
EEL	A to D		
Weight	0.3 kg / 0.66 lb		

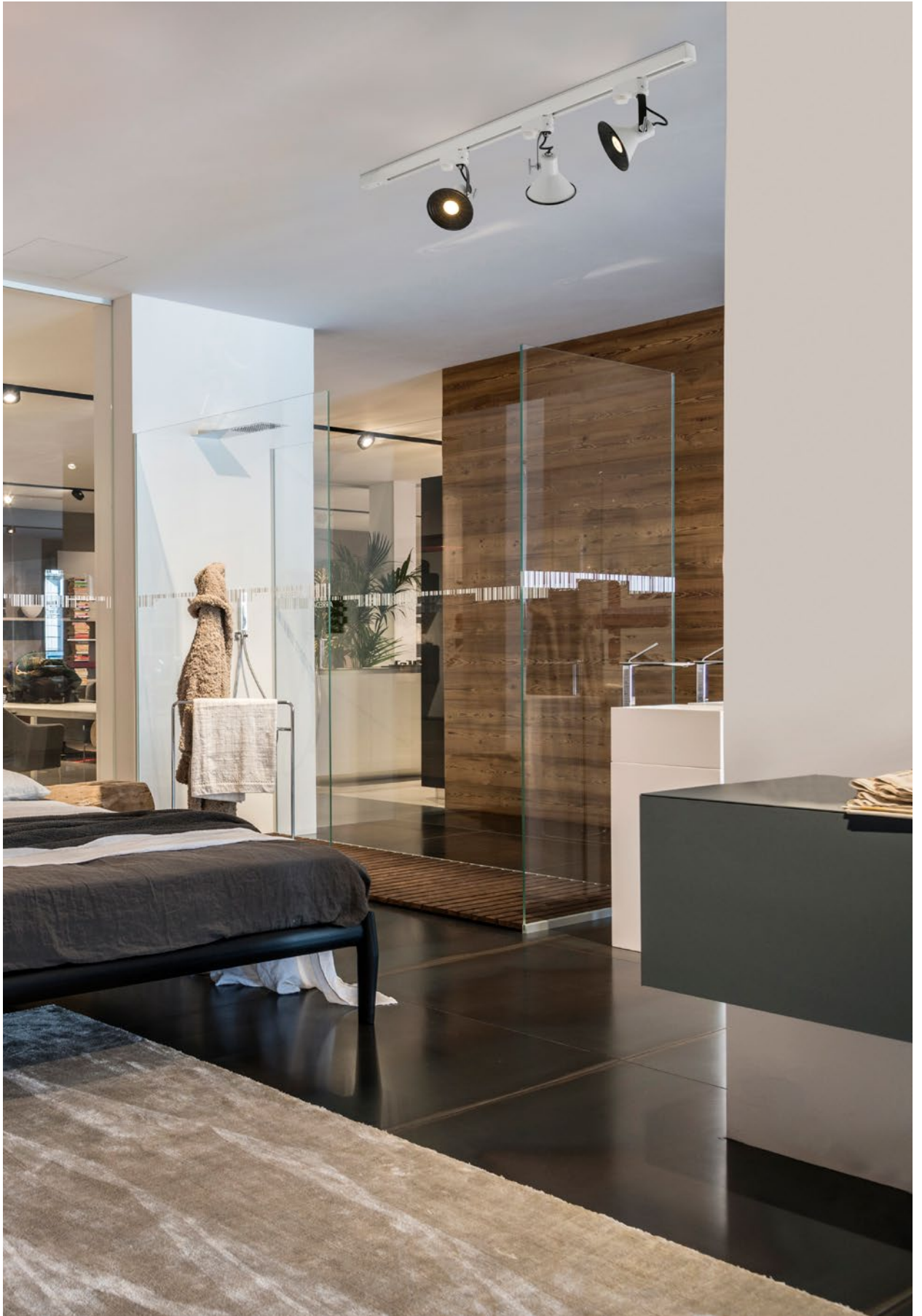
+ info



Cup	197
Link	199
Nan	201
Plot	201
Ram	199
Ring	197






track
projectors



CUP [new]

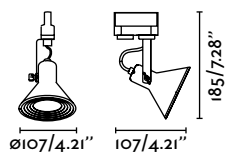
Track Projector

By Àlex&Manel Llusçà

Ref.	40592		copper cobre
	40593		matt nickel níquel mate
	40594		white blanco
Bulb	1xGU10 LED max 8W not incl. [LED 17324]		
Materials	Metal Metal		
V/Hz	100-240V / 50-60 Hz		
EEL	A++ to B		
Weight	0.34 kg / 0.75 lb		

+ info  




Only with LED / Uso exclusivo LED



RING

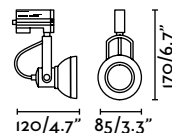
Track Projector

By Àlex&Manel Llusçà

Ref.	40562		white blanco
	40563		dark grey gris oscuro
	40564		matt nickel níquel mate
Bulb	1xGU10 LED max 8W not incl. [LED 17324]		
Materials	Metal Metal		
V/Hz	100-240V / 50-60 Hz		
EEL	A++ to B		
Weight	0.29 kg / 0.64 lb		

+ info  

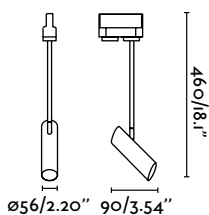
Only with LED / Uso exclusivo LED







LINK [new]

Track Projector

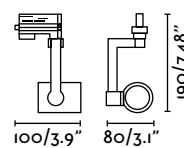




Ref.	29871		white blanco
	29872		black negro
Bulb	1xGU10 max 11W not incl. [LED 17316]		
Materials	Steel Acero		
V/Hz	100-240V / 50-60 Hz		
EEL	A++ to B		
Weight	0.8 kg / 1.76 lb		

+ info



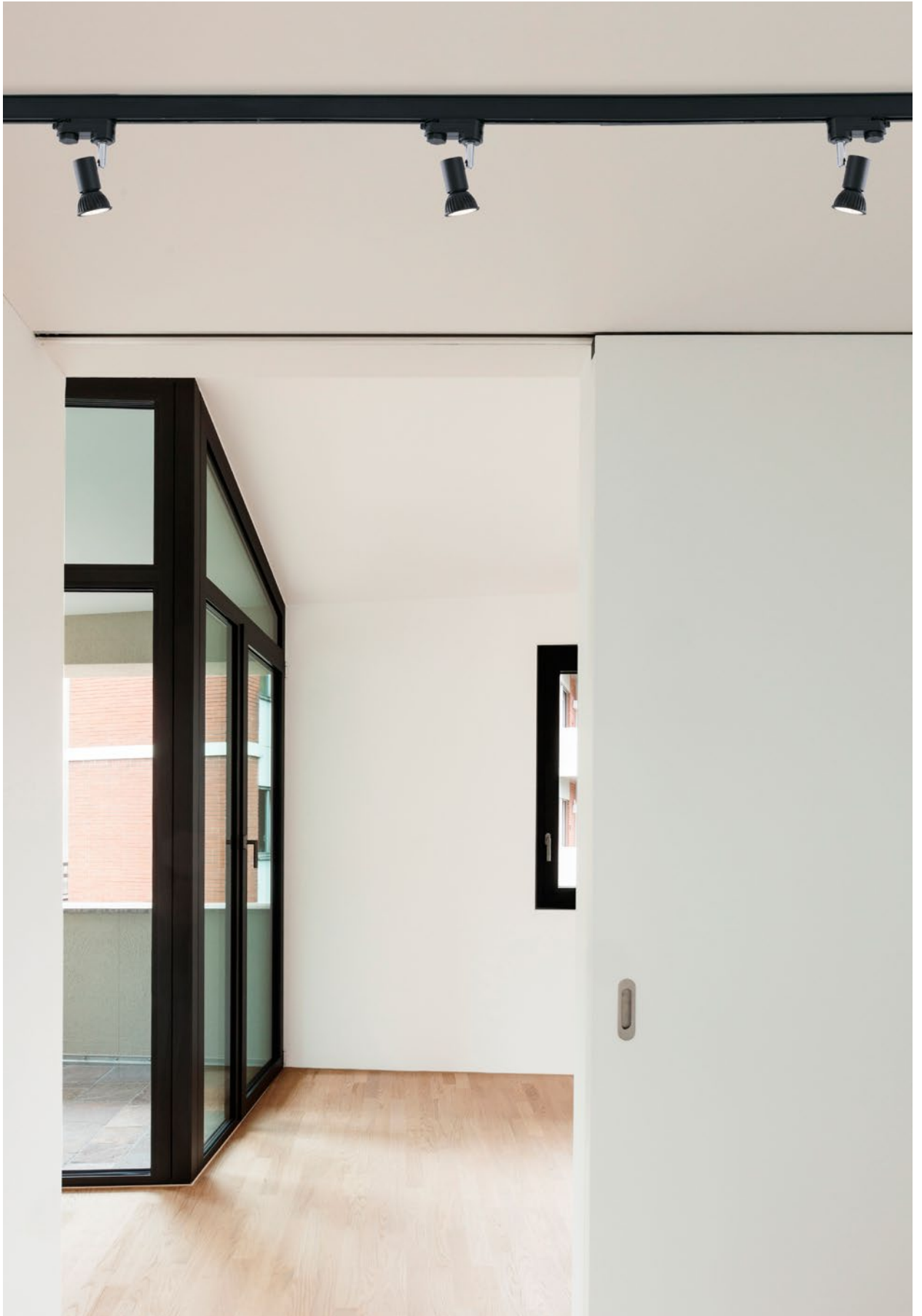
RAM
Track Projector



Ref.	40100		white blanco
	40101		black negro
Bulb	1xE27 max 80W not incl. [LED 17403]		
Materials	Die Cast Aluminium Aluminio Inyectado		
V/Hz	100-240V / 50-60 Hz		
EEL	A++ to E		
Weight	0.3 kg / 0.66 lb		

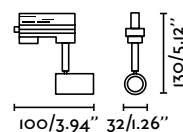
+ info










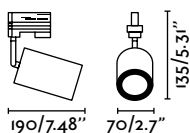
PLOT
Track Projector






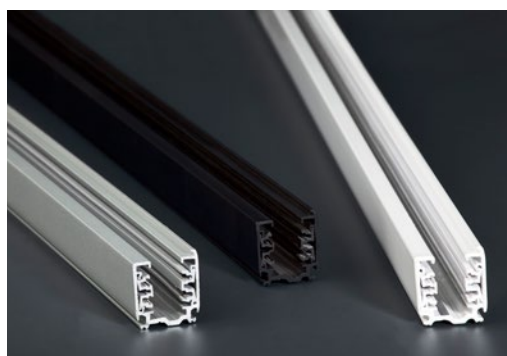
Ref.	64202		white blanco
	64203		black negro
Bulb	1xGU10 50W not incl. [LED 17324]		
Materials	Metal Metal		
V/Hz	100-240V / 50-60 Hz		
EEl	A++ to E		
Weight	0.14 kg / 0.31 lb		
+ info			

NAN [new]

Track Projector



Ref.	64192		white blanco
	64193		black negro
Bulb	1xGU10 max 50W not incl. [LED 17324]		
Materials	Aluminium Aluminio		
V/Hz	100-240V / 50-60 Hz		
EEl	A++ to E		
Weight	0.4 kg / 0.88 lb		
+ info			



Surface Track Kit 1M
Kit Carril Superficie 1M

64210		white blanco
64212		black negro
64214		grey gris



Surface Track Kit 2M
Kit Carril Superficie 2M

64211		white blanco
64213		black negro
64215		grey gris



✓ Surface track
Carril superficie

✓ End cap without power
Cabezal de cierre

✓ Main supply
Cabezal de alimentación

✓ Surface ceiling kit
Kit de superficie

Ambo	246	Homs	235	Portos	251
Ángulo	249	Ibiscus	249	Ray	220
Art	233	Ikon	259	Relax	269
Aurea	214	Indo	271	Roda	225
Bird	228	Juliet	221	Room	208
Calda	263	Klimt	255	Sabana	210
Celia	219	Lampetta	216	Sami	221
Cheras	242	Laos	265	Sinki	225
Code	230	Lass	270	Sintra	251
Cono	245	Liria	248	Siret	261
Dallas	235	Loke	222	Snow	239
Data	250	Lumiere	257	Stella	225
Degas	255	Marlin	233	Suau	206
Diula	252	Mild	259	Sunny	253
Doka	267	Monet	257	Swing	212
Eaco	241	Niger	269	Terma	263
Elsa	237	Ola	252	Tub	221
Gina	235	Olaf	237	Twin	245
Groe	239	Oslo	239	Vera	249
Handy	204	Ovo	226		
Henlein	257	Petra	219		



Handy [new]

Design: Jordi Blasi




Handy is functional. A lamp that fades into a practical shelf designed to place a book or to recharge a mobile phone using its USB device.

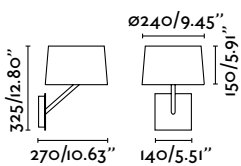


[new]

Wall Lamp

Ref.	28413	 white blanco
Bulb	1xE27 max 20W not incl. [LED 17453]	
Materials	Steel + Textile Acero + T�xtil	
V/Hz	100-240V / 50-60 Hz	
EEL	A++ to B	
Weight	0.9 kg / 1.98 lb	

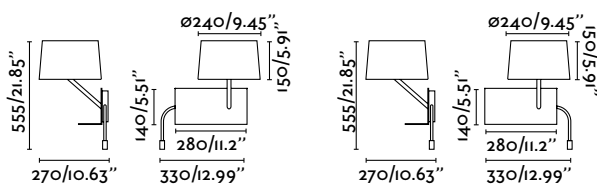
+ info



REF. 28414



REF. 28415





REF. 28414

REF. 28415

[new]

Wall Lamp

Ref.	28414	 white blanco
	28415	 white blanco
Bulb	1xE27 max 20W incl. [LED 17453] + HIGH POWER LED 3W 3000K 140Lm incl.	
Materials	Steel + Textile Acero + T�xtil	
V/Hz	100-240V / 50-60 Hz	
EEL	A++ to A	
Weight	2.1 kg / 4.63 lb	

+ info



Suau [new]

Design: Nahtrang



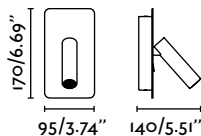
Sensitivity and technology converge in a new way of understanding reader lamps, taking advantage of technological resources like the use of a USB charger.





[new]

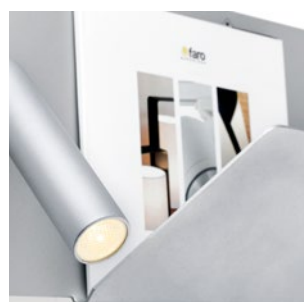
Wall Lamp + Reader

LED



Ref.	62120		matt white blanco mate
	62121		silver plata
Bulb	HIGH POWER LED 3W 3000K 140Lm incl.		
Materials	Steel + Aluminium Acero + Aluminio		
V/Hz	100-240V / 50-60 Hz		
EEL	A++ to A		
Weight	0.63 kg / 1.39 lb		





+ info   



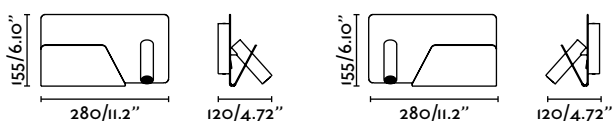
[new]

Wall Lamp

LED

Ref.	62122		matt white blanco mate
	62123		silver plata
	62124		matt white blanco mate
	62125		silver plata
Bulb	HIGH POWER LED 3W 3000K 140Lm incl.		
Materials	Steel + Aluminium Acero + Aluminio		
V/Hz	100-240V / 50-60 Hz		
EEL	A++ to A		
Weight	1.58 kg / 3.48 lb		

+ info    



REFS. 62124 / 62125

REFS. 62122 / 62123

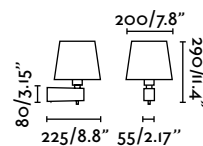
Room

Design: Àlex&Manel
Llusçà







Elegant and
timeless design.
The same wall light
with renewed lines.
Version with LED
reader for added comfort
in bedrooms or living
rooms.





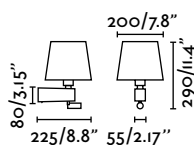
Wall Lamp





Ref.	29974			matt nickel+white níquel mate+blanco
	29975			matt nickel+black níquel mate+negro

Bulb	1xE27 20W not incl. [LED 17453]
Materials	Metal + Textile Metal + Tèxtil
V/Hz	100-240V / 50-60 Hz
EEl	A++ to E
Weight	0.84 kg / 1.85 lb



Wall Lamp + Reader



Ref.	29976			matt nickel+white níquel mate+blanco
	29977			matt nickel+black níquel mate+negro

Bulb	1xE27 20W not incl. [LED 17453] + HIGH POWER LED 3W 3000K incl.
Materials	Metal + Textile Metal + Tèxtil
V/Hz	100-240V / 50-60 Hz
EEl	A++ to E
Weight	0.91 kg / 2.01 lb

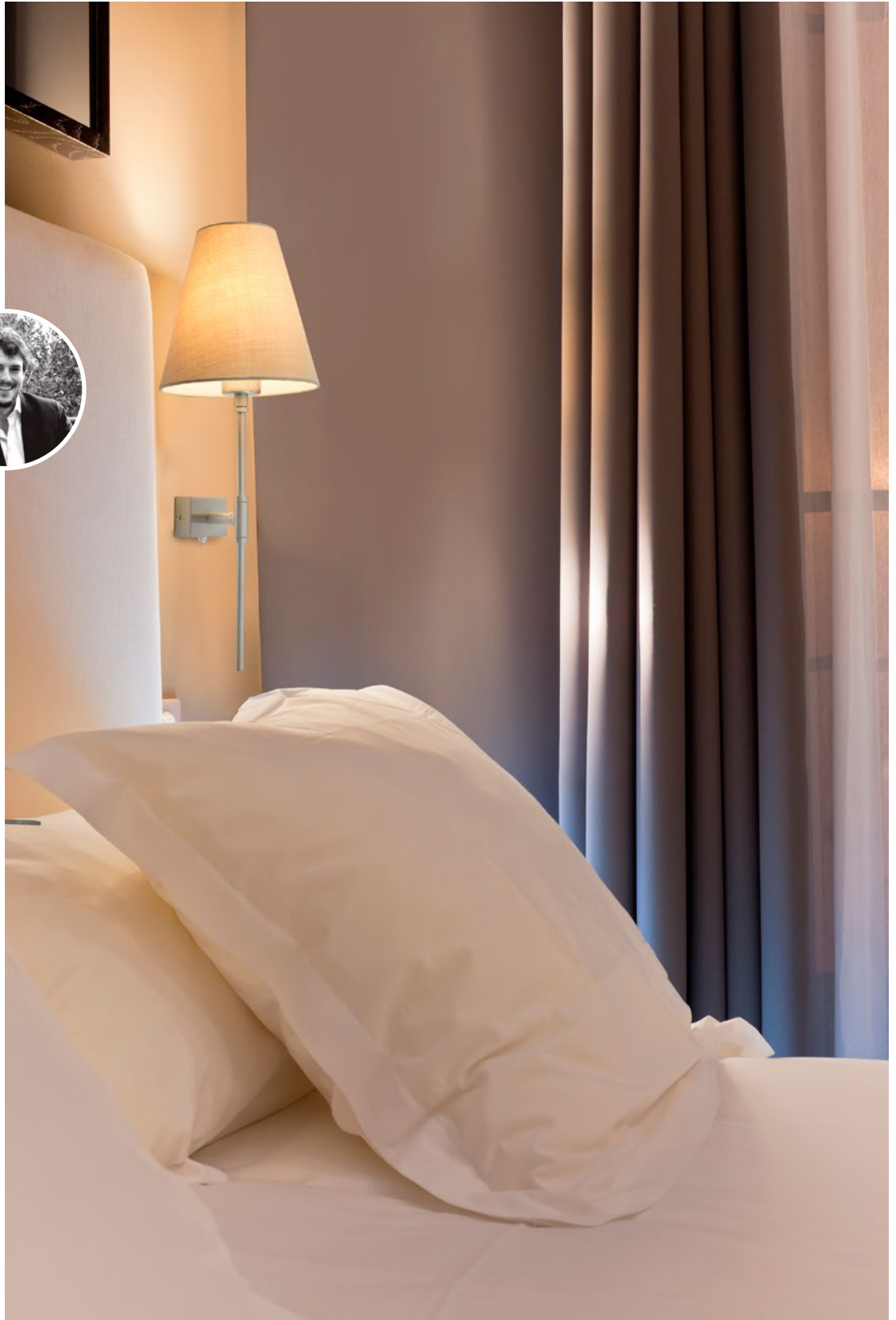


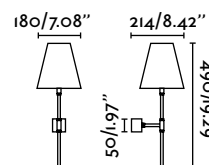
Sabana

Design: Pepe Llaudet





Based on true african lodge style, the metal arm is characterized by the angular delivery of a vertical line and a horizontal functional support.

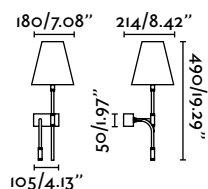








Wall Lamp

Ref.	29993	 	matt nickel+beige níquel mate+beige
Bulb	1xE27 max 15W not incl. [LED 17452]		
Materials	Steel + Textile Acero + T��xtil		
V/Hz	100-240V / 50-60 Hz		
EEL	A++ to B		
Weight	1.25 kg / 2.76 lb		

+ info   



Wall Lamp + Reader

Ref.	29991	 	matt nickel+beige níquel mate+beige
	29992	 	matt nickel+beige níquel mate+beige
Bulb	1xE27 max 15W not incl. [LED 17452] + HIGH POWER LED 1W 4000K incl.		
Materials	Steel + Textile Acero + T��xtil		
V/Hz	100-240V / 50-60 Hz		
EEL	A++ to B		
Weight	0.67 kg / 1.48 lb		

+ info    



REF. 29992



REF. 29991

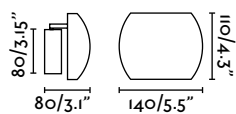
Swing

Design: Àlex&Manel
Llusçà





Versatile and practical surface luminaire. It has a double functionality: wall light and bed reader. Its rounded and clean lines, that hide its mechanical part, stand out.





Wall Lamp

LED ORIENTABLE

Ref.	62112		chrome cromo
	62113		white blanco
Bulb	COB LED 6W 3000K 160LM CRI>80 incl.		
Materials	Metal Metal		
V/Hz	100-240V / 50-60 Hz		
EEL	A++ to A		
Weight	0.62 kg / 1.37 lb		

+ info    

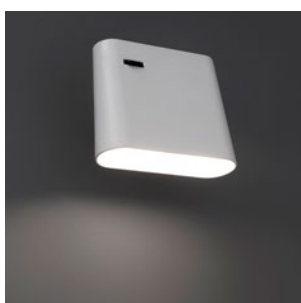
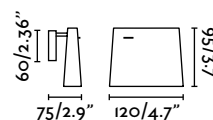
Aurea


Design: Estudi Ribaudf







Aurea is an analysis of the light, a shadow game that creates shades and gradients that give us new sensations. It is simplicity of the shapes, a timeless design.





Wall Lamp	LED	ORIENTABLE	WITH SWITCH CON INTERRUPTOR
Ref.	62115		white blanco
Bulb	SMD LED 6W 2700K 230LM CRI>80 incl.		
Materials	Steel + Aluminium + Translucent Polycarbonate Acero + Aluminio + Policarbonato Translúcido		
V/Hz	100-240V / 50-60 Hz		
EEL	A		
Weight	0.34 kg / 0.75 lb		

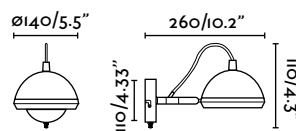
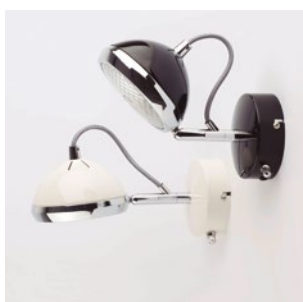
+ info    

Lampetta

Design: Jesper K.
Thomsen

The historical italian motorbike is the object that stimulates Jesper to create his last model.





LAMPETTA

Wall Lamp

DIMMABLE

Ref.	29854	off white blanco roto	HF
	29855	black negro	HF

Bulb 1xGY6.35 max 50W not incl.

Materials Steel + Glass
Acero + Cristal

V/Hz 100-240V / 50-60 Hz

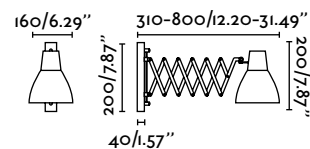
EEL A++ to E

Weight 1.4 kg / 3.09 lb

+ info

HF **Until stock exhaustion**
Hasta final de stock
Jusqu'à la fin de stock





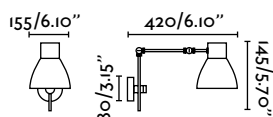
PETRA

Wall Lamp

EXTENSIBLE

Ref.	40062	chrome cromo
Bulb	1xE14 max 40W not incl. [LED 17451]	
Materials	Metal Metal	
V/Hz	100-240V / 50-60 Hz	
EEl	A++ to E	
Weight	0.83 kg / 1.83 lb	

+ info



CELIA

Wall Lamp

WITH PLUG CON ENCHUFE

Ref.	40070	black negro
Bulb	1xE14 max 20W not incl. [LED 17451]	
Materials	Metal + Steel Metal + Acero	
V/Hz	100-240V / 50-60 Hz	
EEl	A++ to B	
Weight	0.73 kg / 1.61 lb	

+ info






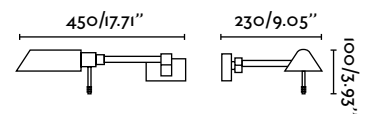
RAY

Wall
Lamp

LED

Ref.	61046	 old gold oro envejecido
Bulb	SMD LED 6W 3000K 600Lm incl.	
Materials	Aluminium + Polycarbonate Aluminio + Policarbonato	
V/Hz	220-240V / 50-60 Hz	
EEL	A++	
Weight	0.8 kg / 1.76 lb	

HF



+ info

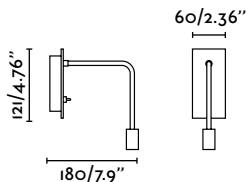


DRIVER 



HF


Until stock exhaustion
Hasta final de stock
Jusqu'à la fin de stock

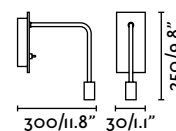


JULIET [new]

Wall Lamp

LED


Ref.	41025	 chrome cromo
Bulb	HIGH POWER LED 3W 3000K 150Lm CRI>80 incl.	
Materials	Metal + Aluminium Metal + Aluminio	
V/Hz	100-240V / 50-60 Hz	
EEL	A+	
Weight	0.4 kg / 0.88 lb	

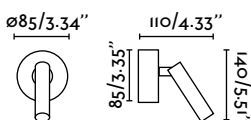


SAMI

Wall Lamp

LED

Ref.	41023	 white blanco
Bulb	HIGH POWER LED 3W 2700K 120Lm CRI>80 incl.	
Materials	Metal Metal	
V/Hz	100-240V / 50-60 Hz	
EEL	A+	
Weight	0.4 kg / 0.88 lb	



TUB

Wall Lamp

LED

Ref.	63231	 silver plata
Bulb	HIGH POWER LED 3W 3000K 140Lm incl.	
Materials	Aluminium + Optical Glass K9 Aluminio + Cristal Óptico K9	
V/Hz	220-240V / 50-60 Hz	
EEL	A++	
Weight	0.5 kg / 1.10 lb	



HF




HF Until stock exhaustion
Hasta final de stock
Jusqu'à la fin de stock



LOKE

LED

Clip

Ref.	40995		chrome cromo
	41021		white blanco
	41022		black negro

Bulb HIGH POWER LED 3W 3000K 120Lm CRI>80 incl.

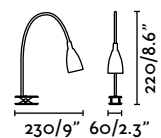
Materials Aluminium + Metal
Aluminio + Metal

V/Hz 100-240V / 50-60 Hz

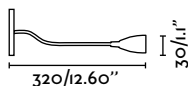
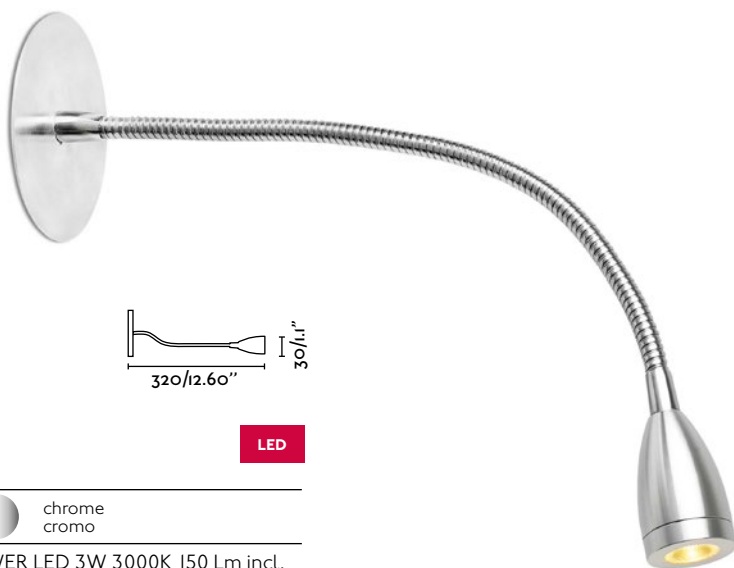
EEL A++

Weight 0.6 kg / 1.32 lb

+ info     



recessed
empotrable



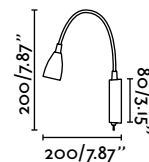
LOKE

Recessed

LED

Ref.	40996	 chrome cromo
Bulb	HIGH POWER LED 3W 3000K 150 Lm incl.	
Materials	Aluminium + Metal Aluminio + Metal	
V/Hz	100-240V / 50-60 Hz	
EEL	A++	
Weight	0.27 kg / 0.60 lb	


+ info



LOKE

Wall Lamp

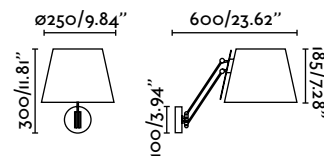
LED

Ref.	40994	 chrome cromo
	41019	 white blanco
	41020	 black negro
Bulb	HIGH POWER LED 3W 3000K 150Lm CRI>80 incl.	
Materials	Aluminium + Metal Aluminio + Metal	
V/Hz	100-240V / 50-60 Hz	
EEL	A++	
Weight	0.6 kg / 1.32 lb	

+ info









STELLA [new]

Wall Lamp

ADJUSTABLE
AJUSTABLE

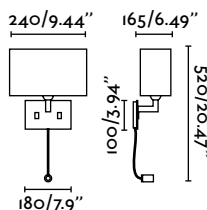
Ref.	63195	 	chrome+white cromo+blanco
Bulb	1xE27 20W not incl. [LED 17452]		
Materials	Metal + Textile Metal + T�xtil		
V/Hz	100-240V / 50-60 Hz		
EEl	A++ to E		
Weight	1.06 kg / 2.34 lb		


+ info



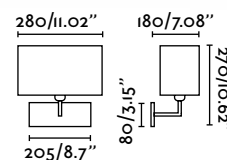
SINKI

Wall Lamp + Reader




Ref.	63187		chrome cromo
Bulb	1xE27 max 60W not incl. [LED 17452] + HIGH POWER LED 1W 4000K 100Lm incl.		
Materials	Metal + Textile Metal + T�xtil		
V/Hz	100-240V / 50-60 Hz		
EEl	A++ to D		
Weight	1.7 kg / 3.75 lb		

+ info



RODA

Wall Lamp

Ref.	62988		matt nickel n�quel mate
Bulb	1xE27 max 60W not incl. [LED 17452]		
Materials	Steel + Textile Acero + T�xtil		
V/Hz	100-240V / 50-60 Hz		
EEl	A++ to E		
Weight	0.9 kg / 1.98 lb		

+ info

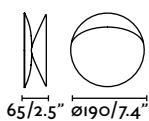


Ovo

Design: Estudi Ribaudí




Ovo provides us with a design that is fully integrated into the spaces, lights them up; it offers us different shapes, obtaining effects and games that enrich them.

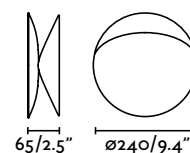
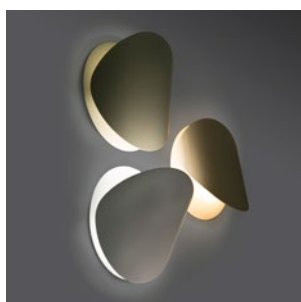




Wall Lamp




ORIENTABLE

Ref.	62105		white blanco
	62106		beige beige
	62107		olive green verde oliva
Bulb	1xR7s 78mm max 75W not incl. [17600]		
Materials	Metal Metal		
V/Hz	100-240V / 50-60 Hz		
EEL	A++ to E		
Weight	0.7 kg / 1.54 lb		



Wall Lamp

ORIENTABLE

Ref.	62108		white blanco
	62109		beige beige
	62110		olive green verde oliva
Bulb	1xR7s 117mm max 100W not incl. [17602]		
Materials	Metal Metal		
V/Hz	100-240V / 50-60 Hz		
EEL	A++ to E		
Weight	1.12 kg / 2.47 lb		

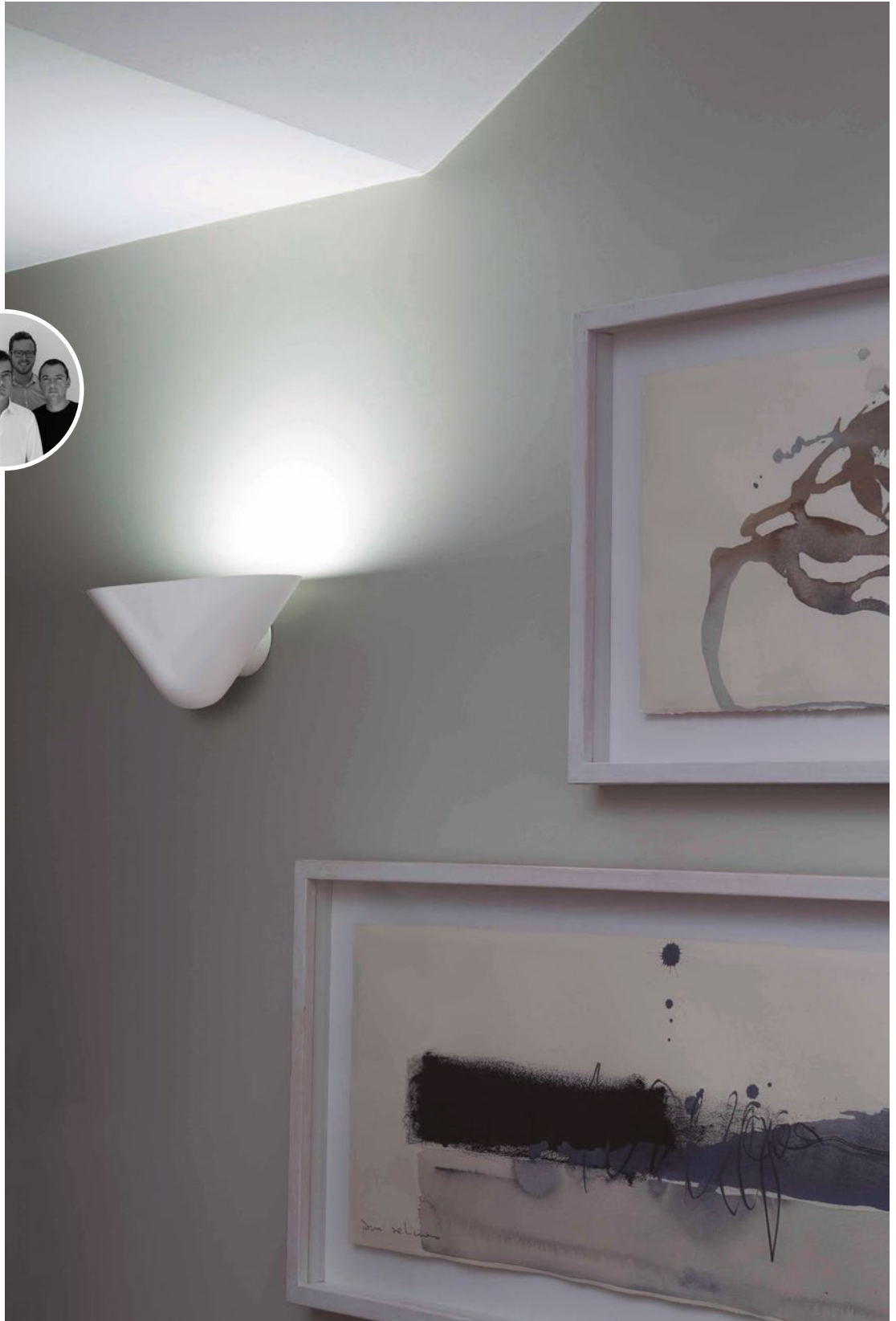


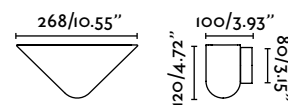
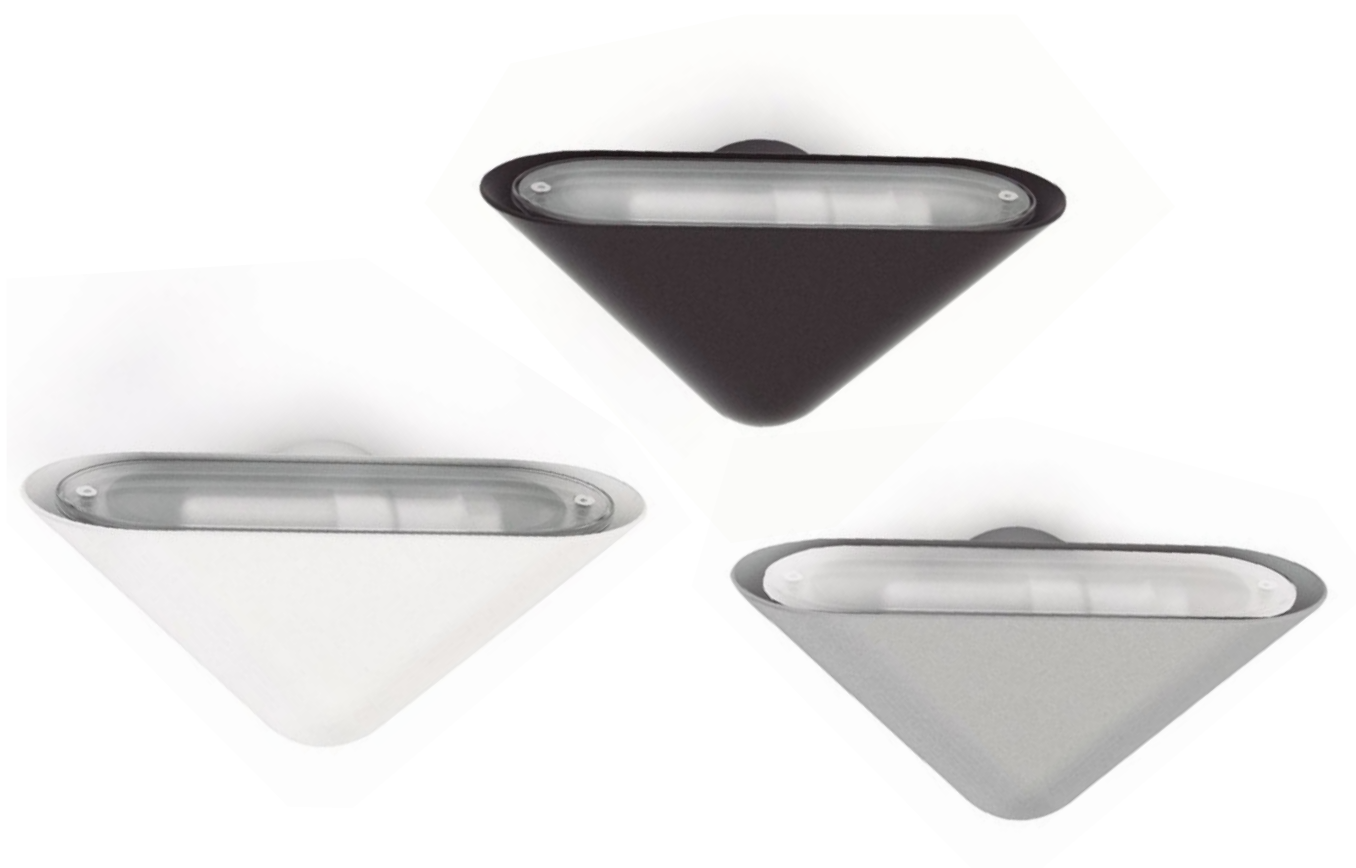
Bird

Design: Estudi Ribaudí






Bird is a wall lamp inspired by japanese origami, a culture that sought permanent harmony in open spaces.






Wall Lamp

2 POSITIONS
2 POSICIONES

Ref.	75509		white blanco
	75510		grey gris
	75511		black negro
Bulb	1xE27 max 20W not incl. [LED 17454]		
Materials	Die Cast Aluminium + Translucent Polycarbonate Aluminio Inyectado + Policarbonato Translúcido		
V/Hz	100-240V / 50-60 Hz		
EEL	A++ to B		
Weight	0.7 kg / 1.54 lb		

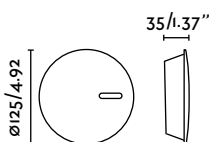
+ info    

Code

Design: Estudi Ribaudí

Wind is a
fan of simple shapes
designed to provide
comfort and relaxation.



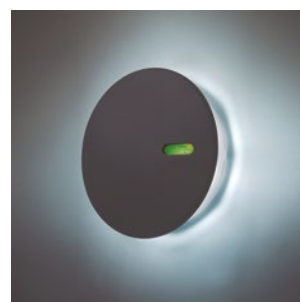


Wall Lamp LED

Ref.	71526 white blanco
	71527 dark grey gris oscuro
Bulb	SMD LED 0,2W 4000K 150Lm incl.
Materials	Polycarbonate Policarbonato
V/Hz	220-240V / 50-60 Hz
EEl	A++ to A
Weight	0.2 kg / 0.44 lb

+ info



3 Stickers incl.



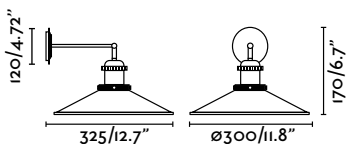


MARLIN

Wall Lamp

Ref.	65133	 	old gold+black oro envejecido+negro
Bulb	1xE27 max 40W not incl. [10310]		
Materials	Metal + Glass Metal + Cristal		
V/Hz	100-240V / 50-60 Hz		
EEL	A++ to E		
Weight	0.9 kg / 1.98 lb		

+ info




See Suspended
Ver Colgante
Pag_145

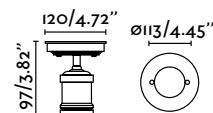


ART [new]

Wall Lamp

Ref.	64138		old gold oro envejecido
Bulb	1xE27 60W not incl. [LED 17425]		
Materials	Metal Metal		
V/Hz	100-240V / 50-60 Hz		
EEL	A++ to E		
Weight	0.33 kg / 0.73 lb		

+ info

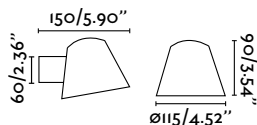


2 POSITIONS
2 POSICIONES



See Suspended
Ver Colgante
Pag_149





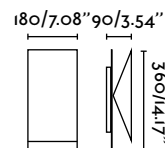
GINA

Wall Lamp

IP44

Ref.	71363		dark grey gris oscuro
	71366		white blanco
	71367		black negro
Bulb	1xGU10 max 35W not incl. [LED 17324]		
Materials	Die Cast Aluminium + Glass Aluminio Inyectado + Cristal		
V/Hz	100-240V / 50-60 Hz		
EEL	A++ to E		
Weight	0.44 kg / 0.97 lb		

+ info



HOMS

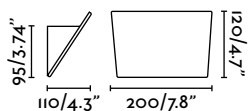
Wall Lamp

BULB INCLUDED
BOMBILLA INCLUIDA

ORIENTABLE

Ref.	63167		white blanco
Bulb	1xR7s JP78 max 100W incl.		
Materials	Metal Metal		
V/Hz	220-240V / 50-60 Hz		
EEL	A to D		
Weight	1.93 kg / 4.25 lb		

+ info



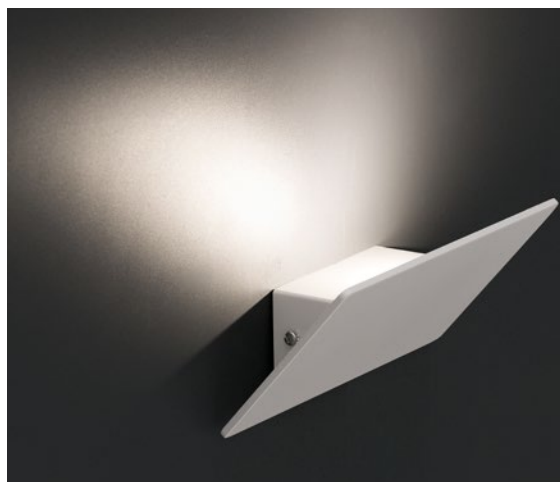
DALLAS

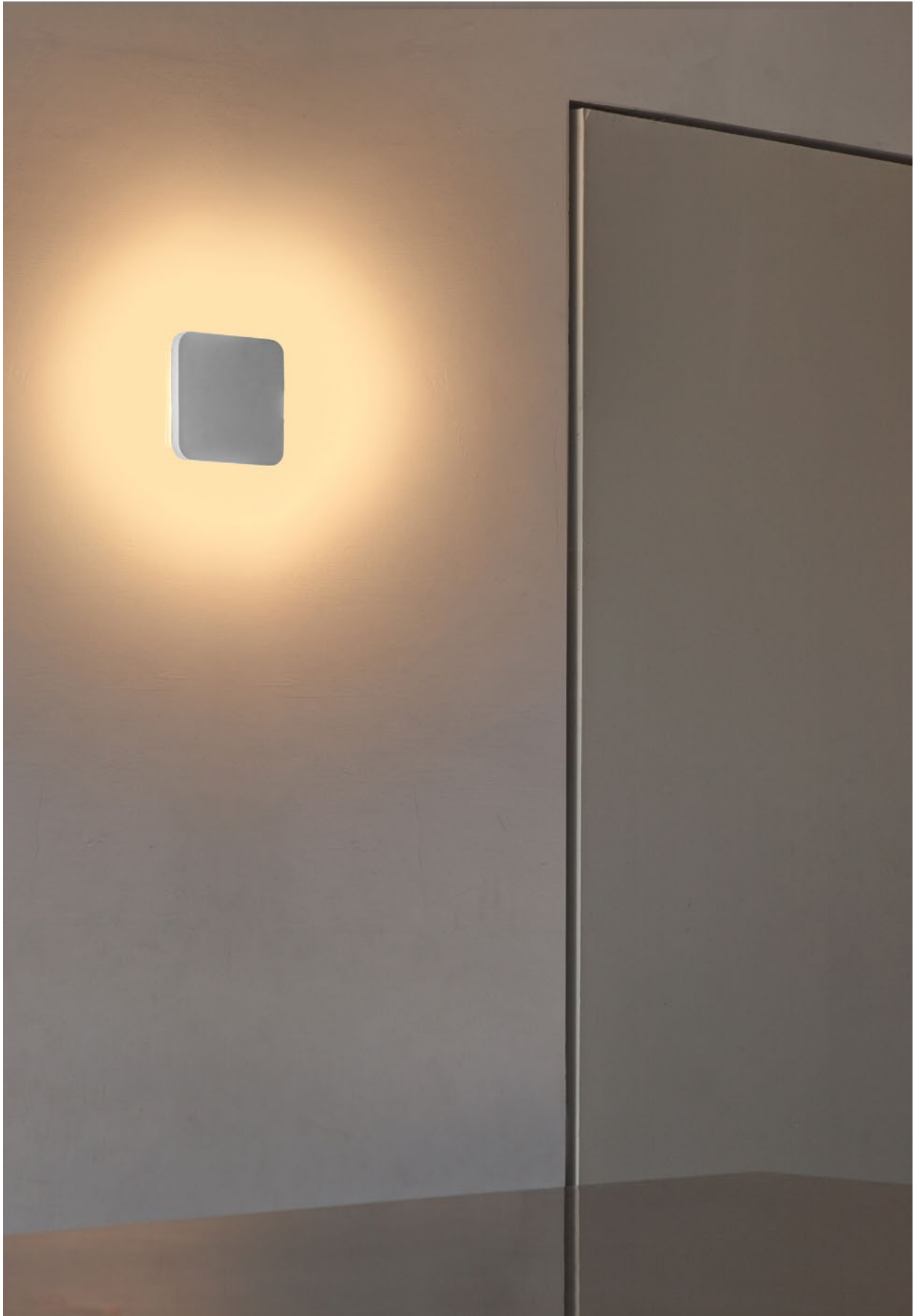
Wall Lamp

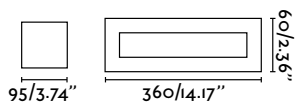
LED

Ref.	63199		white blanco
Bulb	COB LED 5W 3000K 435Lm incl.		
Materials	Aluminium Aluminio		
V/Hz	100-240V / 50-60 Hz		
EEL	A++ to A		
Weight	0.37 kg / 0.82 lb		

+ info








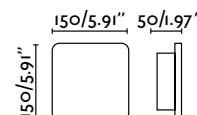
OLAF [new]

Wall Lamp

UP & DOWN
ARRIBA Y ABAJO PLASTER
YESO

Ref.	63278	 white blanco
Bulb	2xE14 40W not incl. [LED 17451]	
Materials	Plaster + Translucent Acrylic Yeso + Acrílico Translúcido	
V/Hz	100-240V / 50-60 Hz	
EEL	A++ to E	
Weight	1.52 kg / 3.35 lb	


+ info



ELSA [new]

Wall Lamp

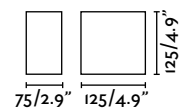
LED PLASTER
YESO

Ref.	63279	 white blanco
Bulb	SMD LED 8W 2700K 300Lm incl.	
Materials	Plaster + Translucent Acrylic Yeso + Acrílico Translúcido	
V/Hz	100-240V / 50 Hz	
EEL	A++ to A	
Weight	0.91 kg / 2.01 lb	

+ info








OSLO

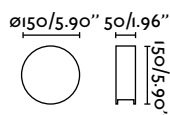
Wall Lamp

UP & DOWN
ARRIBA Y ABAJO

PLASTER
YESO

Ref.	63284	 white blanco
Bulb	1xG9 40W not incl. [LED 17443]	
Materials	Plaster Yeso	
V/Hz	100-240V / 50-60 Hz	
EEL	A++ to E	
Weight	0.84 kg / 1.85 lb	

+ info  




GROE

Wall Lamp

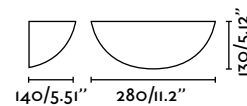
LED

UP & DOWN
ARRIBA Y ABAJO

PLASTER
YESO

Ref.	63288	 white blanco
Bulb	HIGH POWER LED 2W 3000K 200Lm incl.	
Materials	Plaster Yeso	
V/Hz	100-240V / 50-60 Hz	
EEL	A++	
Weight	1 kg / 2.20 lb	


+ info   



SNOW

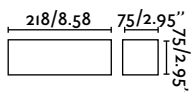
Wall Lamp

PLASTER
YESO

Ref.	63285	 white blanco
Bulb	1xE14 max 40W not incl. [LED 17451]	
Materials	Plaster Yeso	
V/Hz	100-240V / 50-60 Hz	
EEL	A	
Weight	1.43 kg / 3.15 lb	

+ info   




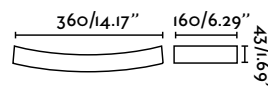


EACO

Wall Lamp

PLASTER YESO


Ref.	63176  white blanco
Bulb	1xG9 max 40W not incl. [LED 17443]
Materials	Plaster Yeso
V/Hz	100-240V / 50-60 Hz
EEL	A++ to E
Weight	0.8 kg / 1.76 lb

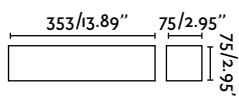


EACO

Wall Lamp

PLASTER YESO


Ref.	63178  white blanco
Bulb	1xR7s JP78mm max 100W not incl. [17600]
Materials	Plaster Yeso
V/Hz	100-240V / 50-60 Hz
EEL	A++ to E
Weight	1.92 kg / 4.23 lb

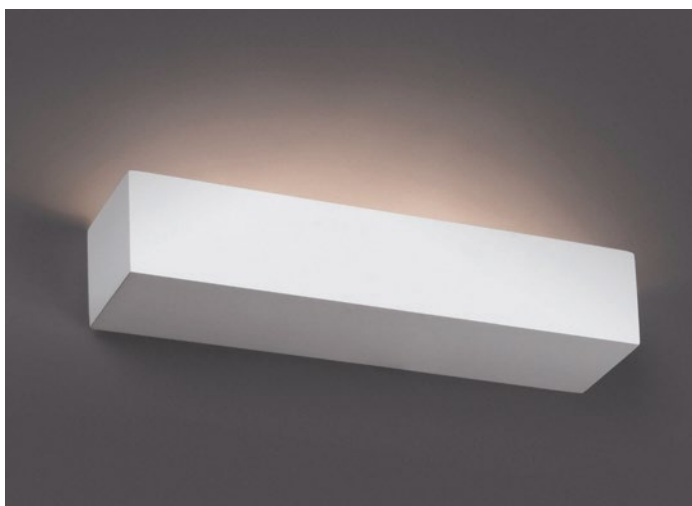


EACO

Wall Lamp

PLASTER YESO

Ref.	63177  white blanco
Bulb	2xG9 max 40W not incl. [LED 17443]
Materials	Plaster Yeso
V/Hz	100-240V / 50-60 Hz
EEL	A++ to E
Weight	1.4 kg / 3.09 lb






CHERAS

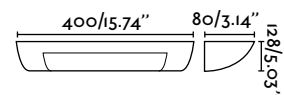
**Wall
Lamp**

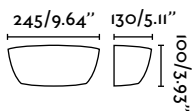
UP & DOWN
ARRIBA Y ABAJO

PLASTER
YESO

Ref.	63175	 white blanco
Bulb	1xR7s JP78mm max 100W not incl. [17600]	
Materials	Plaster Yeso	
V/Hz	100-240V / 50-60 Hz	
EEL	A++ to E	
Weight	1.9 kg / 4.19 lb	

+ info






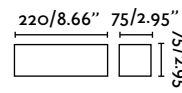
CHERAS

Wall Lamp

UP & DOWN
ARRIBA Y ABAJO

PLASTER
YESO

Ref.	63173	 white blanco
Bulb	1xR7s JP78mm max 100W not incl. [17600]	
Materials	Plaster Yeso	
V/Hz	100-240V / 50-60 Hz	
EEL	A++ to E	
Weight	1.1 kg / 2.43 lb	




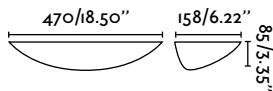
CHERAS

Wall Lamp

UP & DOWN
ARRIBA Y ABAJO

PLASTER
YESO


Ref.	63174	 white blanco
Bulb	1xG9 max 40W not incl. [15615]	
Materials	Plaster Yeso	
V/Hz	220-240V / 50-60 Hz	
EEL	A++ to E	
Weight	0.83 kg / 1.83 lb	



CHERAS

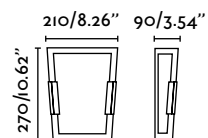
Wall Lamp

PLASTER
YESO

Ref.	63172	 white blanco
Bulb	1xR7s JP78mm max 100W not incl. [17600]	
Materials	Plaster Yeso	
V/Hz	100-240V / 50-60 Hz	
EEL	A++ to E	
Weight	1.94 kg / 4.28 lb	







TWIN

Wall Lamp

By Àlex&Manel Llusçà

Ref.	66185		matt nickel níquel mate
	66186		rust brown marrón óxido
Bulb	2xE14 max 40W not incl. [LED 17451]		
Materials	Metal + Translucent Glass Metal + Cristal Translúcido		
V/Hz	100-240V / 50-60 Hz		
EEL	A++ to E		
Weight	1.8 kg / 3.97 lb		


+ info  



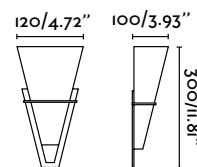
TWIN

Wall Lamp

By Àlex&Manel Llusçà

Ref.	66183		matt nickel níquel mate
Bulb	2xE27 max 60W not incl. [LED 17452]		
Materials	Metal + Translucent Glass Metal + Cristal Translúcido		
V/Hz	100-240V / 50-60 Hz		
EEL	A++ to E		
Weight	1.8 kg / 3.97 lb		

+ info  



CONO

Wall Lamp

By Àlex&Manel Llusçà

Ref.	66137		rust brown marrón óxido
Bulb	2xE14 max 60W not incl. [LED 17451]		
Materials	Metal + Rustic Glass Metal + Cristal Rústico		
V/Hz	100-240V / 50-60 Hz		
EEL	A++ to E		
Weight	1.5 kg / 3.31 lb		


+ info 

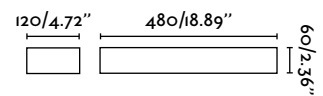


AMBO

Wall
Lamp

UP & DOWN
ARRIBA Y ABAJO

Ref.	63200	 polished aluminium aluminio pulido
Bulb	1 x 2G11 max 36W not incl. [15923]	
Materials	Aluminium + Translucent Glass Aluminio + Cristal Translúcido	
V/Hz	220-240V / 50-60 Hz	
EEl	A++ to E	
Weight	1.93 kg / 4.25 lb	

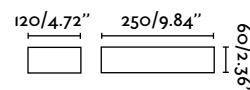



+ info



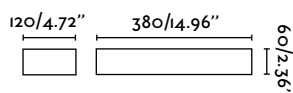
BALLAST 




**AMBO****Wall Lamp**UP & DOWN
ARRIBA Y ABAJO

Ref.	63186  polished aluminium aluminio pulido
Bulb	1xE27 max 15W not incl. [LED 17452]
Materials	Aluminium + Translucent Glass Aluminio + Cristal Translúcido
V/Hz	220-240V / 50-60 Hz
EEL	A++ to B
Weight	1 kg / 2.20 lb


+ info

**AMBO****Wall Lamp**UP & DOWN
ARRIBA Y ABAJO

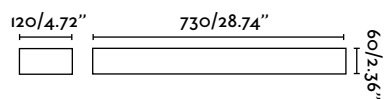
Ref.	63202  polished aluminium aluminio pulido
Bulb	2xR7s max 100W not incl. [17601]
Materials	Aluminium + Translucent Glass Aluminio + Cristal Translúcido
V/Hz	220-240V / 50-60 Hz
EEL	A++ to E
Weight	1.47 kg / 3.24 lb

+ info

**AMBO****Wall Lamp**UP & DOWN
ARRIBA Y ABAJO

Ref.	63201  polished aluminium aluminio pulido
Bulb	2x2G II max 24W not incl. [97223024]
Materials	Aluminium + Translucent Glass Aluminio + Cristal Translúcido
V/Hz	220-240V / 50-60 Hz
EEL	A++ to E
Weight	2.54 kg / 5.60 lb


+ info



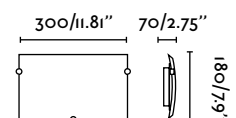


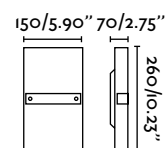
LIRIA

Wall Lamp

Ref.	63156  matt nickel níquel mate
Bulb	1xE27 max 60W not incl. [LED 17452]
Materials	Metal + Opal Glass Metal + Cristal Opal
V/Hz	100-240V / 50-60 Hz
EEI	A++ to E
Weight	0.8 kg / 1.76 lb


+ info 





ÁNGULO


Wall Lamp

Ref.	63069  matt nickel níquel mate
Bulb	2xE14 max 40W not incl. [LED 17451]
Materials	Metal + Stainless Steel + Translucent Glass Metal + Acero Inoxidable + Cristal Translúcido
V/Hz	100-240V / 50-60 Hz
EEL	A++ to E
Weight	0.93 kg / 2.05 lb

+ info 

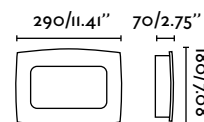
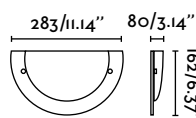
VERA

Wall Lamp

Ref.	63027  grey gris
Bulb	1xE27 max 60W not incl. [LED 17452]
Materials	Steel + Translucent Glass Acero + Cristal Translúcido
V/Hz	100-240V / 50-60 Hz
EEL	A++ to E
Weight	0.51 kg / 1.12 lb


+ info 

Sale: 10 units and multiples of 10
 Venta: 10 uds y múltiplos de 10
 Vente: 10 unités et multiples de 10
 Vendita: 10 unità e multipli di 10.



IBISCUS

Wall Lamp

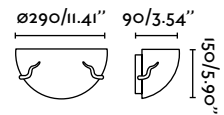
Ref.	63151  matt nickel níquel mate
Bulb	1xE27 max 60W not incl. [LED 17452]
Materials	Metal + Translucent Glass Metal + Cristal Translúcido
V/Hz	100-240V / 50-60 Hz
EEL	A++ to E
Weight	1.1 kg / 2.43 lb

+ info 

HF

Until stock exhaustion
 Hasta final de stock
 Jusqu'à la fin de stock

HF

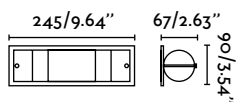


DATA

Wall Lamp


Ref.	63090	 matt nickel níquel mate
Bulb	1xE27 max 60W not incl. [LED 17452]	
Materials	Steel + Translucent Glass Acero + Cristal Translúcido	
V/Hz	100-240V / 50-60 Hz	
EEL	A++ to E	
Weight	0.7 kg / 1.54 lb	

+ info 



SINTRA

Wall Lamp

Ref.	63040  matt nickel níquel mate
Bulb	1xE14 max 40W not incl. [LED 17281]
Materials	Metal + Opal Glass Metal + Cristal Opal
V/Hz	100-240V / 50-60 Hz
EEL	A++ to E
Weight	0.63 kg / 1.39 lb

HF

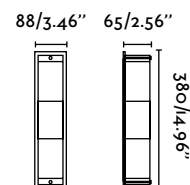


+ info 




HF

Until stock exhaustion
Hasta final de stock
Jusqu'à la fin de stock



SINTRA

Wall Lamp

Ref.	63041  matt nickel níquel mate
Bulb	2xE14 max 40W not incl. [LED 17281]
Materials	Metal + Opal Glass Metal + Cristal Opal
V/Hz	100-240V / 50-60 Hz
EEL	A++ to E
Weight	0.9 kg / 1.98 lb


HF

+ info 

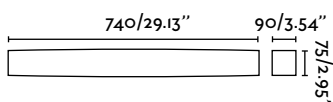
PORTOS

Wall Lamp

BULB INCLUDED
BOMBILLA INCLUIDA

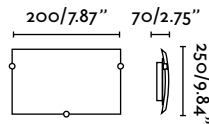
Ref.	63105  grey gris
Bulb	1xT5 13W incl.
Materials	Metal + Aluminium Metal + Aluminio
V/Hz	220-240V / 50-60 Hz
EEL	A to B
Weight	2.42 kg / 5.34 lb


+ info  



DIULA

Wall Lamp



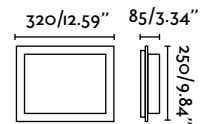
Ref.	62987	 matt nickel níquel mate
Bulb	1xE27 max 60W not incl. [LED 17453]	
Materials	Metal + Translucent Glass Metal + Cristal Translúcido	
V/Hz	100-240V / 50-60 Hz	
EEl	A++ to E	
Weight	1.05 kg / 2.31 lb	


+ info 



DIULA

Wall Lamp

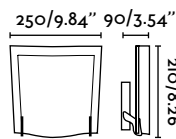


Ref.	62986	 matt nickel níquel mate
Bulb	2xE27 max 60W not incl. [LED 17453]	
Materials	Metal + Translucent Glass Metal + Cristal Translúcido	
V/Hz	100-240V / 50-60 Hz	
EEl	A++ to E	
Weight	1.8 kg / 3.97 lb	

+ info 

OLA

Wall Lamp



Ref.	63064	 matt nickel níquel mate
Bulb	1xE14 max 60W not incl. [LED 17451]	
Materials	Steel + Translucent Glass Acero + Cristal Translúcido	
V/Hz	100-240V / 50-60 Hz	
EEl	A++ to E	
Weight	0.9 kg / 1.98 lb	


+ info 



OLA

Wall Lamp



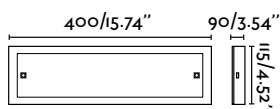
Ref.	63065  matt nickel níquel mate
Bulb	2xE14 max 60W not incl. [LED 17451]
Materials	Steel + Translucent Glass Acero + Cristal Translúcido
V/Hz	100-240V / 50-60 Hz
EEL	A++ to E
Weight	1.43 kg / 3.15 lb


+ info 



SUNNY

Wall Lamp

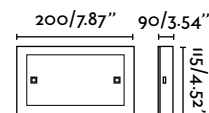



Ref.	63047  chrome cromo
Bulb	2xE14 max 40W not incl. [LED 17281]
Materials	Metal + Translucent Glass Metal + Cristal Translúcido
V/Hz	100-240V / 50-60 Hz
EEL	A++ to E
Weight	1.1 kg / 2.43 lb

+ info  

SUNNY

Wall Lamp

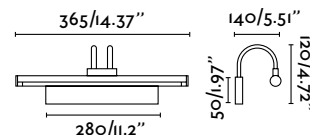


Ref.	63046  chrome cromo
Bulb	1xE14 max 40W not incl. [LED 17281]
Materials	Metal + Translucent Glass Metal + Cristal Translúcido
V/Hz	100-240V / 50-60 Hz
EEL	A++ to E
Weight	0.6 kg / 1.32 lb

+ info  








DEGAS

Wall
Lamp
Pictures

BULB INCLUDED
BOMBILLA INCLUIDA

Ref.	61070	 grey gris
Bulb	1xT5 8W 2700K incl.	
Materials	Metal Metal	
V/Hz	220-240V / 50-60 Hz	
EEL	A to B	
Weight	0.7 kg / 1.54 lb	


+ info  **BALLAST** 



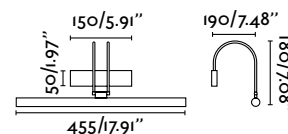
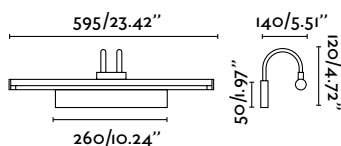
DEGAS

Wall
Lamp
Pictures

BULB INCLUDED
BOMBILLA INCLUIDA

Ref.	61071	 grey gris
Bulb	1xT5 13W 2700K incl.	
Materials	Metal Metal	
V/Hz	220-240V / 50-60 Hz	
EEL	A to B	
Weight	0.88 kg / 1.94 lb	



+ info  **BALLAST** 



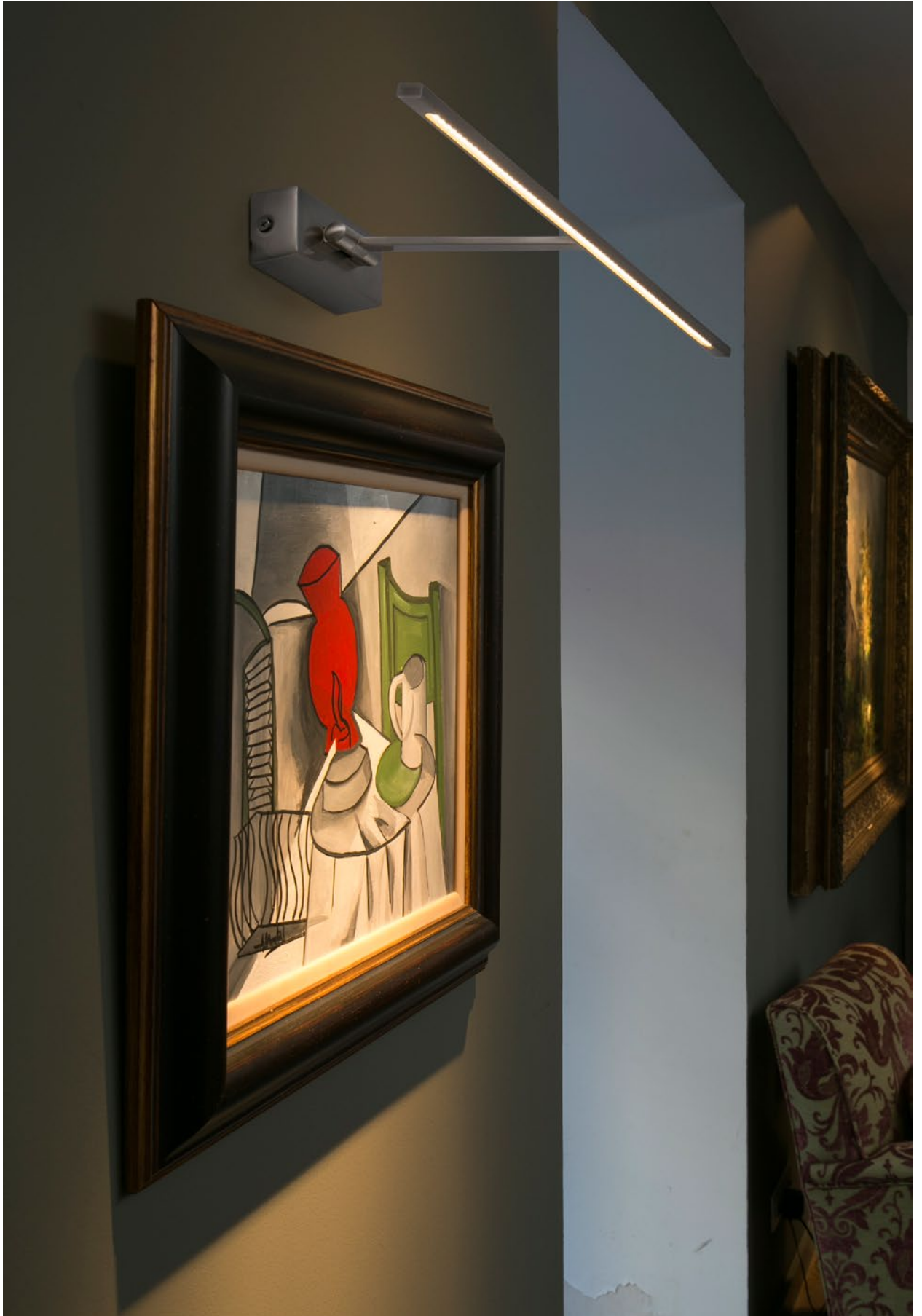
KLIMT

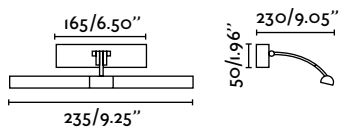
Wall
Lamp
Pictures

LED

Ref.	61048	 matt nickel níquel mate
	61049	 old gold oro envejecido
Bulb	SMD LED 6W 3000K 429Lm incl.	
Materials	Aluminium + Polycarbonate Aluminio + Policarbonato	
V/Hz	220-240V / 50-60 Hz	
EEL	A++	
Weight	1 kg / 2.20 lb	

+ info  **DRIVER** 






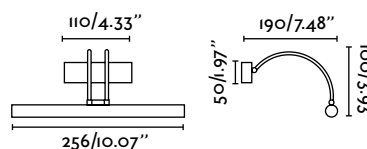
LUMIERE

Wall
Lamp
Pictures

BULB INCLUDED
BOMBILLA INCLUIDA

Ref.	61066  matt nickel níquel mate
Bulb	2xG9 40W incl. [LED 17440]
Materials	Metal Metal
V/Hz	220-240V / 50-60 Hz
EEl	A to D
Weight	0.78 kg / 1.72 lb


+ info



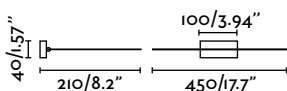
HENLEIN

Wall
Lamp
Pictures

LED

Ref.	61064  matt nickel níquel mate
Bulb	SMD LED 3W 4100K 190Lm incl.
Materials	Metal Metal
V/Hz	220-240V / 50-60 Hz
EEl	A++
Weight	0.65 kg / 1.43 lb


+ info



MONET

Wall
Lamp
Pictures

LED

Ref.	61068  matt nickel níquel mate
Bulb	SMD LED 6W 3000K incl.
Materials	Metal Metal
V/Hz	100-240V / 50-60 Hz
Weight	0.59 kg / 1.30 lb

+ info

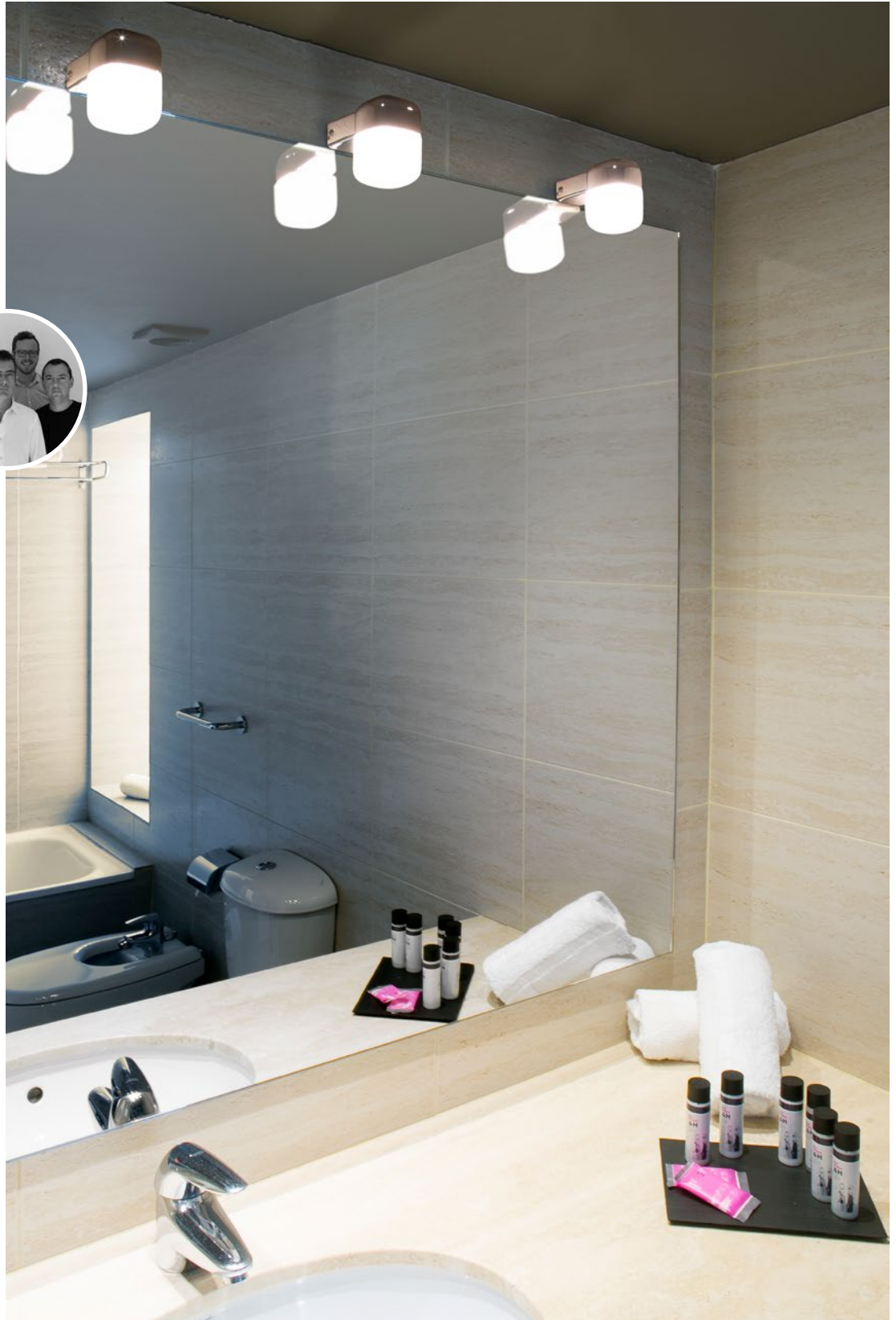


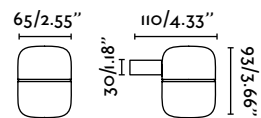
Ikon & Mild

Design: Estudi Ribaudí




Designs
for bathrooms
which aim to soften the
hardness of these spaces,
creating a friendlier
personality.





MILD

Wall Lamp

Ref.	63326	 chrome cromo	HF
Bulb	1xG9 28W not incl. [I5615]		
Materials	Metal + Opal Glass Metal + Cristal Opal		
V/Hz	100-240V / 50-60 Hz		
EEl	A++ to E		
Weight	0.39 kg / 0.86 lb		

+ info

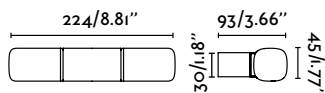



HF

Until stock exhaustion
Hasta final de stock
Jusqu'à la fin de stock

IKON

Wall Lamp

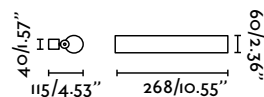


Ref.	63325	 chrome cromo
Bulb	2xG9 28W not incl. [I5615]	
Materials	Metal + Opal Glass Metal + Cristal Opal	
V/Hz	100-240V / 50-60 Hz	
EEl	A++ to E	
Weight	0.72 kg / 1.59 lb	

+ info









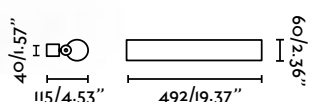
SIRET

Wall Lamp

LED

Ref.	64177	 chrome cromo
Bulb	SMD LED 16W 2700K 600Lm CRI>80 incl.	
Materials	Aluminium + Opal PMMA Aluminio + PMMA Opal	
V/Hz	100-240V / 50-60 Hz	
EEl	A	
Weight	1.06 kg / 2.34 lb	


+ info   



SIRET

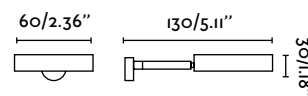
Wall Lamp

LED

Ref.	64178	 chrome cromo
Bulb	SMD LED 8W 2700K 1200Lm CRI>80 incl.	
Materials	Aluminium + Opal PMMA Aluminio + PMMA Opal	
V/Hz	100-240V / 50-60 Hz	
EEl	A	
Weight	1.57 kg / 3.46 lb	

+ info   



**CALDA****Wall Lamp****LED**

Ref.	63147	chrome cromo
Bulb	SMD LED 5W 4000K 400Lm incl.	
Materials	Aluminium + Translucent Polycarbonate Aluminio + Policarbonato Translúcido	
V/Hz	100-240V / 50-60 Hz	
EEL	A+	
Weight	0.27 kg / 0.60 lb	

HF

+ info

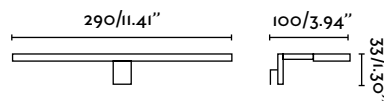


HF Until stock exhaustion
Hasta final de stock
Jusqu'à la fin de stock

TO PLACE ON MIRROR
FIJACION EN ESPEJO5
MM**TERMA****Wall Lamp****LED**

Ref.	63148	chrome cromo
Bulb	SMD LED 5W 4000K 400Lm incl.	
Materials	Steel + Aluminium + Translucent PMMA Acero + Aluminio + PMMA Translúcido	
V/Hz	100-240V / 50-60 Hz	
EEL	A++ to A	
Weight	0.6 kg / 1.32 lb	


+ info



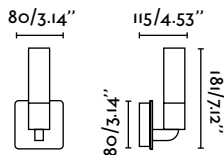


LAOS

Wall Lamp


Ref.	63320  chrome cromo
Bulb	1xE14 40W not incl. [LED 17450]
Materials	Aluminium + Opal Glass Aluminio + Cristal Opal
V/Hz	100-240V / 50-60 Hz
EEl	A++ to E
Weight	0.6 kg / 1.32 lb

+ info  

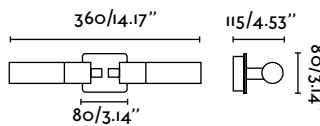


LAOS

Wall Lamp

Ref.	63321  chrome cromo
Bulb	2xE14 40W not incl. [LED 17450]
Materials	Aluminium + Opal Glass Aluminio + Cristal Opal
V/Hz	100-240V / 50-60 Hz
EEl	A++ to E
Weight	1 kg / 2.20 lb

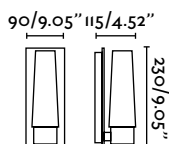
+ info  






DOKA

Wall Lamp



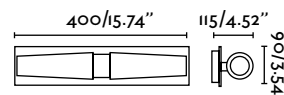
Ref.	63322  chrome cromo
Bulb	1xE14 28W not incl. [LED 17450]
Materials	Steel + Opal Glass Acero + Cristal Opal
V/Hz	100-240V / 50-60 Hz
EEL	A++ to E
Weight	0.9 kg / 1.98 lb


+ info  



DOKA

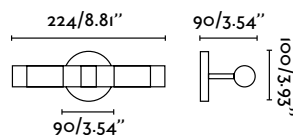
Wall Lamp



Ref.	63323  chrome cromo
Bulb	2xE14 28W not incl. [LED 17450]
Materials	Steel + Opal Glass Acero + Cristal Opal
V/Hz	100-240V / 50-60 Hz
EEL	A++ to E
Weight	1.3 kg / 2.87 lb


+ info  





RELAX


Wall Lamp

Ref.	63043  chrome cromo
Bulb	2xG9 max 28W not incl. [15615]
Materials	Metal + Translucent Glass Metal + Cristal Translúcido
V/Hz	100-240V / 50-60 Hz
EEL	A++ to E
Weight	0.5 kg / 1.10 lb

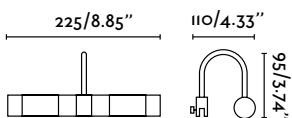
+ info  

RELAX

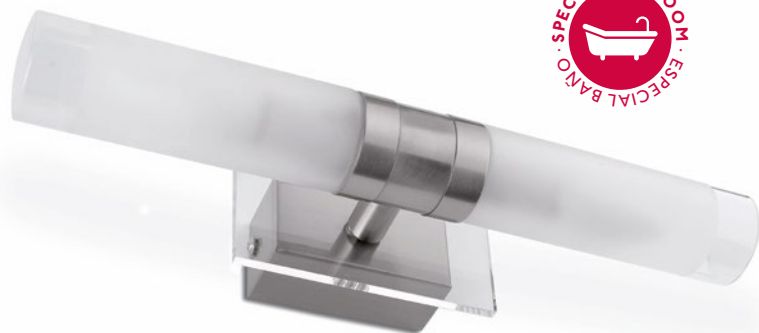
Wall Lamp

Ref.	63038  chrome cromo
Bulb	2xG9 max 28W not incl. [15615]
Materials	Metal + Translucent Glass Metal + Cristal Translúcido
V/Hz	100-240V / 50-60 Hz
EEL	A++ to B
Weight	0.49 kg / 1.08 lb

+ info  




TO PLACE ON MIRROR
FIJACIÓN EN ESPEJO

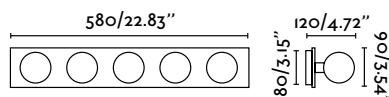


NIGER

Wall Lamp

Ref.	63120  matt nickel níquel mate
Bulb	2xE14 40W not incl. [LED 17450]
Materials	Aluminium + Metal + Translucent Glass Aluminio + Metal + Cristal Translúcido
V/Hz	100-240V / 50-60 Hz
EEL	A++ to E
Weight	0.75 kg / 1.65 lb

+ info 



LASS

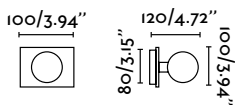
Wall
Lamp

BULB INCLUDED
BOMBILLA INCLUIDA

Ref.	63009	○	mirror espejo
Bulb	5xG9 28W incl. [LED 17443]		
Materials	Metal + Glass Metal + Cristal		
V/Hz	220-240V / 50-60 Hz		
EEL	A++ to B		
Weight	2.3 kg / 5.07 lb		

+ info





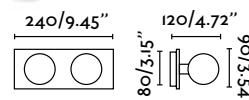
LASS-1 [new]

Wall Lamp

BULB INCLUDED BOMBILLA INCLUIDA

Ref.	62974		mirror espejo
Bulb	1xG9 28W incl. [LED 17443]		
Materials	Metal + Glass Metal + Cristal		
V/Hz	220-240V / 50-60 Hz		
EEL	C to E		
Weight	0.42 kg / 0.93 lb		

+ info  



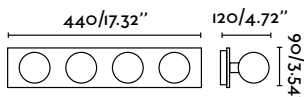
LASS-2 [new]

Wall Lamp

BULB INCLUDED BOMBILLA INCLUIDA

Ref.	63006		mirror espejo
Bulb	2xG9 28W incl. [LED 17443]		
Materials	Metal + Glass Metal + Cristal		
V/Hz	220-240V / 50-60 Hz		
EEL	C to E		
Weight	0.84 kg / 1.85 lb		

+ info  



LASS

Wall Lamp

BULB INCLUDED BOMBILLA INCLUIDA

Ref.	63008		mirror espejo
Bulb	4xG9 28W incl. [LED 17443]		
Materials	Metal + Glass Metal + Cristal		
V/Hz	220-240V / 50-60 Hz		
EEL	A++ to B		
Weight	1.69 kg / 3.73 lb		


+ info  



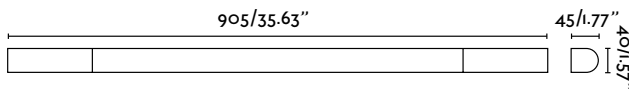
INDO

Wall Lamp

LED

Ref.	63146		chrome cromo
Bulb	SMD LED 9W 4000K 600Lm incl.		
Materials	Metal + Aluminium + Opal PMMA Metal + Aluminio + PMMA Opal		
V/Hz	100-240V / 50-60 Hz		
EEL	A		
Weight	1.07 kg / 2.36 lb		

+ info   



More wall fixtures



Berni
27



Conik
17



Creta
84



Fusta
35



Hotel
47



Lara
95



Linda
61



Link
63



Lise
77



Lupe
33



Mitic
93



Mix
55



Moma
81



Nudos
101



Ora
79



Plec
69



Retro
19



Saba
96



Sac
74



Sweet
51



Thana
89



Vesper
41



Volta
37



Winch
73

Acacia	307	Nan	281
Adra	304	Pote	285
Azor	311	Rel	282
Cloe	297	Ronda	299
Coccote	286	Seven	289
Copic	281	Sogo	291
Cora	302	Squad	278
Dante	306	Sven	283
Data	306	Tecto	276
Dino	307	Tola	295
Foro	298	Vera	305
Iris	293	Vuk	297
Janet	289	Yuca	303
Kalo	315		
Kao	297		
Leni	305		
Liria	309		
Logos	301		





TECTO AR III

Ceiling Lamp

Ref.	63274		white blanco
	63275		black negro

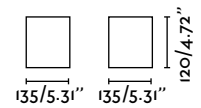
Bulb	1 x AR III 50W not incl. [LED 17512] LED transformer not incl. [98111051] Halogen transformer not incl. [98111050]
-------------	--

Materials	Aluminium Aluminio
------------------	-----------------------

V/Hz	12V
-------------	-----

EEL	A++ to E
------------	----------

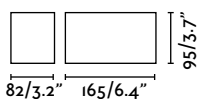
Weight	1.03 kg / 2.27 lb
---------------	-------------------



+ info  

TECTO

Ceiling Lamp



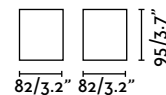
Ref.	63272		white blanco
	63273		black negro
Bulb	2xGU10 50W not incl. [LED 17324]		
Materials	Aluminium Aluminio		
V/Hz	100-240V / 50-60 Hz		
EEL	A++ to E		
Weight	0.63 kg / 1.39 lb		

+ info



TECTO

Ceiling Lamp

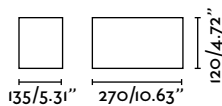


Ref.	63270		white blanco
	63271		black negro
Bulb	1xGU10 50W not incl. [LED 17324]		
Materials	Aluminium Aluminio		
V/Hz	100-240V / 50-60 Hz		
EEL	A++ to E		
Weight	0.4 kg / 0.88 lb		

+ info

TECTO AR III

Ceiling Lamp



Ref.	63276		white blanco
	63277		black negro
Bulb	2xAR III 50W not incl. [LED 17512] LED transformer not incl. [98III051] Halogen transformer not incl. [98III050]		
Materials	Aluminium Aluminio		
V/Hz	12V		
EEL	A++ to E		
Weight	2 kg / 4.41 lb		



+ info



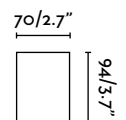


SQUAD

Ceiling Lamp

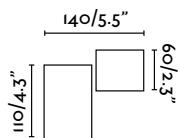
Ref.	63216	 matt white blanco mate
	63239	 polished aluminium aluminio pulido
Bulb	1 x GU10 max 35W not incl. [LED 17316]	
Materials	Aluminium + Steel Aluminio + Acero	
V/Hz	100-240V / 50-60 Hz	
EEL	A++ to E	
Weight	0.34 kg / 0.75 lb	

+ info



SQUAD

Ceiling Lamp

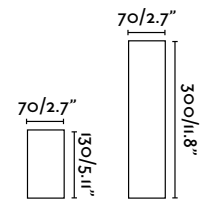


Ref.	63215		matt white blanco mate
	63238		polished aluminium aluminio pulido
Bulb	1xGU10 max 50W not incl. [LED 17316]		
Materials	Aluminium + Steel Aluminio + Acero		
V/Hz	100-240V / 50-60 Hz		
EEl	A++ to E		
Weight	0.59 kg / 1.30 lb		

+ info



**ROTATING BASE
BASE CON ROTACIÓN**



REF. 63217
REF. 63240 **REF. 63218**

SQUAD

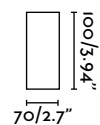
Ceiling Lamp


Ref.	63217		matt white blanco mate
	63218		matt white blanco mate
	63240		polished aluminium aluminio pulido

Bulb	1xGU10 max 35W not incl. [LED 17316]		
Materials	Aluminium + Steel Aluminio + Acero		
V/Hz	100-240V / 50-60 Hz		
EEl	A++ to E		
Weight	0.48 kg / 1.06 lb		

+ info




**NAN****Ceiling Lamp**

Ref.	64190	 white blanco
Bulb	1xGU10 max 50W not incl. [LED 17324]	
Materials	Aluminium Aluminio	
V/Hz	100-240V / 50-60 Hz	
EEl	A++ to E	
Weight	0.49 kg / 1.08 lb	

+ info

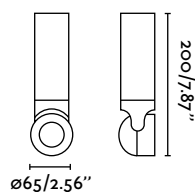
**COPIC****Ceiling Lamp****LED**

Ref.	63237	 matt black negro mate
Bulb	COB LED 7W 3000K 600Lm incl.	
Materials	Aluminium Aluminio	
V/Hz	220-240V / 50-60 Hz	
EEl	A++	
Weight	0.6 kg / 1.32 lb	

+ info



HF



HF



Until stock exhaustion
Hasta final de stock
Jusqu'à la fin de stock

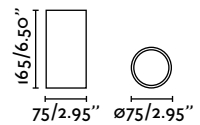


REL

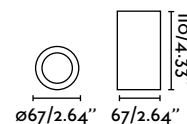
Ceiling Lamp


LED

Ref.	64198	 white blanco
	64199	 black negro
Bulb	COB LED 15W 2700K 340Lm CRI>80 incl.	
Materials	Aluminium + PMMA Aluminio + PMMA	
V/Hz	100-240V / 50-60 Hz	
Weight	0.67 kg / 1.48 lb	

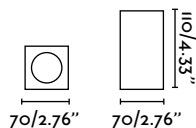



+ info   

**SVEN [new]****Ceiling Lamp**

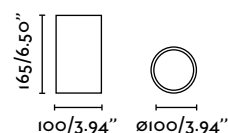
Ref.	63268	 white blanco
Bulb	1xGU10 35W not incl. [LED 17316]	
Materials	Plaster Yeso	
V/Hz	100-240V / 50-60 Hz	
EEL	A++ to E	
Weight	0.43 kg / 0.95 lb	



+ info 

SVEN [new]**Ceiling Lamp**

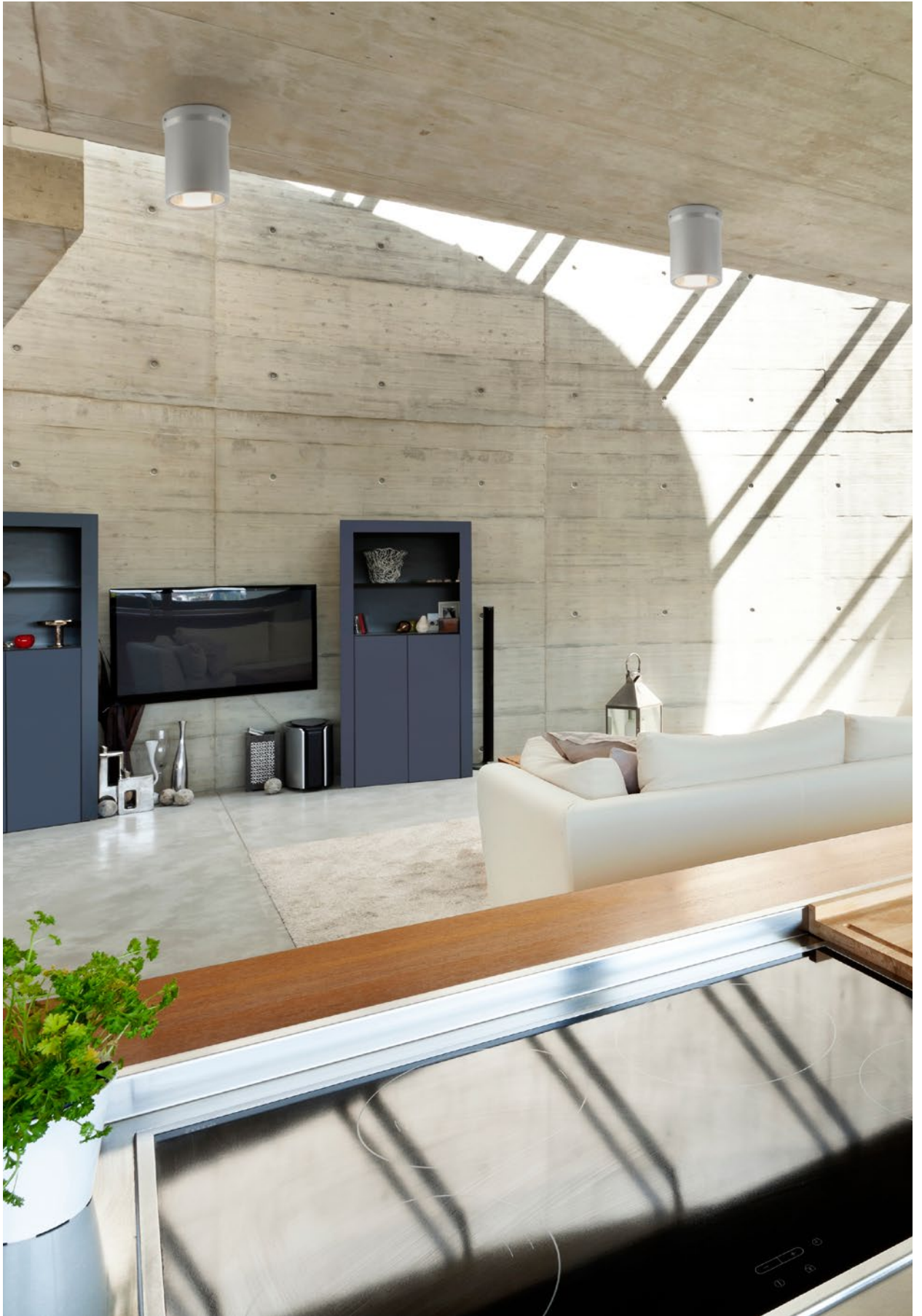
Ref.	63269	 white blanco
Bulb	1xGU10 35W not incl. [LED 17316]	
Materials	Plaster Yeso	
V/Hz	100-240V / 50-60 Hz	
EEL	A++ to E	
Weight	0.61 kg / 1.34 lb	

+ info 

**REL****Ceiling Lamp**

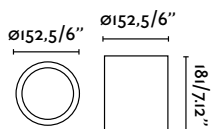
Ref.	64200	 white blanco	LED
	64201	 black negro	
Bulb	COB LED 25W 2700K 2230Lm CRI>80 incl.		
Materials	Aluminium + PMMA Aluminio + PMMA		
V/Hz	100-240V / 50-60 Hz		
Weight	1 kg / 2.20 lb		

+ info   



POTE

Ceiling Lamp



Ref.	63124		white blanco
	63125		black negro
	63126		grey gris

Bulb 1xE27 max 60W not incl. [LED 17453]

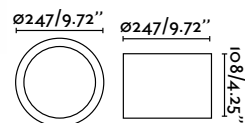
Materials Aluminium
Aluminio

V/Hz 100-240V / 50-60 Hz

EEL A++ to E

Weight 0.57 kg / 1.26 lb

+ info



POTE

Ceiling Lamp

Ref.	63127		white blanco	HF
	63128		black negro	HF
	63129		grey gris	HF

Bulb 2xE27 max 23W not incl. [16164]

Materials Aluminium
Aluminio

V/Hz 100-240V / 50-60 Hz

EEL A++ to B

Weight 0.57 kg / 1.26 lb

+ info



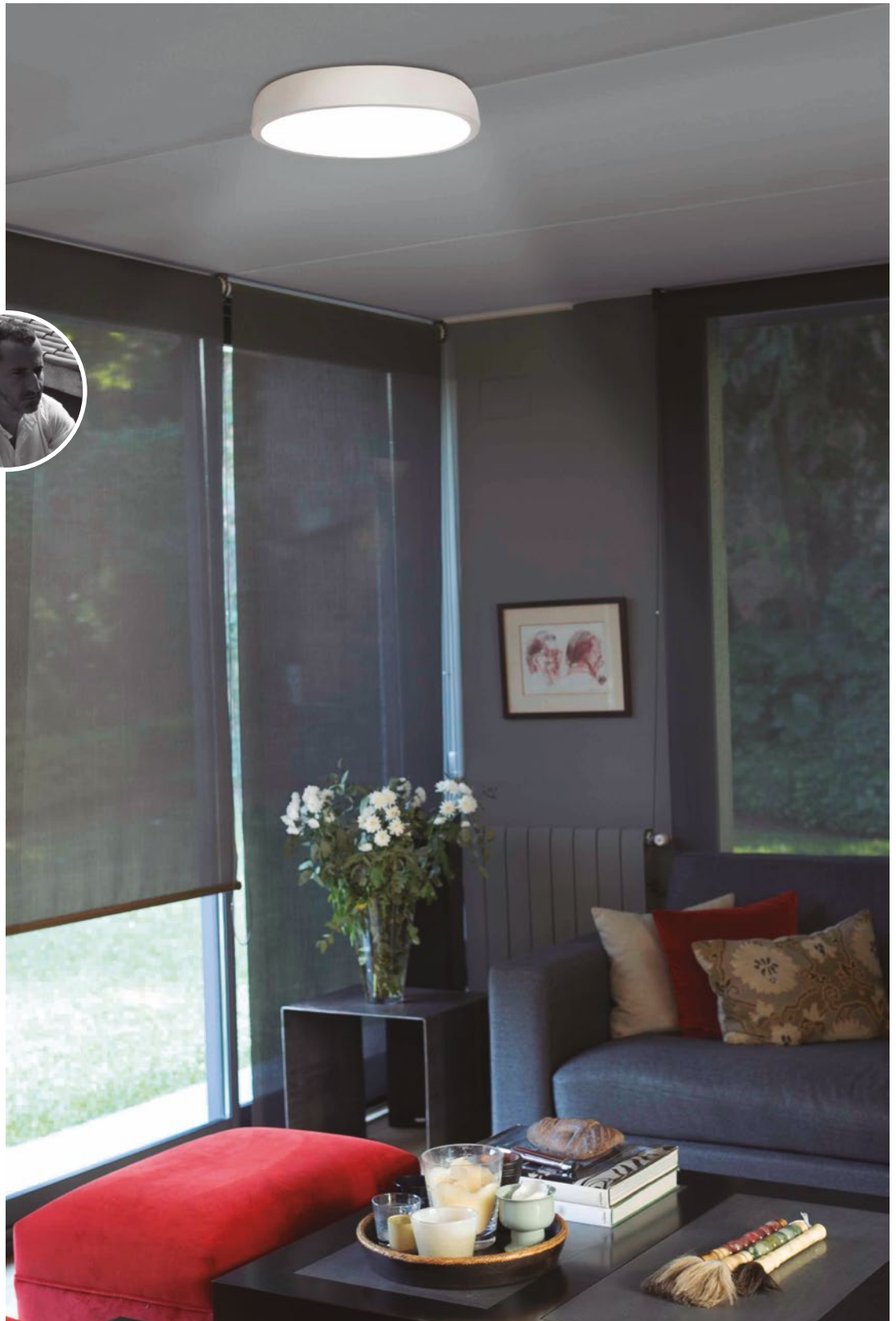
HF Until stock exhaustion
Hasta final de stock
Jusqu'à la fin de stock

Cocote

Design: Jordi Llopis

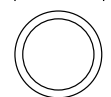


An elegant piece with character, while sober and timeless. Cocote is characterized by giving the same importance to the diffuser that projects light as to the metal mounting base.

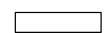








ø430/16.92"

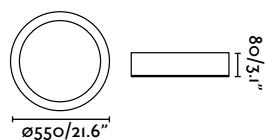


80/3.14"



Ceiling Lamp-p

Ref.	64180	 matt white blanco mate
	64181	 shiny black negro brillante
Bulb	1xT5 max 40W not incl. [9724040]	
Materials	Metal + Opal Acrylic Metal + Acrílico Opal	
V/Hz	220-240V / 50-60 Hz	
EEL	A to B	
Weight	1.97 kg / 4.34 lb	
+ info		BALLAST 







80/3.1\"/>

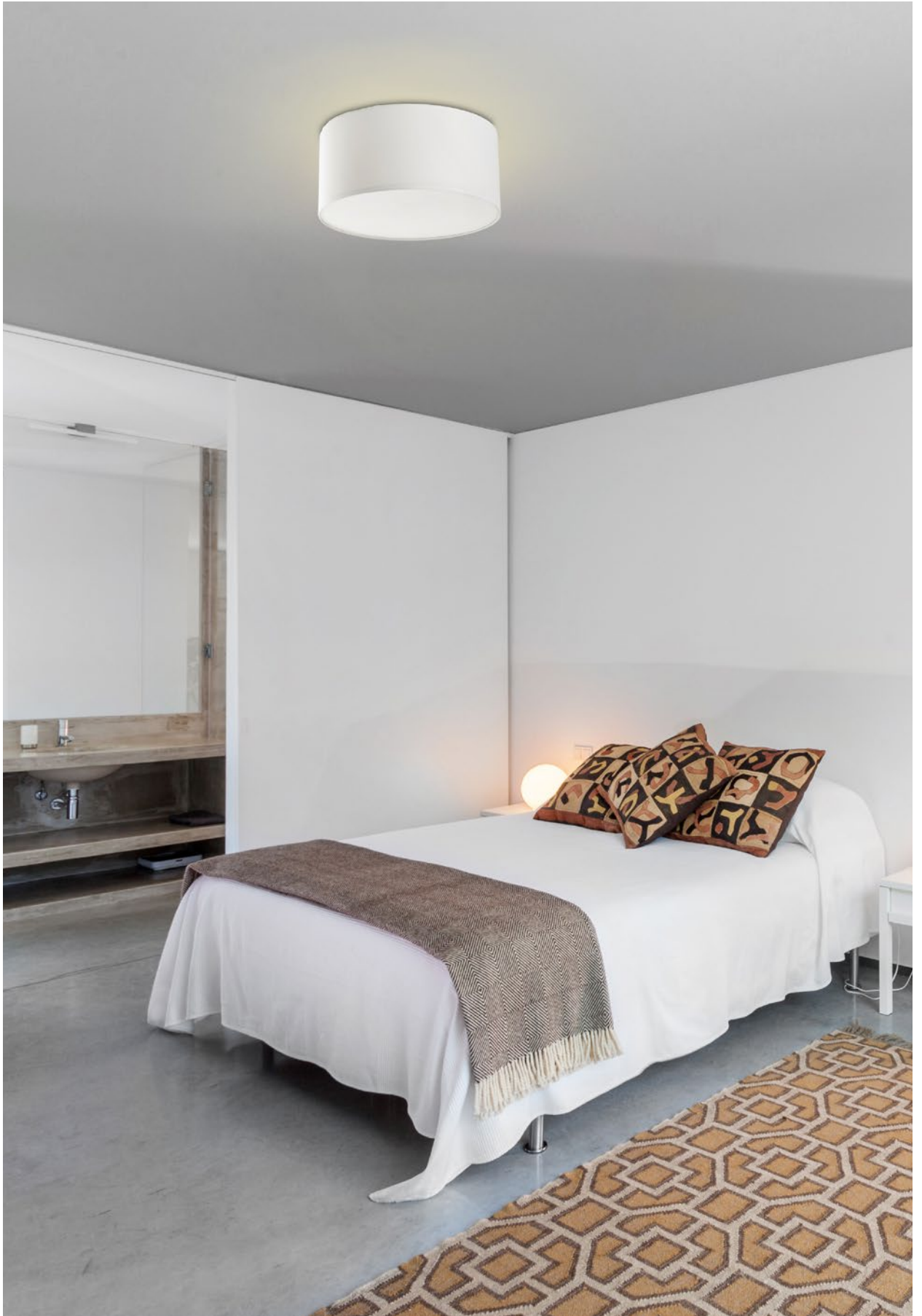
ø550/21.6\"/>

Ceiling Lamp-g

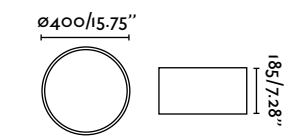
LED



Ref.	64182	 matt white blanco mate
	64183	 shiny black negro brillante
Bulb	SMD LED 42W 2700K 900Lm incl.	
Materials	Metal + Opal Acrylic Metal + Acrílico Opal	
V/Hz	100-240V / 50-60 Hz	
EEL	A	
Weight	2.81 kg / 6.19 lb	
+ info		DRIVER 

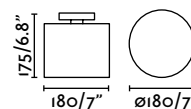










SEVEN [new]
Ceiling Lamp

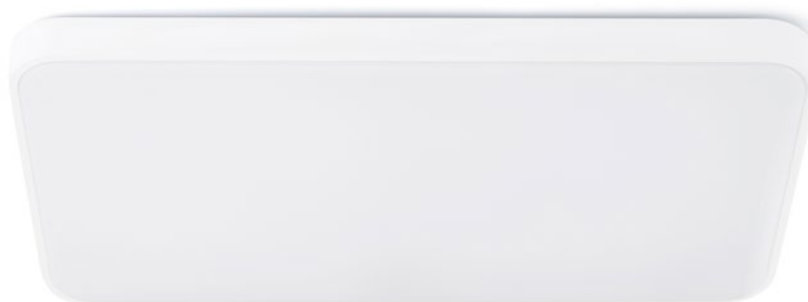


Ref.	68298	 white blanco
Bulb	2xE27 60W not incl. [LED 17453]	
Materials	Textile + Opal Acrylic Téxtil + Acrílico Opal	
V/Hz	100-240V / 50-60 Hz	
EEL	A++ to E	
Weight	1.09 kg / 2.40 lb	
+ info		

**JANET****Ceiling Lamp**

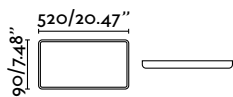
Ref.	65136	 	white+red blanco+rojo
	65137	 	white+gold blanco+oro
Bulb	1xE27 20W not incl. [LED 17056]		
Materials	Metal Metal		
V/Hz	100-240V / 50-60 Hz		
Weight	0.45 kg / 0.99 lb		
+ info	 		






SOGO [new]

Ceiling Lamp



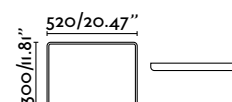
Ref.	62961		white blanco
Bulb	SMD LED 25W 4000K 2125Lm CRI>80 incl.		
Materials	Aluminium + Opal Polycarbonate Aluminio + Policarbonato Opal		
V/Hz	220-240V / 50-60 Hz		
EEL	A++ to A		
Weight	1 kg / 2.20 lb		


+ info

DRIVER 

SOGO [new]

Ceiling Lamp



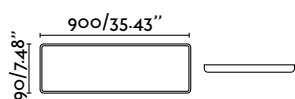
Ref.	62962		white blanco
Bulb	SMD LED 30W 4000K 2550Lm CRI>80 incl.		
Materials	Aluminium + Opal Polycarbonate Aluminio + Policarbonato Opal		
V/Hz	220-240V / 50-60 Hz		
EEL	A++ to A		
Weight	1.4 kg / 3.09 lb		


+ info

DRIVER 

SOGO [new]

Ceiling Lamp



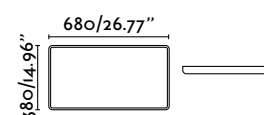
Ref.	62963		white blanco
Bulb	SMD LED 50W 4000K 4250Lm CRI>80 incl.		
Materials	Aluminium + Opal Polycarbonate Aluminio + Policarbonato Opal		
V/Hz	220-240V / 50-60 Hz		
EEL	A++ to A		
Weight	1.8 kg / 3.97 lb		


+ info

DRIVER 

SOGO [new]

Ceiling Lamp

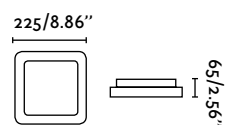
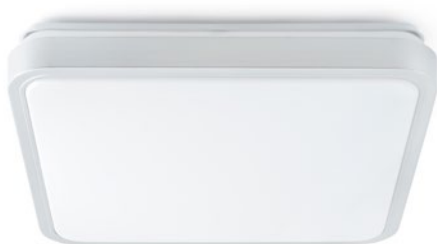


Ref.	62964		white blanco
Bulb	SMD LED 60W 4000K 5100Lm CRI>80 incl.		
Materials	Aluminium + Opal Polycarbonate Aluminio + Policarbonato Opal		
V/Hz	220-240V / 50-60 Hz		
EEL	A++ to A		
Weight	2 kg / 4.41 lb		

+ info

DRIVER 






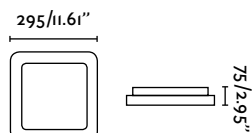
IRIS [new]

Ceiling
Lamp

LED

Ref.	63393	 grey gris
Bulb	SMD LED 15W 3000K 1200Lm CRI>80 incl.	
Materials	Aluminium + Opal PMMA Aluminio + PMMA Opal	
V/Hz	100-240V / 50-60 Hz	
EEL	A++ to A	
Weight	0.3 kg / 0.66 lb	


+ info

DRIVER 

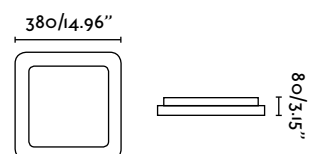
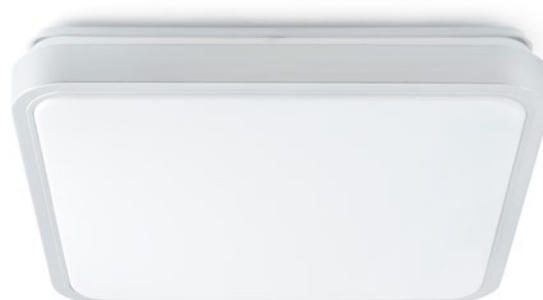
IRIS [new]

Ceiling
Lamp

LED

Ref.	63394	 grey gris
Bulb	SMD LED 20W 3000K 1600Lm CRI>80 incl.	
Materials	Aluminium + Opal PMMA Aluminio + PMMA Opal	
V/Hz	100-240V / 50-60 Hz	
EEL	A++ to A	
Weight	0.59 kg / 1.30 lb	


+ info

DRIVER 

IRIS [new]

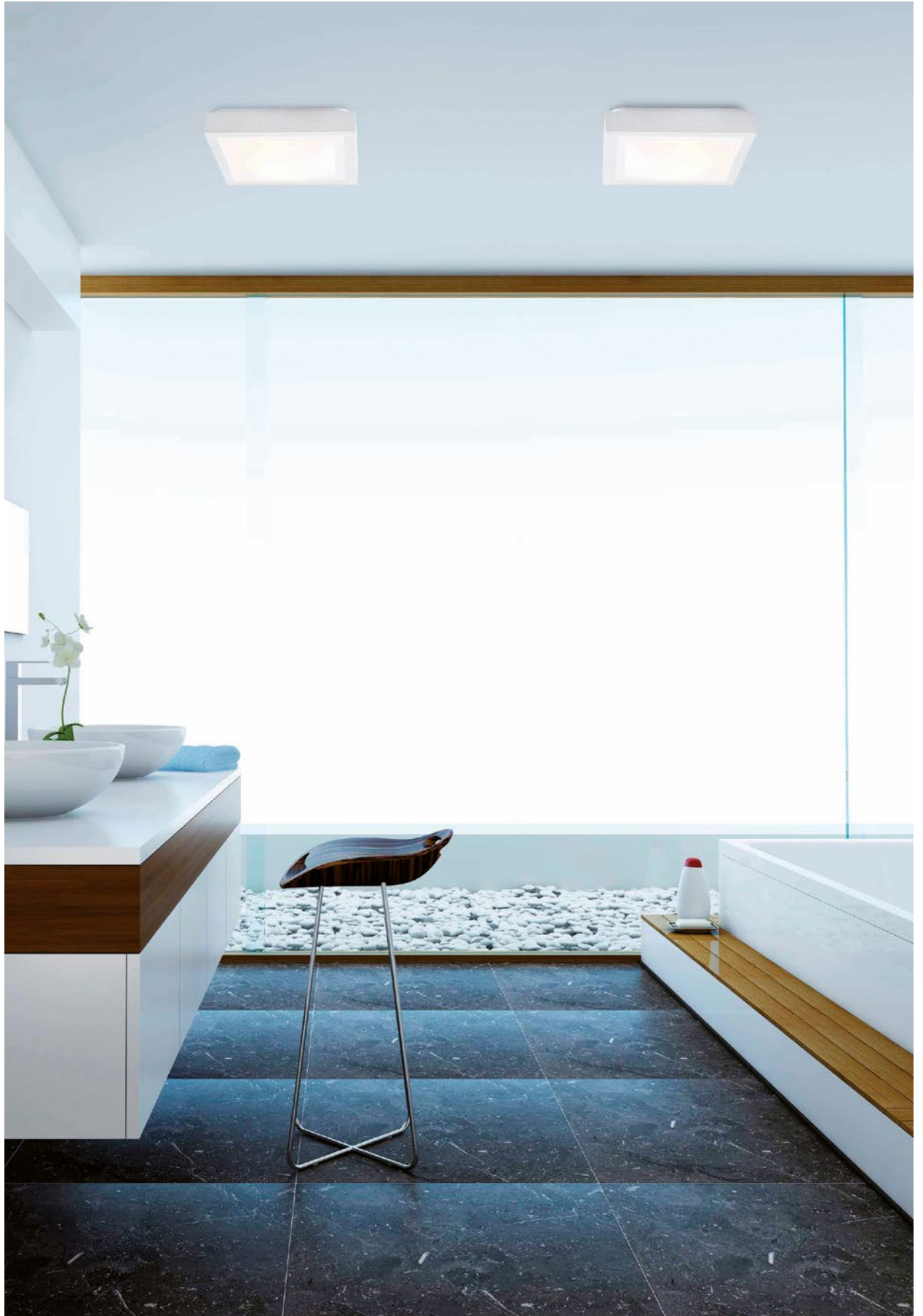
Ceiling
Lamp

LED

Ref.	63395	 grey gris
Bulb	SMD LED 30W 3000K 2400Lm CRI>80 incl.	
Materials	Aluminium + Opal PMMA Aluminio + PMMA Opal	
V/Hz	100-240V / 50-60 Hz	
EEL	A++ to A	
Weight	1.15 kg / 2.54 lb	

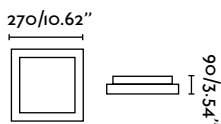
+ info

DRIVER 



TOLA

Ceiling Lamp



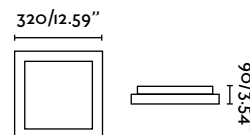
Ref.	62968		white blanco
	62983		polished aluminium aluminio pulido
Bulb	1xE27 20W not incl. [LED 17452]		
Materials	Aluminium + Opal Polycarbonate Aluminio + Policarbonato Opal		
V/Hz	100-240V / 50-60 Hz		
EEL	A++ to B		
Weight	1.3 kg / 2.87 lb		

+ info



TOLA

Ceiling Lamp



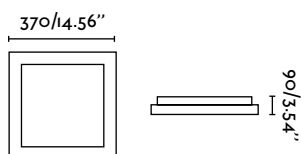
Ref.	62969		white blanco
	62984		polished aluminium aluminio pulido
Bulb	2xE27 20W not incl. [LED 17452]		
Materials	Aluminium + Opal Polycarbonate Aluminio + Policarbonato Opal		
V/Hz	100-240V / 50-60 Hz		
EEL	A++ to B		
Weight	1.6 kg / 3.53 lb		

+ info



TOLA

Ceiling Lamp

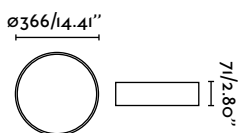


Ref.	62985		polished aluminium aluminio pulido
Bulb	3xE27 20W not incl. [LED 17452]		
Materials	Aluminium + Opal Polycarbonate Aluminio + Policarbonato Opal		
V/Hz	100-240V / 50-60 Hz		
EEL	A++ to B		
Weight	2.3 kg / 5.07 lb		


+ info





**VUK [new]****Ceiling Lamp**

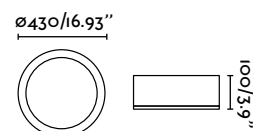
LED

Ref.	64188  white blanco
Bulb	SMD LED 40W 2700K 3000Lm CRI>80 incl.
Materials	Metal + Opal Polycarbonate Metal + Policarbonato Opal
V/Hz	220-240V / 50-60 Hz
EEL	A++ to A
Weight	1.47 kg / 3.24 lb


+ info



IP44

DRIVER **KAO****Ceiling Lamp**

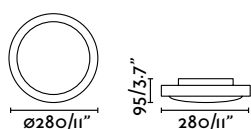
LED

Ref.	63399  chrome cromo
Bulb	SMD LED 35W 3000K 2800Lm CRI>80 incl.
Materials	Metal + Opal PMMA Metal + PMMA Opal
V/Hz	100-240V / 50-60 Hz
EEL	A++
Weight	1.02 kg / 2.25 lb

+ info



IP44

DRIVER **CLOE****Ceiling Lamp**

LED

Ref.	63403  chrome cromo
Bulb	SMD LED 24W 2700K 2000Lm CRI>80 incl.
Materials	Metal + Opal Glass Metal + Cristal Opal
V/Hz	100-240V / 50-60 Hz
EEL	A+
Weight	1.24 kg / 2.73 lb

+ info



IP44



DRIVER 



AMI

Ceiling Lamp

LED

Ref.	63397	 white blanco
	63398	 aluminium aluminio

Bulb SMD LED 15W 2700K | 200Lm CRI>80 incl.

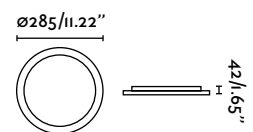
Materials Aluminium + PVC
Aluminio + PVC

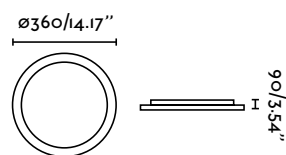
V/Hz 100-240V / 50-60 Hz

EEL A+

Weight 2.5 kg / 5.51 lb

+ info  





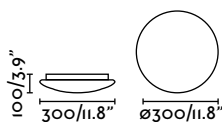
FORO [new]

Ceiling Lamp

LED IP44

Ref.	63404		white blanco
	63405		aluminium aluminio
Bulb	SMD LED 24W 3000K 2000Lm CRI>80 incl.		
Materials	Aluminium + Opal PMMA Aluminio + PMMA Opal		
V/Hz	220-240V / 50-60 Hz		
EEL	A++ to A		
Weight	3.5 kg / 7.72 lb		

+ info



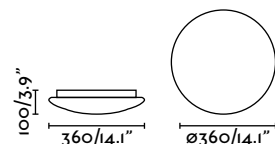
RONDA

Ceiling Lamp-p

LED

Ref.	63309		white blanco
Bulb	SMD LED 12W 4000K 900Lm CRI>80 incl.		
Materials	Aluminium + Acrylic Aluminio + Acrílico		
V/Hz	100-240V / 50-60 Hz		
EEL	A		
Weight	0.54 kg / 1.19 lb		

+ info



RONDA

Ceiling Lamp-g

LED

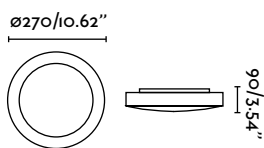
Ref.	63310		white blanco
Bulb	SMD LED 24W 4000K 1500Lm CRI>80 incl.		
Materials	Aluminium + Acrylic Aluminio + Acrílico		
V/Hz	100-240V / 50-60 Hz		
EEL	A		
Weight	0.8 kg / 1.76 lb		



+ info



LOGOS

Ceiling Lamp



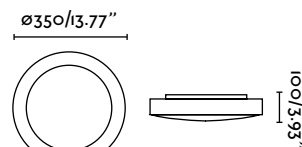
Ref.	62965		white blanco
	62980		polished aluminium aluminio pulido
Bulb	1xE27 20W not incl. [LED 17452]		
Materials	Aluminium + Opal Polycarbonate Aluminio + Policarbonato Opal		
V/Hz	100-240V / 50-60 Hz		
EEL	A++ to B		
Weight	1 kg / 2.20 lb		



+ info



LOGOS

Ceiling Lamp



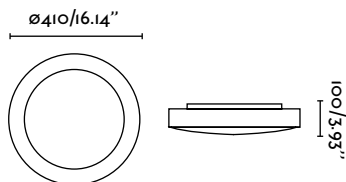
Ref.	62966		white blanco
	62981		polished aluminium aluminio pulido
Bulb	2xE27 20W not incl. [LED 17452]		
Materials	Acrylic + Opal Polycarbonate Acrílico + Policarbonato Opal		
V/Hz	100-240V / 50-60 Hz		
EEL	A++ to B		
Weight	1.5 kg / 3.31 lb		


+ info



LOGOS

Ceiling Lamp



Ref.	62982		polished aluminium aluminio pulido
Bulb	3xE27 20W not incl. [LED 17452]		
Materials	Acrylic + Opal Polycarbonate Acrílico + Policarbonato Opal		
V/Hz	100-240V / 50-60 Hz		
EEL	A++ to B		
Weight	1.7 kg / 3.75 lb		



+ info





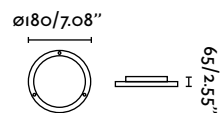
CORA


Ceiling Lamp

Ref.	63007	 	chrome+white cromo+blanco
Bulb	1xE27 60W not incl. [LED 17452]		
Materials	Aluminium + Metal + Opal Glass Aluminio + Metal + Cristal Opal		
V/Hz	100-240V / 50-60 Hz		
EEI	A++ to E		
Weight	1.3 kg / 2.87 lb		

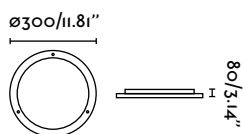
+ info




**YUCA****Ceiling Lamp-s**

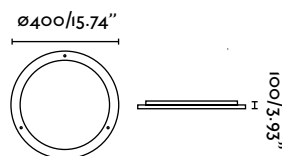
Ref.	63010	 matt nickel níquel mate
Bulb	1xG9 max 40W not incl. [I5615]	
Materials	Metal + Opal Glass Metal + Cristal Opal	
V/Hz	100-240V / 50-60 Hz	
EEI	A++ to E	
Weight	0.54 kg / 1.19 lb	


+ info

**YUCA****Ceiling Lamp-m**

Ref.	63011	 matt nickel níquel mate
Bulb	2xE27 max 40W not incl. [LED I7452]	
Materials	Metal + Opal Glass Metal + Cristal Opal	
V/Hz	100-240V / 50-60 Hz	
EEI	A++ to E	
Weight	1.3 kg / 2.87 lb	

+ info

**YUCA****Ceiling Lamp-l**

Ref.	63012	 matt nickel níquel mate
Bulb	2xE27 max 60W not incl. [LED I7452]	
Materials	Metal + Opal Glass Metal + Cristal Opal	
V/Hz	100-240V / 50-60 Hz	
EEI	A++ to E	
Weight	2.1 kg / 4.63 lb	

+ info




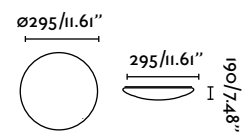


ADRA

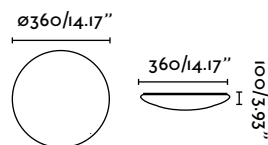
Ceiling Lamp-p


BULB INCLUDED
BOMBILLA INCLUIDA

Ref.	63075	 white blanco	HF
Bulb	1xG10Q 22W incl. [I5850]		
Materials	Steel + Opal Acrylic Acero + Acrílico Opal		
V/Hz	220-240V / 50-60 Hz		
EEL	A to B		
Weight	0.75 kg / 1.65 lb		

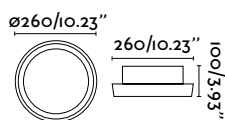




+ info  **BALLAST** 



**ADRA****Ceiling Lamp-g****BULB INCLUDED**
BOMBILLA INCLUIDA

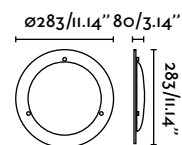
Ref.	63076	 white blanco	HF
Bulb	1 x G10Q 32W incl. [15850]		
Materials	Steel + Opal Acrylic Acero + Acrílico Opal		
V/Hz	220-240V / 50-60 Hz		
EEL	A to B		
Weight	1 kg / 2.20 lb		


+ info  **BALLAST** 

LENI**Ceiling Lamp**

Ref.	61005	 white blanco
	61006	 grey gris
Bulb	1 x E27 max 15W not incl. [LED 17452]	
Materials	PVC PVC	
V/Hz	100-240V / 50-60 Hz	
EEL	A++ to B	
Weight	0.6 kg / 1.32 lb	

+ info  

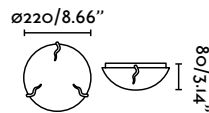
**VERA****Ceiling Lamp**

Ref.	63028	 grey gris
Bulb	1 x E27 max 60W not incl. [LED 17452]	
Materials	Steel + Opal Glass Acero + Cristal Opal	
V/Hz	100-240V / 50-60 Hz	
EEL	A++ to E	
Weight	0.72 kg / 1.59 lb	

+ info 


Sale: 10 units and multiples of 10
 Venta: 10 uds y múltiplos de 10
 Vente: 10 unités et multiples de 10
 Vendita: 10 unità e multipli di 10.

HF Until stock exhaustion
 Hasta final de stock
 Jusqu'à la fin de stock

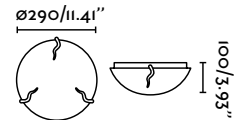


DATA

Ceiling Lamp-s


Ref.	63087  matt nickel níquel mate
Bulb	1xE27 max 60W not incl. [LED 17453]
Materials	Steel + Translucent Glass Acero + Cristal Translúcido
V/Hz	100-240V / 50-60 Hz
EEI	A++ to E
Weight	0.61 kg / 1.34 lb

+ info 

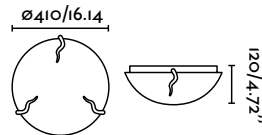


DATA

Ceiling Lamp-m


Ref.	63088  matt nickel níquel mate
Bulb	2xE27 max 60W not incl. [LED 17453]
Materials	Steel + Translucent Glass Acero + Cristal Translúcido
V/Hz	100-240V / 50-60 Hz
EEI	A++ to E
Weight	1.2 kg / 2.65 lb

+ info 

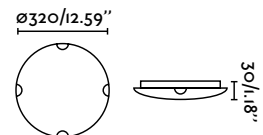


DATA

Ceiling Lamp-l


Ref.	63089  matt nickel níquel mate
Bulb	2xE14 max 60W not incl. [LED 17451]
Materials	Steel + Translucent Glass Acero + Cristal Translúcido
V/Hz	100-240V / 50-60 Hz
EEI	A++ to E
Weight	2 kg / 4.41 lb

+ info 



DANTE

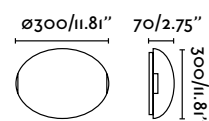
Ceiling Lamp


Ref.	61008  chrome cromo
Bulb	1xE27 max 60W not incl. [LED 17453]
Materials	Steel + Translucent Glass Acero + Cristal Translúcido
V/Hz	100-240V / 50-60 Hz
EEI	A++ to E
Weight	0.97 kg / 2.14 lb

+ info 

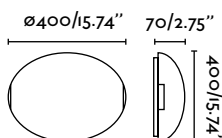
HF


HF Until stock exhaustion
Hasta final de stock
Jusqu'à la fin de stock

**DINO****Ceiling Lamp-s**

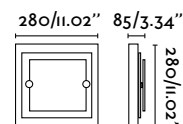
Ref.	63056  matt nickel níquel mate
Bulb	1xE27 max 60W not incl. [LED 17452]
Materials	Metal + Opal Glass Metal + Cristal Opal
V/Hz	100-240V / 50-60 Hz
EEL	A++ to E
Weight	1.3 kg / 2.87 lb


+ info 

**DINO****Ceiling Lamp-l**

Ref.	63057  matt nickel níquel mate
Bulb	2xE27 max 60W not incl. [LED 17452]
Materials	Metal + Opal Glass Metal + Cristal Opal
V/Hz	100-240V / 50-60 Hz
EEL	A++ to E
Weight	2.23 kg / 4.92 lb

+ info 

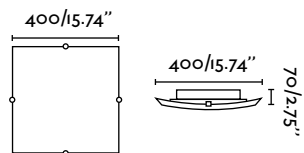
**ACACIA****Ceiling Lamp**

Ref.	63084  matt nickel níquel mate	HF
Bulb	2xE27 max 60W not incl. [LED 17452]	
Materials	Glass Cristal	
V/Hz	100-240V / 50-60 Hz	
EEL	A++ to E	
Weight	1.99 kg / 4.39 lb	

+ info 


HF Until stock exhaustion
Hasta final de stock
Jusqu'à la fin de stock



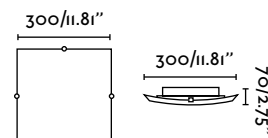


LIRIA

Ceiling Lamp


Ref.	63158	 matt nickel níquel mate
Bulb	2xE27 max 60W not incl. [LED I7452]	
Materials	Metal + Translucent Glass Metal + Cristal Translúcido	
V/Hz	100-240V / 50-60 Hz	
EEL	A++ to E	
Weight	2.06 kg / 4.54 lb	

+ info



LIRIA

Ceiling Lamp

Ref.	63157	 matt nickel níquel mate
Bulb	2xE27 max 60W not incl. [LED I7452]	
Materials	Metal + Translucent Glass Metal + Cristal Translúcido	
V/Hz	100-240V / 50-60 Hz	
EEL	A++ to E	
Weight	1.3 kg / 2.87 lb	

+ info











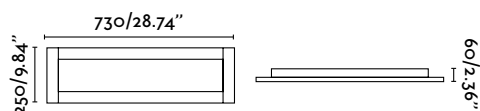
AZOR

Ceiling Lamp

BULB INCLUDED
BOMBILLA INCLUIDA

Ref.	03009			chrome+matt nickel cromo+níquel mate
	03010			chrome+dark brown cromo+marrón oscuro
Bulb	2x2G II 55W incl. [15925]			
Materials	Metal + Opal Polycarbonate Metal + Policarbonato Opal			
V/Hz	220-240V / 50-60 Hz			
EEI	A to B			
Weight	3.53 kg / 7.78 lb			

HF







+ info



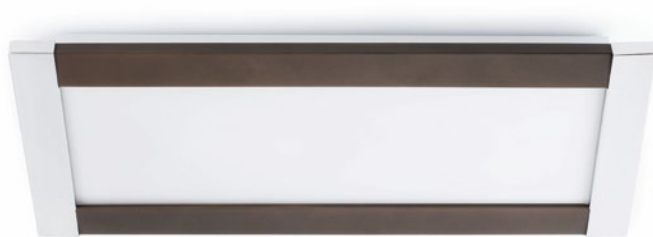
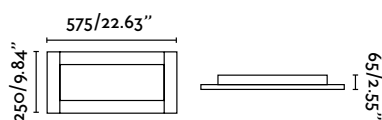
AZOR

Ceiling Lamp

BULB INCLUDED
BOMBILLA INCLUIDA

Ref.	03007			chrome+matt nickel cromo+níquel mate
	03008			chrome+dark brown cromo+marrón oscuro
Bulb	2x2G II 36W incl. [15923]			
Materials	Metal + Opal Polycarbonate Metal + Policarbonato Opal			
V/Hz	220-240V / 50-60 Hz			
EEI	A to B			
Weight	2.93 kg / 6.46 lb			

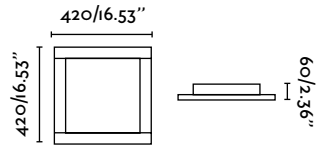
HF





HF Until stock exhaustion
Hasta final de stock
Jusqu'à la fin de stock

AZOR

Ceiling Lamp

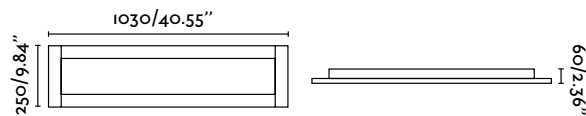


Ref.	03015		chrome+matt nickel cromo+níquel mate
	03016		chrome+dark brown cromo+marrón oscuro
Bulb	1xG10Q G10Q 22W not incl. [15850] + 1xT5 G10q 32W not incl. [15852]		
Materials	Metal + Opal Polycarbonate Metal + Policarbonato Opal		
V/Hz	220-240V / 50-60 Hz		
EEL	A to B		
Weight	3.15 kg / 6.94 lb		

+ info





HF



AZOR

Ceiling Lamp

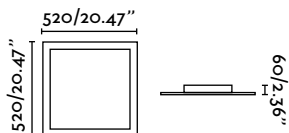
BULB INCLUDED
BOMBILLA INCLUIDA

Ref.	03011		chrome+matt nickel cromo+níquel mate
	03012		chrome+dark brown cromo+marrón oscuro
Bulb	4x2G11 36W incl. [15923]		
Materials	Metal + Opal Polycarbonate Metal + Policarbonato Opal		
V/Hz	220-240V / 50-60 Hz		
EEL	A to B		
Weight	4.78 kg / 10.54 lb		

+ info

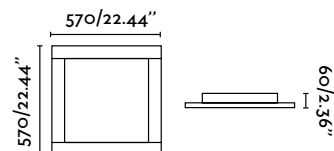
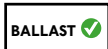


HF

**AZOR****Ceiling Lamp****BULB INCLUDED**
BOMBILLA INCLUIDA

Ref.	03006	matt nickel níquel mate
Bulb	3x2G II 24W incl.	
Materials	Steel + Opal PVC Acero + PVC Opal	
V/Hz	220-240V / 50-60 Hz	
EEl	A to B	
Weight	4.8 kg / 10.58 lb	

+ info

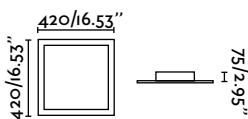
**AZOR****Ceiling Lamp****BULB INCLUDED**
BOMBILLA INCLUIDA

Ref.	03013	chrome+matt nickel cromo+níquel mate
	03014	chrome+dark brown cromo+marrón oscuro
Bulb	3x2G II 36W incl.	
Materials	Metal + Opal Polycarbonate Metal + Policarbonato Opal	
V/Hz	220-240V / 50-60 Hz	
EEl	A to B	
Weight	5.7 kg / 12.57 lb	

+ info



HF

**AZOR****Ceiling Lamp**

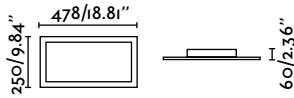
Ref.	03005	matt nickel níquel mate
Bulb	1xT9 G10q 32W not incl. + 1xT9 G10q 22W not incl.	
Materials	Steel + Opal PVC Acero + PVC Opal	
V/Hz	220-240V / 50-60 Hz	
EEl	A to B	
Weight	3 kg / 6.61 lb	

+ info



HF


Until stock exhaustion
Hasta final de stock
Jusqu'à la fin de stock



AZOR

Ceiling Lamp

BULB INCLUDED
BOMBILLA INCLUIDA

Ref.	03002  matt nickel níquel mate
Bulb	2x2G11 24W incl.
Materials	Steel + Opal PVC Acero + PVC Opal
V/Hz	220-240V / 50-60 Hz
EEL	A to B
Weight	2.4 kg / 5.29 lb


+ info



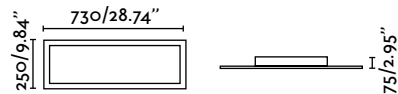
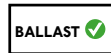
AZOR

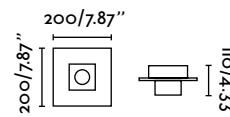
Ceiling Lamp

BULB INCLUDED
BOMBILLA INCLUIDA

Ref.	03004  matt nickel níquel mate
Bulb	2x2G11 55W incl.
Materials	Steel + Opal PVC Acero + PVC Opal
V/Hz	220-240V / 50-60 Hz
EEL	A to B
Weight	3.5 kg / 7.72 lb

+ info





KALO

Ceiling Lamp



**DUAL FUNCTION G9/LED
FUNCIÓN DUAL G9/LED**

Ref.	67000	 transparent transparente	HF
Bulb	1 x G9 40W incl. + LED RGB 0,84W incl.		
Materials	Metal + Transparent Glass Metal + Cristal Transparente		
V/Hz	220-240V / 50-60 Hz		
EEl	A++ to D		
Weight	2.2 kg / 4.85 lb		

+ info   

KALO

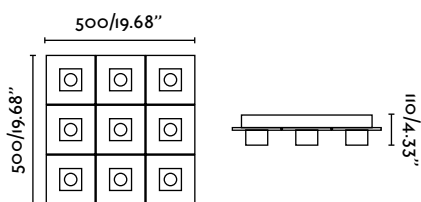
Ceiling Lamp



**DUAL FUNCTION G9/LED
FUNCIÓN DUAL G9/LED**

Ref.	67002	 transparent transparente	HF
Bulb	9 x G9 40W incl. + LED RGB 7,56W incl.		
Materials	Metal + Transparent Glass Metal + Cristal Transparente		
V/Hz	220-240V / 50-60 Hz		
EEl	A++ to D		
Weight	14 kg / 30.86 lb		

+ info   



HF **Until stock exhaustion**
Hasta final de stock
Jusqu'à la fin de stock



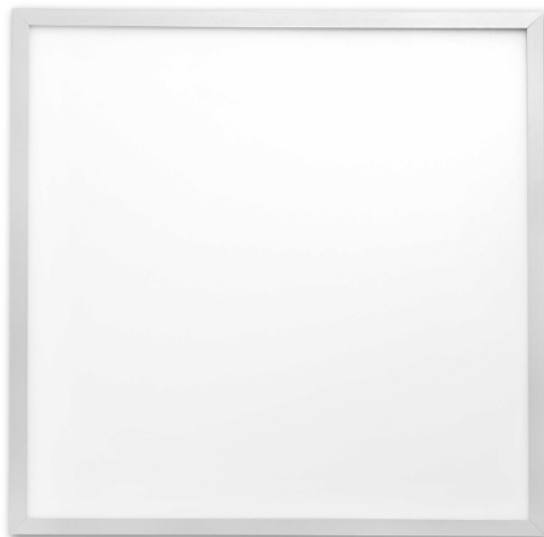
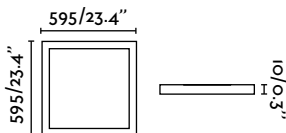
Argón	339	Ónice	342
Dana	327	Plano	340
Dot	323	Plas	333
Ebba	327	Quark	347
Fijo	347	Radón	337
Flat	319	Son	322
Gingko	344	Ted	325
Kant	327	Tirso	335
Koi	329	Tod	325
Led Mini	329	Yes	331
Malmo	330	Zircón	343
Mont	321		
Móvil	347		
Neón	339		
Neu	331		
Neutrón	342		
Nord	331		
Nusa	323		





FLAT

Recessed



Ref.	42840		aluminium aluminio	2700K	3100Lm
	42841		aluminium aluminio	4000K	3200Lm
Bulb	SMD LED 48W incl. Driver I 400mA incl.				
Materials	Aluminium + PMMA Aluminio + PMMA				
V/Hz	100-240V / 50-60 Hz				
EEL	A++				
Weight	4.1 kg / 9.04 lb				

+ info



DRIVER



Driver DALI
98310589

Driver I-10V
98310689

Kit Suspension Flat
Kit Suspensión Flat

42842

4 Tensors incl.
4 Tensores incl.

Steel
Acero

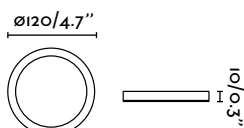






MONT

**Recessed
6W**



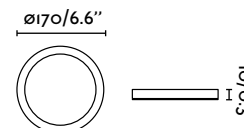
Ref.	42862		white blanco	3000K	380Lm	
	42863		white blanco	6000K	400Lm	HF
	42865		grey gris	6000K	400Lm	HF
	42878		white blanco	4000K	390Lm	[new]

Bulb	SMD LED 6W incl.
Materials	Metal + Polycarbonate Metal + Policarbonato
V/Hz	100-240V / 50-60 Hz
EEL	A+
Weight	0.3 kg / 0.66 lb

+ info

MONT

**Recessed
12W**



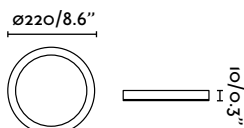
Ref.	42866		white blanco	3000K	850Lm	
	42867		white blanco	6000K	890Lm	HF
	42868		grey gris	3000K	850Lm	HF
	42879		white blanco	4000K	870Lm	[new]

Bulb	SMD LED 12W incl.
Materials	Metal + Polycarbonate Metal + Policarbonato
V/Hz	100-240V / 50-60 Hz
EEL	A+
Weight	0.35 kg / 0.77 lb

+ info

MONT

**Recessed
18W**



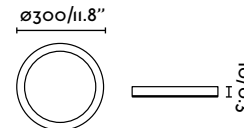
Ref.	42870		white blanco	3000K	1200Lm	
	42871		white blanco	6000K	1250Lm	HF
	42872		grey gris	3000K	1200Lm	
	42880		white blanco	4000K	1230Lm	[new]

Bulb	SMD LED 18W incl.
Materials	Metal + Polycarbonate Metal + Policarbonato
V/Hz	100-240V / 50-60 Hz
EEL	A+
Weight	0.4 kg / 0.88 lb

+ info

MONT

**Recessed
25W**



Ref.	42874		white blanco	3000K	1900Lm	HF
	42875		white blanco	6000K	1990Lm	HF
	42876		grey gris	3000K	1900Lm	HF

Bulb	SMD LED 25W incl.
Materials	Metal + Polycarbonate Metal + Policarbonato
V/Hz	100-240V / 50-60 Hz
EEL	A+
Weight	0.44 kg / 0.97 lb


+ info



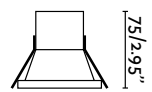
SON -I [new]

LED

Recessed

Ref.	42928	 white blanco
Bulb	SMD LED 8W 2700K 580Lm CRI>80 incl.	
Materials	Aluminium + PMMA Aluminio + PMMA	
V/Hz	220-240V / 50-60 Hz	
EEL	A++ to A	
Weight	0.25 kg / 0.55 lb	

Ø112/4.41"

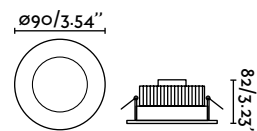




+ info



DRIVER 





**NUSA****Recessed**

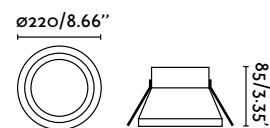
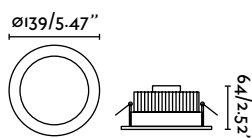
Ref.	02090101		white blanco	2700K
	02090201		white blanco	4000K
Bulb	COB LED 7W 550Lm incl.			
Materials	Aluminium Aluminio			
V/Hz	100-240V / 50-60 Hz			
Weight	0.3 kg / 0.66 lb			



+ info

**DOT****Recessed**

Ref.	42923		white blanco	3000K
	42924		white blanco	5000K
Bulb	SMD LED 24W 2400Lm incl.			
Materials	Aluminium + Opal PMMA Aluminio + PMMA Opal			
V/Hz	100-240V / 50-60 Hz			
EEL	A++ to A			
Weight	0.6 kg / 1.32 lb			

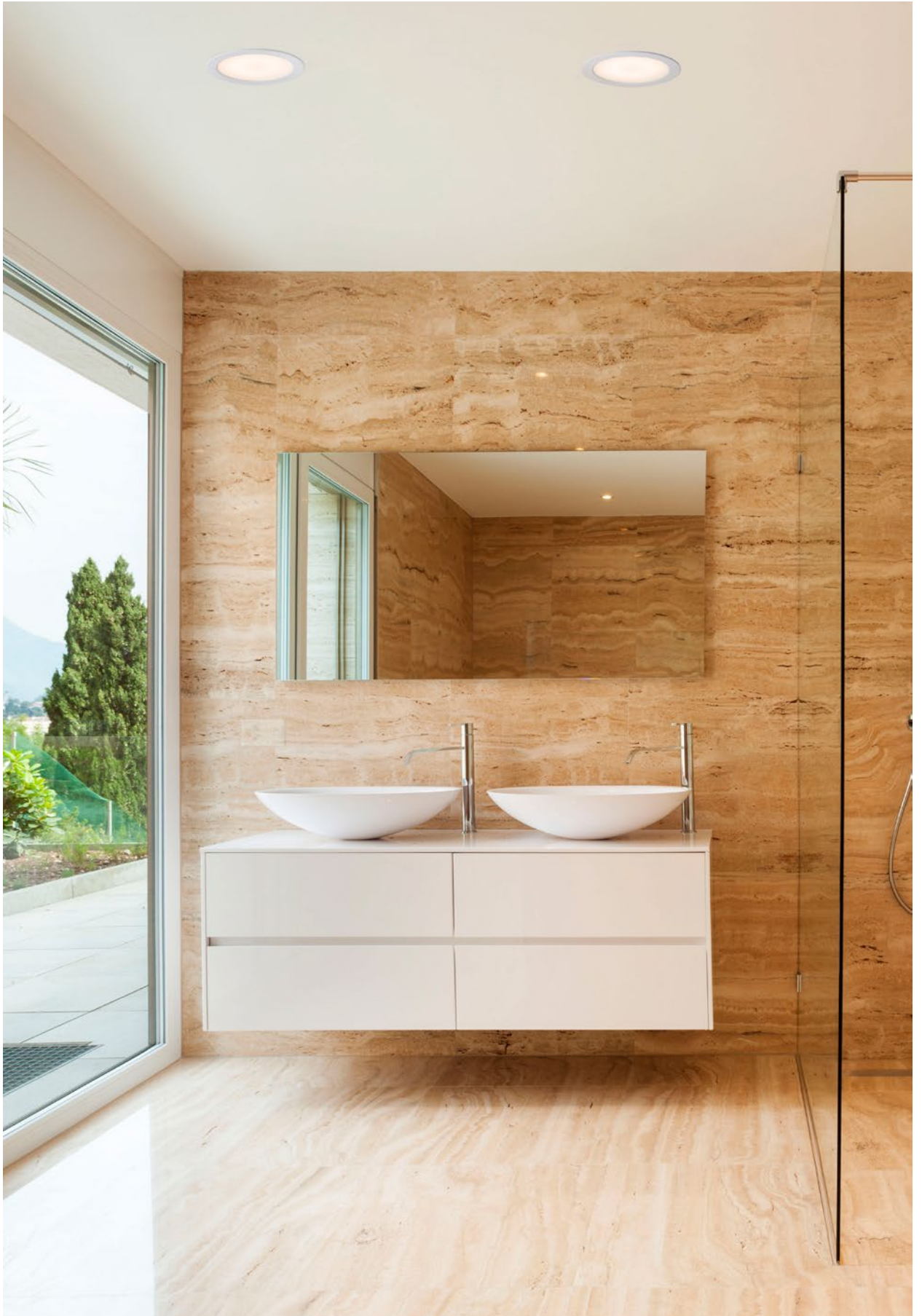
+ info

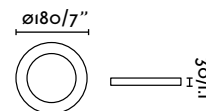
**SON-2 [new]****LED****Recessed**

Ref.	42929		white blanco	2700K	2000Lm
	42930		white blanco	4000K	2100Lm
Bulb	SMD LED 24W CRI>80 incl.				
Materials	Aluminium + PMMA Aluminio + PMMA				
V/Hz	220-240V / 50-60 Hz				
EEL	A++ to A				
Weight	0.53 kg / 1.17 lb				

+ info











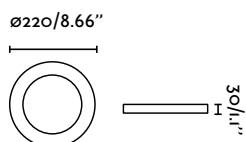


TED

Recessed


Ref.	42926	 white blanco
Bulb	SMD LED 15W 3000K 1200Lm CRI>80 incl.	
Materials	Aluminium + PMMA Aluminio + PMMA	
V/Hz	220-240V / 50-60 Hz	
EEL	A+	
Weight	0.28 kg / 0.62 lb	

+ info     



TOD

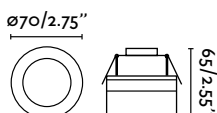
Recessed



Ref.	42927	 white blanco
Bulb	SMD LED 24W 3000K 2000Lm CRI>80 incl.	
Materials	Aluminium + PMMA Aluminio + PMMA	
V/Hz	220-240V / 50-60 Hz	
EEL	A+	
Weight	0.41 kg / 0.90 lb	

+ info     

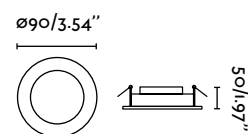





**EBBA****Recessed****LED**

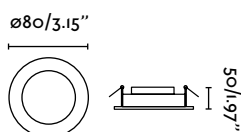
Ref.	42919   transparent+silver transparente+plata
Bulb	SMD LED 4W 3000K 304Lm incl.
Materials	Aluminium + Transparent PMMA + Opal PMMA Aluminio + PMMA Transparente + PMMA Opal
V/Hz	100-240V / 50-60 Hz
EEL	A++
Weight	0.3 kg / 0.66 lb



+ info

**DANA****Recessed****LED**

Ref.	42925  white blanco
Bulb	SMD LED 12W 5000K 900Lm incl.
Materials	Aluminium + Opal PMMA Aluminio + PMMA Opal
V/Hz	100-240V / 50-60 Hz
EEL	A++ to A
Weight	0.3 kg / 0.66 lb

+ info

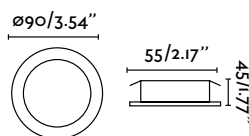
**KANT****Recessed****IP65**

Ref.	40215  grey gris
	40225  white blanco
Bulb	1xMR16 50W not incl. [LED I 41 42] Gear not incl. [43070]. LED [98101050] Socket incl. / Portalámparas incl.
Materials	Die Cast Aluminium + Translucent Glass Aluminio Inyectado + Cristal Translúcido
V/Hz	12V
EEL	A++ to E
Weight	0.19 kg / 0.42 lb

+ info








KOI



Recessed

Ref.	42921	 white blanco
Bulb	SMD LED 6W 3000K 400Lm incl.	
Materials	PVC + Polycarbonate PVC + Policarbonato	
V/Hz	100-240V / 50-60 Hz	
EEl	A	
Weight	0.2 kg / 0.44 lb	

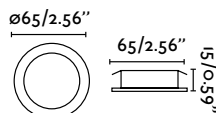
+ info    

LED MINI



Recessed

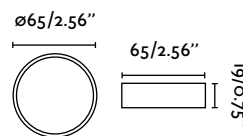
Ref.	42910	 white blanco
	42911	 chrome cromo
Bulb	HIGH POWER LED 3,5W 3000K 200Lm incl. Driver not incl. [98310110]	
Materials	Metal + Translucent Polycarbonate Metal + Policarbonato Translúcido	
V/Hz	220-240V / 50 Hz	
EEl	A++	
Weight	0.1 kg / 0.22 lb	

+ info   



Accessory not incl.
Accesorio no incl.

42912	 white blanco
42913	 chrome cromo
Aluminium Aluminio	
0.04 kg / 0.09 lb	






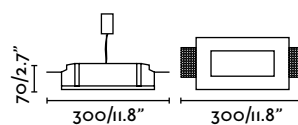
MALMO

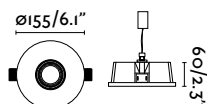
PLASTER **LED**
YESO

Recessed

Ref.	63289	 white blanco
Bulb	SMD LED 9W 3000K 360Lm incl. Driver DC 500mA not incl. [98310316]	
Materials	Plaster Yeso	
V/Hz	220-240V / 50-60 Hz	
EEl	A	
Weight	2.28 kg / 5.03 lb	

+ info




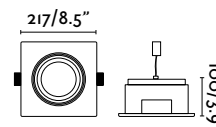


NEU

Recessed

PLASTER YESO


Ref.	63286  white blanco
Bulb	1xMR16 35W not incl. [LED 17326] Gear not incl. [98101050]
Materials	Plaster Yeso
V/Hz	220-240V / 50-60 Hz
EEL	A++ to E
Weight	0.9 kg / 1.98 lb

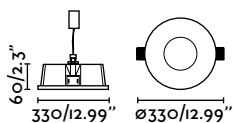


YES

Recessed

PLASTER YESO


Ref.	63280  white blanco
Bulb	1xAR111 max 100W not incl. [LED 17512] Gear not incl. [98101050]
Materials	Plaster + Aluminium Yeso + Aluminio
V/Hz	220-240V / 50-60 Hz
EEL	A++ to E
Weight	1.8 kg / 3.97 lb



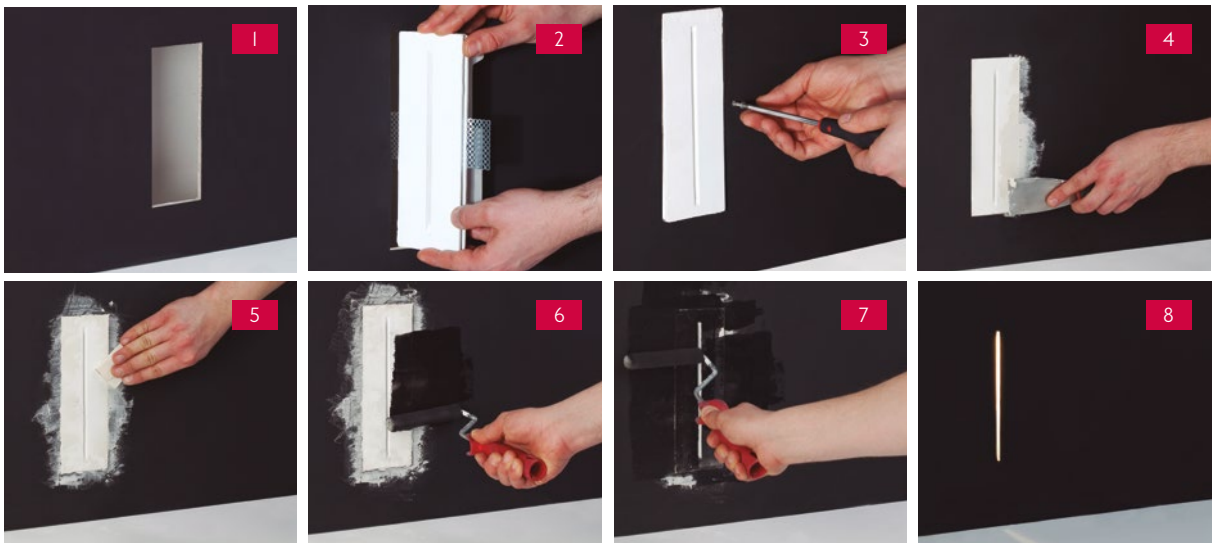
NORD

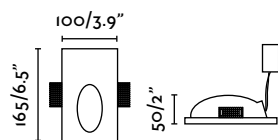
Recessed

PLASTER YESO LED

Ref.	63290  white blanco
Bulb	SMD LED 18W 3000k 630Lm incl. Driver DC 350mA not incl. [98310125]
Materials	Plaster Yeso
V/Hz	32V / 50-60 Hz
EEL	A
Weight	0.76 kg / 1.68 lb






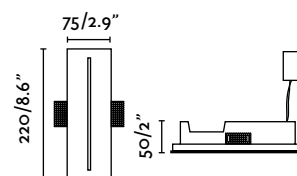


PLAS

Recessed

PLASTER YESO LED


Ref.	63281	 white blanco
Bulb	HIGH POWER LED 1W 3000K II 2Lm incl. Driver not incl. 350mA (46060)	
Materials	Plaster Yeso	
V/Hz	220-240V / 50-60 Hz	
EEL	A++	
Weight	0.6 kg / 1.32 lb	

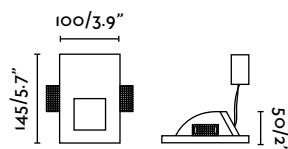


PLAS

Recessed

PLASTER YESO LED


Ref.	63282	 white blanco
Bulb	HIGH POWER LED 1W 3000K II 2Lm incl. Driver not incl. 350mA (46060)	
Materials	Plaster Yeso	
V/Hz	220-240V / 50-60 Hz	
EEL	A++	
Weight	0.7 kg / 1.54 lb	



PLAS

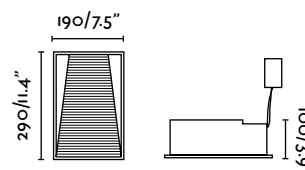
Recessed


PLASTER YESO LED

Ref.	63283	 white blanco
Bulb	HIGH POWER LED 1W 3000K II 2Lm incl. Driver not incl. 350mA (46060)	
Materials	Plaster Yeso	
V/Hz	220-240V / 50-60 Hz	
EEL	A++	
Weight	0.57 kg / 1.26 lb	

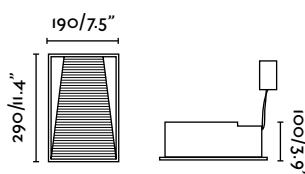
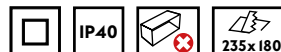





**TIRSO R7S****Recessed**

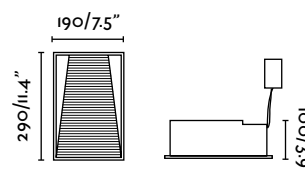
Ref.	46029  grey gris	HF
Bulb	1xR7s JP 118mm max 100W not incl. [17602]	
Materials	Aluminium + Acrylic Aluminio + Acrílico	
V/Hz	220-240V / 50-60 Hz	
EEL	A++ to E	
Weight	1.1 kg / 2.43 lb	


+ info

**TIRSO G24 d-I****Recessed**

Ref.	46030  grey gris	HF
Bulb	1xG24 d-I 13W not incl. [15903]	
Materials	Aluminium + Acrylic Aluminio + Acrílico	
V/Hz	220-240V / 50-60 Hz	
EEL	A++ to B	
Weight	1.37 kg / 3.02 lb	

+ info

**TIRSO LED****Recessed**

Ref.	46027  grey gris	HF
Bulb	COB LED 3W 4200K 130Lm incl.	
Materials	Aluminium + Acrylic Aluminio + Acrílico	
V/Hz	220-240V / 50-60 Hz	
EEL	A++	
Weight	1.2 kg / 2.65 lb	

+ info



HF Until stock exhaustion
Hasta final de stock
Jusqu'à la fin de stock



STRUCTURE
ESTRUCTURA



LED BULB
BOMBILLA LED
MRI6/GUIO



HALOGEN LAMP
LAMPARA HALÓGENA
MRI6/GUIO



LED MODULE
MÓDULO LED
17500/17501



COB LED Module 8W
Módulo COB LED 8W

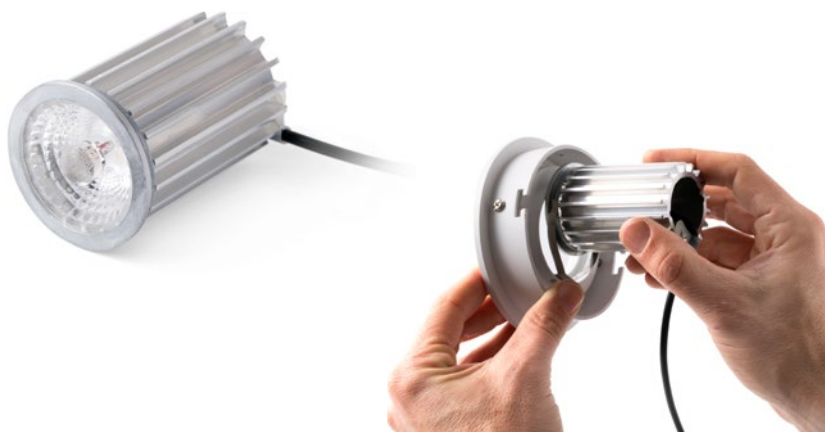
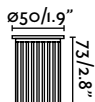
17500 2700K

550Lm 8W CRI>80

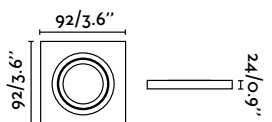
Metal + Glass
Metal + Cristal

100-240V

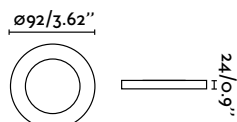
A+



REF. 43396



REF. 43398



RADÓN

ORIENTABLE HALOGEN/LED

Recessed

Ref. 43396 white
blanco

43398 white
blanco

1xMR 16 50W not incl. [LED 17326]
Transformer not incl. LED [98111050]
Socket / Portalámparas MR 16 4R033 not incl.

Bulb Or 1xGU 10 50W not incl. [LED 17316]
Socket / Portalámparas GU 10 43065 not incl.

Or Module COB LED 8w 2700k not incl. [17500]
Driver incl.

Materials Aluminium
Aluminio

Weight 0.13 kg / 0.29 lb

+ info

RADÓN

HALOGEN/LED ORIENTABLE

Recessed

Ref. 43397 white
blanco

2xMR 16 50W not incl. [LED 17326]
Transformer not incl. LED [98111050]
Socket / Portalámparas MR 16 4R033 not incl.

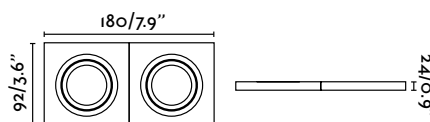
Bulb Or 2xGU 10 50W not incl. [LED 17316]
Socket / Portalámparas GU 10 43065 not incl.

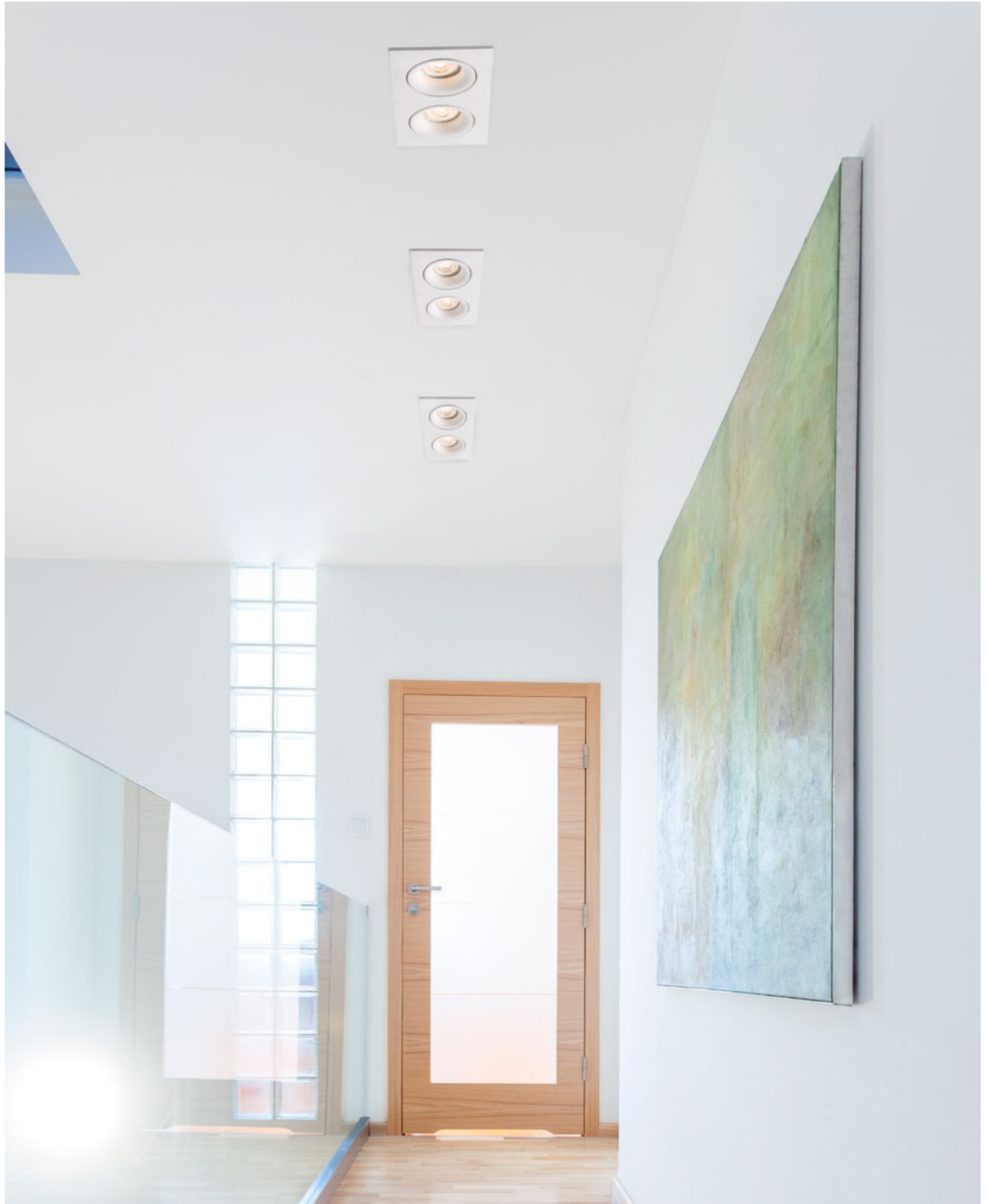
Or Module COB LED 8w 2700k not incl. [17500]
Driver incl.

Materials Aluminium
Aluminio

Weight 0.26 kg / 0.57 lb

+ info





STRUCTURE
ESTRUCTURA



LED BULB
BOMBILLA LED
MRI6/GUIO



HALOGEN LAMP
LAMPARA HALÓGENA
MRI6/GUIO




LED MODULE
MÓDULO LED
I7500/I7501




ARGÓN

Recessed

ORIENTABLE HALOGEN/LED

Ref. **43401**  white
blanco

Ref. **43402**  white
blanco




1xMR 16 50W incl. [LED 17326]
Transformer not incl. LED [98111050]
Socket / Portalámparas MR 16 4R033 not incl.

Bulb Or 1xGU 10 50W not incl. [LED 17316]
Socket / Portalámparas GU 10 43065 not incl.

Or Module COB LED 8w 2700k not incl. [17500]
Driver incl.

Materials Aluminium
Aluminio

Weight 0.24 kg / 0.53 lb

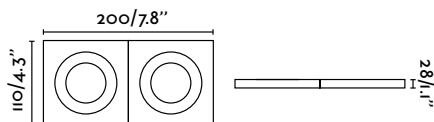
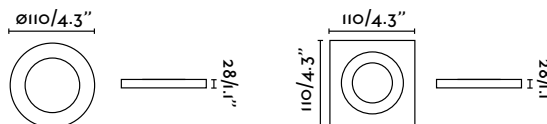
+ info   
43401 43402



REF. 43401




REF. 43402



ARGÓN

Recessed

ORIENTABLE HALOGEN/LED

Ref. **43403**  white
blanco

2xMR 16 50W not incl. [LED 17326]
Transformer not incl. LED [98111050]
Socket / Portalámparas MR 16 4R033 not incl.

Bulb Or 2xMR 16 LED 5W not incl. [14142]
Transformer not incl. [98111050]

Or 2xGU 10 50W not incl. [LED 17316]
Socket / Portalámparas GU 10 43065 not incl.

Or Module COB LED 8w 2700k not incl. [17500]
Driver incl.

Materials Aluminium
Aluminio


Weight 0.47 kg / 1.04 lb


+ info  

NEÓN

Recessed

HALOGEN/LED

Ref. **43399**  white
blanco

Ref. **43400**  white
blanco

1xMR 16 50W not incl. [LED 17326]
Transformer not incl. LED [98111050]
Socket / Portalámparas MR 16 4R033 not incl.

Bulb Or 1xGU 10 50W not incl. [LED 17316]
Socket / Portalámparas GU 10 43065 not incl.

Or Module COB LED 8w 2700k not incl. [17500]
Driver incl.

Materials Aluminium
Aluminio

Weight 0.12 kg / 0.26 lb

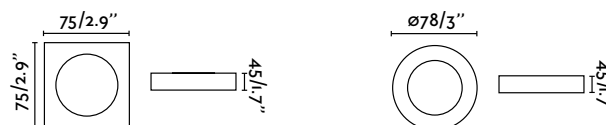
+ info  
43400 43399

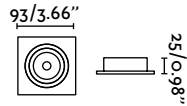


REF. 43400



REF. 43399







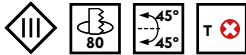
PLANO

Recessed

HALOGEN/LED ORIENTABLE

Ref.	43382	 brushed aluminium aluminio cepillado
	43383	 wenge wengué
Bulb	1xMR16 50W not incl. [LED 17326] Transformer not incl. [43070]. LED [98111050] Socket / Portalámparas MR16 4R033 incl.	
	Or 1xGU10 50W not incl. [LED 17316] Socket / Portalámparas GU10 43065 not incl.	
	Or Module COB LED 8w 2700k not incl. [17500] Driver incl.	
Materials	Aluminium Aluminio	
V/Hz	220-240V / 50-60 Hz	
EEl	A++ to E	
Weight	0.18 kg / 0.40 lb	


+ info



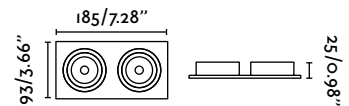
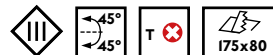
PLANO

Recessed

ORIENTABLE HALOGEN/LED

Ref.	43384	 brushed aluminium aluminio cepillado
Bulb	2xMR16 50W not incl. [LED 17326] Transformer not incl. [43070]. LED [98111050] Socket / Portalámparas MR16 4R033 incl.	
	Or 2xGU10 50W not incl. [LED 17316] Socket / Portalámparas GU10 43065 not incl.	
	Or Module COB LED 8w 2700k not incl. [17500] Driver incl.	
Materials	Aluminium Aluminio	
V/Hz	220-240V / 50-60 Hz	
EEl	A++ to E	
Weight	0.4 kg / 0.88 lb	

+ info



STRUCTURE
ESTRUCTURA



LED BULB
BOMBILLA LED
MR16/GU10

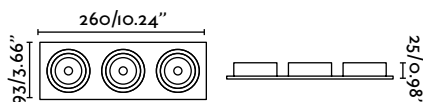


HALOGEN LAMP
LAMPARA HALÓGENA
MR16/GU10



LED MODULE
MÓDULO LED
17500/17501






PLANO

ORIENTABLE HALOGEN/LED

Recessed



Ref.	43386  brushed aluminium aluminio cepillado
Bulb	3xMR I6 50W not incl. [LED 17326] Transformer not incl. [43070]. LED [98111050] Socket / Portalámparas MR I6 4R033 incl. Or 3xGU I0 50W not incl. [LED 17316] Socket / Portalámparas GU I0 43065 not incl. Or Module COB LED 8w 2700k not incl. [17500] Driver incl.
Materials	Aluminium Aluminio
V/Hz	220-240V / 50-60 Hz
EEl	A++ to E
Weight	0.5 kg / 1.10 lb

+ info    

PLANO

ORIENTABLE HALOGEN/LED

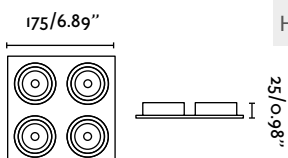
Recessed

Ref.	43388  brushed aluminium aluminio cepillado
	43389  wenge wengué
Bulb	4xMR I6 50W not incl. [LED 17326] Transformer not incl. [43070]. LED [98111050] Socket / Portalámparas MR I6 4R033 incl. Or 4xGU I0 50W not incl. [LED 17316] Socket / Portalámparas GU I0 43065 not incl. Or Module COB LED 8w 2700k not incl. [17500] Driver incl.
Materials	Aluminium Aluminio
V/Hz	220-240V / 50-60 Hz
EEl	A++ to E
Weight	0.67 kg / 1.48 lb





+ info    

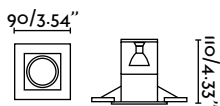


HF
HF



HF **Until stock exhaustion**
Hasta final de stock
Jusqu'à la fin de stock



<p>STRUCTURE ESTRUCTURA</p> 	<p>LED BULB BOMBILLA LED MRI6/GUIO</p> 	<p>HALOGEN LAMP LAMPARA HALÓGENA MRI6/GUIO</p> 	<p>LED MODULE MÓDULO LED 17500/17501</p> 
--	---	--	---

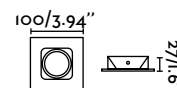


ÓNICE

Recessed

HALOGEN/LED

Ref.	43300		grey gris
	43301		white blanco
Bulb	1xGU10 50W not incl. [LED 17324]		
Materials	Aluminium Aluminio		
V/Hz	100-240V / 50-60 Hz		
EEL	A++ to E		
Weight	0.4 kg / 0.88 lb		




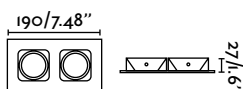
NEUTRÓN

Recessed

**BULB INCLUDED
BOMBILLA INCLUIDA**

HALOGEN/LED

Ref.	43071		matt nickel níquel mate
Bulb	1xGU10 50W incl. [LED 17324]		
Materials	Stainless Steel Acero Inoxidable		
V/Hz	220-240V		
EEL	A to D		
Weight	0.47 kg / 1.04 lb		




NEUTRÓN

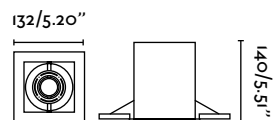
Recessed


**BULB INCLUDED
BOMBILLA INCLUIDA**

HALOGEN/LED

Ref.	43072		matt nickel níquel mate
Bulb	2xGU10 50W incl. [LED 17324]		
Materials	Stainless Steel Acero Inoxidable		
V/Hz	220-240V / 50-60 Hz		
EEL	A to D		
Weight	0.8 kg / 1.76 lb		




**ZIRCÓN****HALOGEN/LED****Recessed**

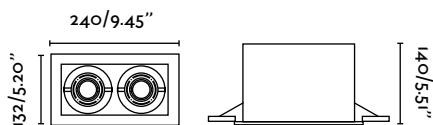
Ref.	43315	 grey gris
Bulb	1xGU10 50W not incl. [LED 17324]	
Materials	Aluminium Aluminio	
V/Hz	100-240V / 50-60 Hz	
EEL	A++ to E	
Weight	0.8 kg / 1.76 lb	

+ info

**ZIRCÓN****HALOGEN/LED****Recessed**

Ref.	43316	 grey gris
Bulb	2xGU10 50W not incl. [LED 17324]	
Materials	Aluminium Aluminio	
V/Hz	100-240V / 50-60 Hz	
EEL	A++ to E	
Weight	1.32 kg / 2.91 lb	

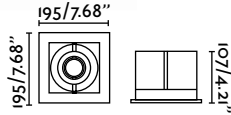
+ info





GINGKO QR111

Recessed with frame



Ref.	03030101		white blanco
	03030102		black negro
	03030103		grey gris
Bulb	1xG53 max 100W not incl.		
Materials	Steel Acero		
V/Hz	12V		
EEL	A		
Weight	1.07 kg / 2.36 lb		

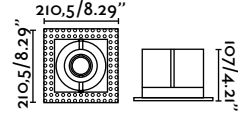
+ info

QR III max 100W - 9811105
QR III LED max 25W - 98111050



GINGKO QR111

Recessed without frame



Ref.	03040102		black negro
Bulb	1xG53 max 100W not incl.		
Materials	Steel Acero		
V/Hz	12V		
EEL	A		
Weight	1.17 kg / 2.58 lb		

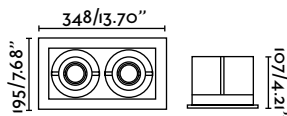
+ info

QR III max 100W - 9811105
QR III LED max 25W - 98111050



GINGKO QR111

Recessed with frame



Ref.	03030201		white blanco
	03030202		black negro
	03030203		grey gris
Bulb	2xG53 max 100W not incl.		
Materials	Steel Acero		
V/Hz	12V		
EEL	A		
Weight	1.5 kg / 3.31 lb		

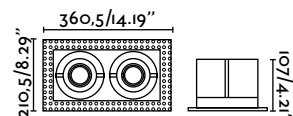
+ info

QR III max 100W - 9811105
QR III LED max 25W - 98111050



GINGKO QR111

Recessed without frame



Ref.	03040202		black negro
Bulb	2xG53 max 100W not incl.		
Materials	Steel Acero		
V/Hz	12V		
EEL	A		
Weight	1.7 kg / 3.75 lb		

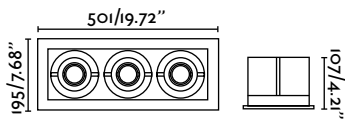
+ info

QR III max 100W - 9811105
QR III LED max 25W - 98111050



GINGKO QR III

Recessed with frame



Ref.	03030301		white blanco
	03030302		black negro
	03030303		grey gris
Bulb	3xG53 max 100W not incl.		
Materials	Steel Acero		
V/Hz	12V		
EEL	A		
Weight	2.37 kg / 5.22 lb		

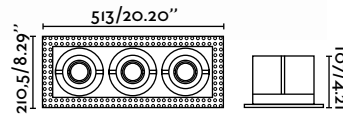
+ info

T QR III max 100W - 9811105
QR III LED max 25W - 9811050



GINGKO QR III

Recessed without frame



Ref.	03040302		black negro
Bulb	3xG53 max 100W not incl.		
Materials	Steel Acero		
V/Hz	12V		
EEL	A		
Weight	2.37 kg / 5.22 lb		

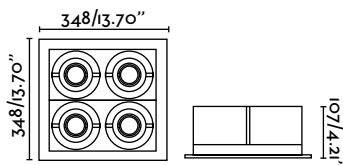
+ info

T QR III max 100W - 9811105
QR III LED max 25W - 9811050



GINGKO QR III

Recessed with frame



Ref.	03030401		white blanco
	03030402		black negro
	03030403		grey gris
Bulb	4xG53 max 100W not incl.		
Materials	Steel Acero		
V/Hz	12V		
EEL	A		
Weight	2.37 kg / 5.22 lb		

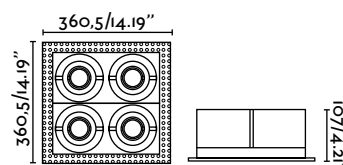
+ info

T QR III max 100W - 9811105
QR III LED max 25W - 9811050



GINGKO QR III

Recessed without frame



Ref.	03040402		black negro
Bulb	4xG53 max 100W not incl.		
Materials	Steel Acero		
V/Hz	12V		
EEL	A		
Weight	2.91 kg / 6.42 lb		

+ info

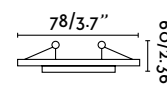
T QR III max 100W - 9811105
QR III LED max 25W - 9811050





FIJO

Recessed



Ref.	43050		white blanco
	43051		matt nickel níquel mate
	43053		aluminium aluminio

Bulb 1xMR16 12V max 50W not incl.
Transformer not incl. [43070]

Or 1xGU10 max 50W 220-240V / 50-60Hz not incl.
Socket / Portalamparas [40065] not incl.

Materials Zamac
Zamac

EEL A++ to E

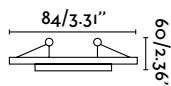
Weight 0.09 kg / 0.20 lb

+ info



MÓVIL

Recessed



Ref.	43056		white blanco
	43057		matt nickel níquel mate
	43058		old gold oro envejecido
	43059		aluminium aluminio

Bulb 1xMR16 12V max 50W not incl.
Transformer not incl. [43070]

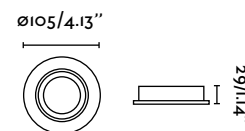
Or 1xGU10 max 50W 220-240V / 50-60Hz not incl.
Socket / Portalamparas [40065] not incl.

Materials Zamac
Zamac

EEL A++ to E

Weight 0.09 kg / 0.20 lb

+ info



QUARK

Recessed

BULB INCLUDED
BOMBILLA INCLUIDA

Ref.	42906		matt nickel níquel mate
Bulb	1xGU10 75W incl.		
Materials	Aluminium Aluminio		
V/Hz	220-240V / 50-60 Hz		
EEL	A to D		
Weight	0.37 kg / 0.82 lb		

+ info

Anouk	359	Maket	372
Ariel	367	Meier	355
Babá	363	Mulan	371
Baobab	365	Nuka	368
Bob	371	Ona	359
Elba	367	Otto	362
Flexi	350	Sam	370
Greta	361	Ter	369
Gru	365	Yap	363
Halo	357		
Ito	355		
Katana	353		
Láser	372		
Lea	373		
Lena	361, 369		
Lente	372		
Leo	366		
Magni	373		




office

Flexi

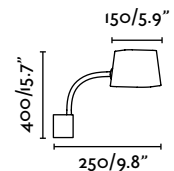
Design: Àlex&Manel
Llusçà

A casual,
very versatile
luminaire line with
infinite positions
and great practical
applications. It can be
used constantly to create
new shapes.







Wall Lamp	
Ref.	<p>29928  white blanco</p> <p>29929  black negro</p> <p>29930  magenta magenta</p> <p>29931  lime green verde lima</p>
Bulb	1xE27 max 15W not incl. [LED 17452]
Materials	Acrylic + Polycarbonate + Steel Acrílico + Policarbonato + Acero
V/Hz	100-240V / 50-60 Hz
EEL	A++ to B
Weight	1.48 kg / 3.26 lb

+ info





Floor Lamp

Ref.	29924		white blanco
	29925		black negro
	29926		magenta magenta
	29927		lime green verde lima

Bulb 1xE27 max 15W not incl. [LED 17452]

Materials Acrylic + Polycarbonate + Steel
Acrílico + Policarbonato + Acero

V/Hz 100-240V / 50-60 Hz

EEL A++ to B

Weight 4.3 kg / 9.48 lb

+ info

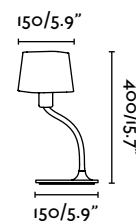
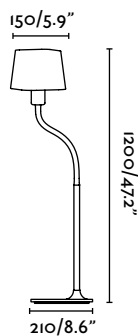






Table Lamp

Ref.	29920		white blanco
	29921		black negro
	29922		magenta magenta
	29923		lime green verde lima

Bulb 1xE27 max 15W not incl. [LED 17452]

Materials Acrylic + Polycarbonate + Steel
Acrílico + Policarbonato + Acero

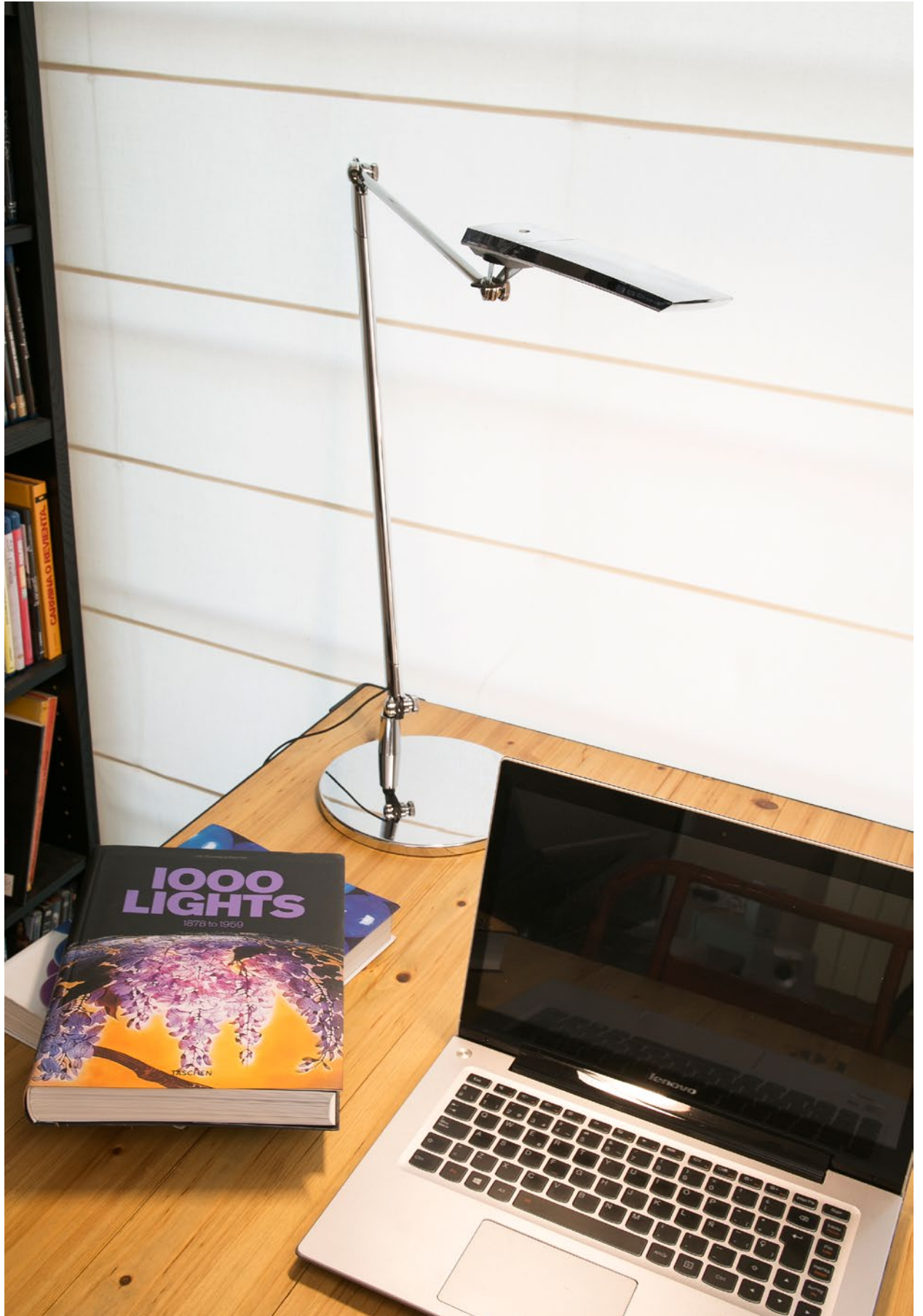
V/Hz 100-240V / 50-60 Hz

EEL A++ to B

Weight 2.39 kg / 5.27 lb

+ info









KATANA [new]

MADE IN JAPAN
HECHO EN JAPON

LED

Desk Lamp

DIMMABLE
DIMABLE

Ref.	55205		chrome cromo
	55206		gold oro
Bulb	SMD LED 7W 2700K-6500K incl.		
Materials	Metal + Aluminium + Polycarbonate Metal + Aluminio + Policarbonato		
V/Hz	220-240V / 50-60 Hz		
EEL	A++ to A		
Weight	3.48 kg / 7.67 lb		

+ info

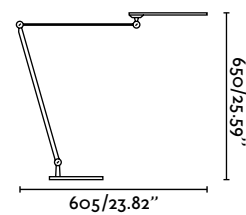
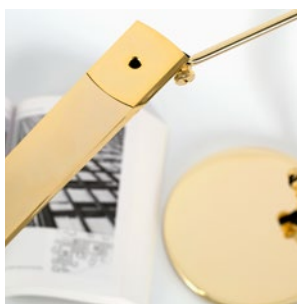


table
accessory
included
accesorio
de mesa
incluido

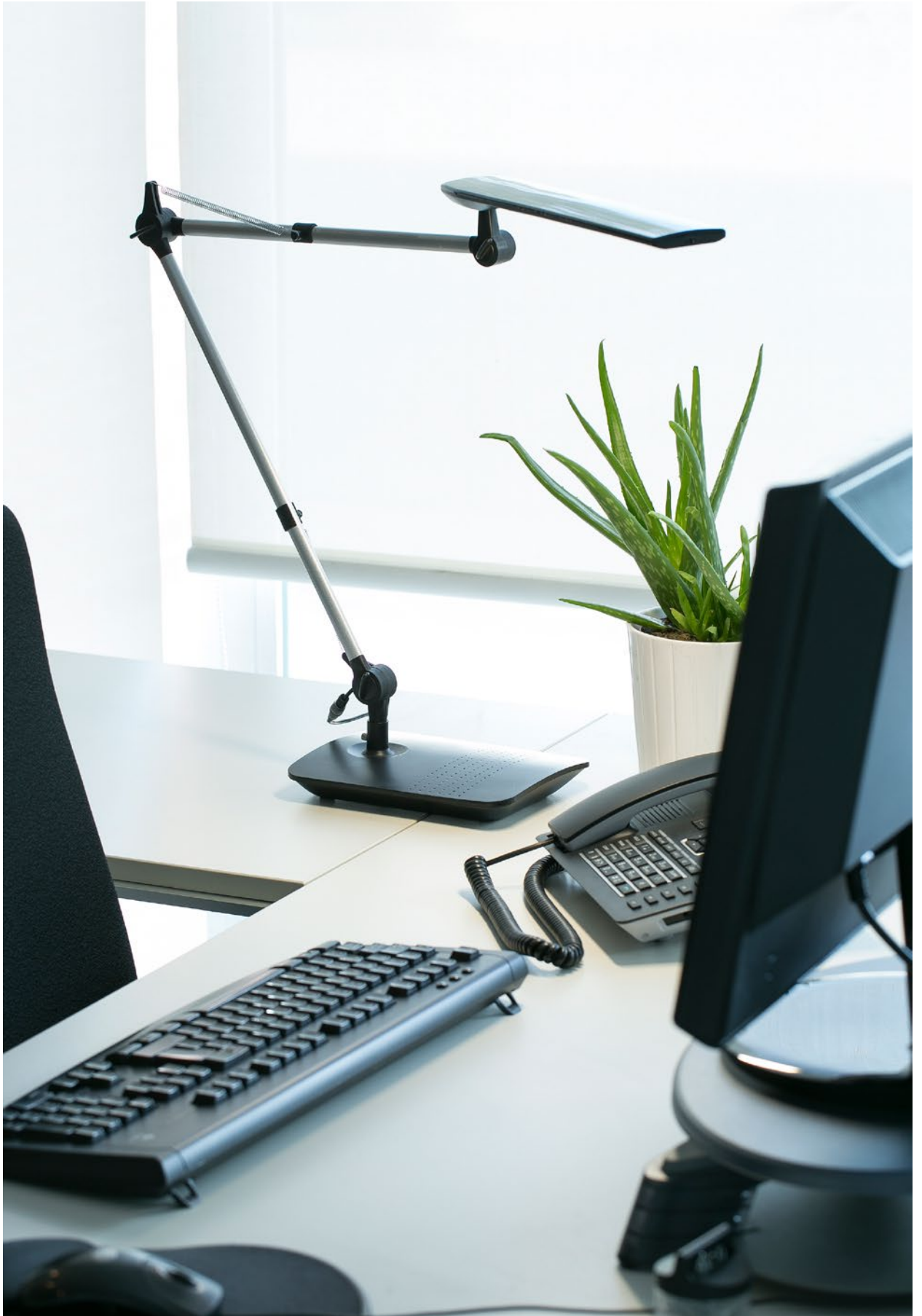


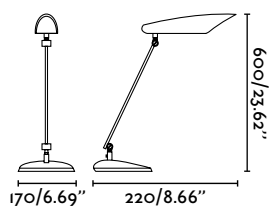
SENSOR




DIFFERENTS TEMPERATURES
DIFERENTES TEMPERATURAS



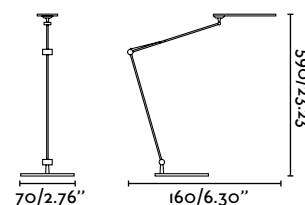


**MEIER** [new]**Desk Lamp**

LED


Ref.	52069	 black negro
Bulb	SMD LED 9W 3000K 550Lm incl.	
Materials	Aluminium + Opal Polycarbonate Aluminio + Policarbonato Opal	
V/Hz	220-240V / 50 Hz	
EEL	A++ to A	
Weight	2.7 kg / 5.95 lb	

+ info

**ITO** [new]

LED

DIMMABLE
DIMABLETOUCH LAMP
LAMPARA TACTIL**Desk Lamp**

Ref.	52071	 black negro
Bulb	SMD LED 5W 3000K 390Lm incl.	
Materials	Aluminium + Opal Polycarbonate Aluminio + Policarbonato Opal	
V/Hz	100-240V / 50-60 Hz	
EEL	A++ to A	
Weight	2.8 kg / 6.17 lb	

+ info

clip
accessory
included
clip accesorio
incluido





WITH SWITCH
CON INTERRUPTOR



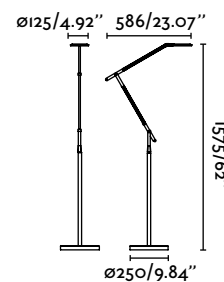
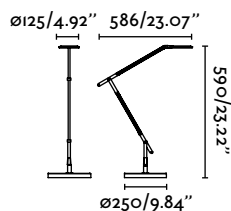
HALO

Table Lamp

LED DIMMABLE
DIMABLE

Ref.	55190	● black negro
Bulb	SMD LED 6W 3000K 500Lm incl.	
Materials	Aluminium + Zinc Aluminio + Zinc	
V/Hz	100-240V / 50-60 Hz	
EEL	A	
Weight	3.83 kg / 8.44 lb	

+ info  DRIVER     I.9M



HALO

Floor Lamp

LED DIMMABLE
DIMABLE

Ref.	55191	● black negro
Bulb	SMD LED 6W 3000K 500Lm incl.	
Materials	Aluminium + Zinc Aluminio + Zinc	
V/Hz	100-240V / 50-60 Hz	
EEL	A	
Weight	4.14 kg / 9.13 lb	

+ info  DRIVER     I.9M



Base to become Wall Lamp (not incl.)
Base para convertirla en Aplique (no incl.)

55192

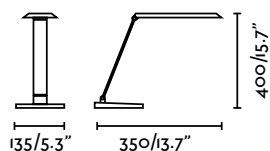
0.17 kg / 0.37 lb

Clip Accessory (not incl.)
Accesorio Pinza (no incl.)



55193

0.21 kg / 0.46 lb

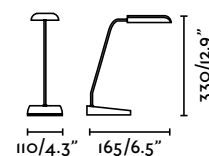


**ANOUK****Desk Lamp**


LED DIMMABLE TOUCH LAMP LAMPARA TÁCTIL

Ref.	53414		white blanco
	53415		black negro
Bulb	SMD LED 8W 4000K 530Lm incl.		
Materials	ABS ABS		
V/Hz	100-240V / 50-60 Hz		
EEl	A++		
Weight	1.09 kg / 2.40 lb		

+ info

**ONA****Desk Lamp**

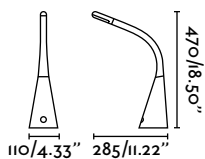
LED DIMMABLE TOUCH SENSOR 3 INTENSIDADES SENSOR TÁCTIL 3 INTENSIDADES

Ref.	52081		white blanco
	Bulb SMD LED 5W 5000-5600K 300Lm incl.		
Materials	ABS ABS		
V/Hz	100-240V / 50-60 Hz		
EEl	A		
Weight	0.77 kg / 1.70 lb		

+ info

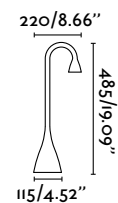






USB
charger**GRETA** [new]**Desk
Lamp**
LED **DIMMABLE**
TOUCH LAMP
LAMPARA TÁCTIL

Ref.	52072		white blanco
	52077		dark grey gris oscuro
Bulb	SMD LED 4W 3000K 430Lm incl.		
Materials	Aluminium + Silicone + Polycarbonate Aluminio + Silicona + Policarbonato		
V/Hz	100-240V / 50-60 Hz		
EEL	A++ to A		
Weight	1.76 kg / 3.88 lb		

+ info

**LENA****Desk
Lamp**
LED **TOUCH SENSOR 3 INTENSITIES**
SENSOR TÁCTIL 3 INTENSIDADES

Ref.	52057		white blanco
	52058		black negro
Bulb	SMD LED 3W 4000K 300Lm incl. Electronic Adaptateur 10.5V 660mA incl.		
Materials	Aluminium + Polycarbonate + Glass + Silicone Aluminio + Policarbonato + Cristal + Silicona		
V/Hz	220-240V / 50-60 Hz		
EEL	A++		
Weight	1.5 kg / 3.31 lb		

+ info







OTTO

LED

Desk Lamp

TOUCH SENSOR 3 INTENSITIES
SENSOR TACTIL 3 INTENSIDADES

Ref.	52064	 black negro
	52065	 white blanco
Bulb	SMD LED 6W 4000K 550Lm incl.	
Materials	Metal + Polycarbonate + Silicone Metal + Policarbonato + Silicona	
V/Hz	100-240V / 50-60 Hz	
Weight	1.29 kg / 2.84 lb	

+ info



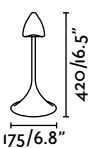
DRIVER 



1.7M



320/12.5"





420/16.5"

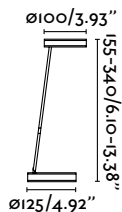
BABÁ

LED

Table LampPLUG & PLAY USB ADAPTER
ENCHUFE Y ADAPTADOR USB

Ref.	51973		white blanco
	51975		grey gris
Bulb	SMD LED 2,4W 6000K 180Lm incl.		
Materials	Aluminium + ABS Aluminio + ABS		
V/Hz	220-240V / 50-60 Hz		
EEL	A++		
Weight	0.78 kg / 1.72 lb		

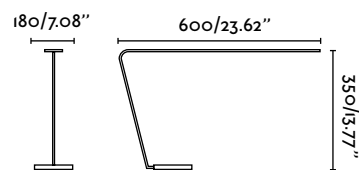
HF




+ info    



HF

**YAP****Table Lamp**

LED

Ref.	55019		black negro
Bulb	SMD LED 7W 3000K 550Lm incl.		
Materials	Aluminium Aluminio		
V/Hz	100-240V / 50-60 Hz		
EEL	A+		
Weight	2 kg / 4.41 lb		

HF





+ info   

HF

Until stock exhaustion
Hasta final de stock
Jusqu'à la fin de stock



BAOBAB**Desk Lamp**

Ref.	51908		white blanco
	51909		black negro
	51910		grey gris
	51911		pistachio green verde pistacho

Bulb 1xE14 II W not incl. [LED 17451]

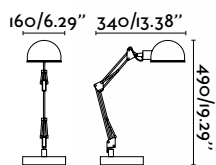
Materials Metal
Metal





V/Hz 100-240V / 50-60 Hz

EEL A++ to B

Weight 1.6 kg / 3.53 lb

+ info

**GRU****Desk Lamp**

Ref.	51916		white blanco
	51917		black negro
	51918		yellow amarillo
	51919		red rojo

Bulb 1xE27 II W not incl. [LED 17453]

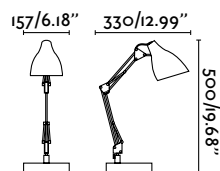
Materials Metal
Metal

V/Hz 100-240V / 50-60 Hz

EEL A++ to B

Weight 1.49 kg / 3.28 lb

+ info

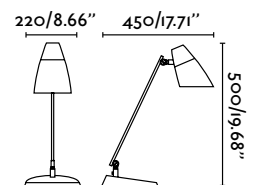




LEO


Desk Lamp

Ref.	52049 ● black negro
Bulb	1xE27 15W not incl. [LED 17453]
Materials	Aluminium + Polycarbonate Aluminio + Policarbonato
V/Hz	100-240V / 50-60 Hz
EEL	A++ to B
Weight	1.6 kg / 3.53 lb



+ info    

ELBA**Desk Lamp**

Ref. **53413**  black negro

Bulb 1x E27 20W not incl. [LED 17452]

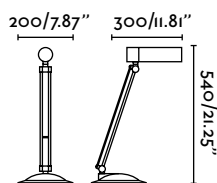
Materials Aluminium + PVC
Aluminio + PVC

V/Hz 100-240V / 50-60 Hz

EEL A to B

Weight 1.7 kg / 3.75 lb

+ info




HF



HF Until stock exhaustion
Hasta final de stock
Jusqu'à la fin de stock

**ARIEL****Desk Lamp**

Ref. **51913**  black negro

51914  grey gris

Bulb 1x E14 11W not incl. [LED 17451]

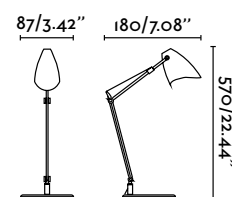
Materials PVC
PVC

V/Hz 100-240V / 50-60 Hz

EEL A++ to B

Weight 1.4 kg / 3.09 lb

+ info





NUKA

Clip

LED

Ref.	54007		electric blue azul eléctrico
	54008		pure green verde vivo

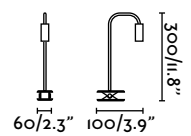
Bulb LED 3W 90Lm 3000K incl.

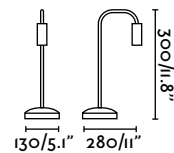
Materials Polycarbonate + Metal
Policarbonato + Metal




V/Hz 100-240V / 50-60 Hz

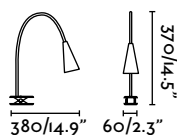
Weight 0.69 kg / 1.52 lb

+ info

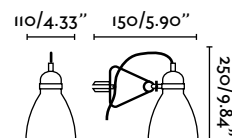



**NUKA****Desk Lamp****LED**

Ref.	54009		red rojo
	54010		electric blue azul eléctrico
	54011		pure green verde vivo

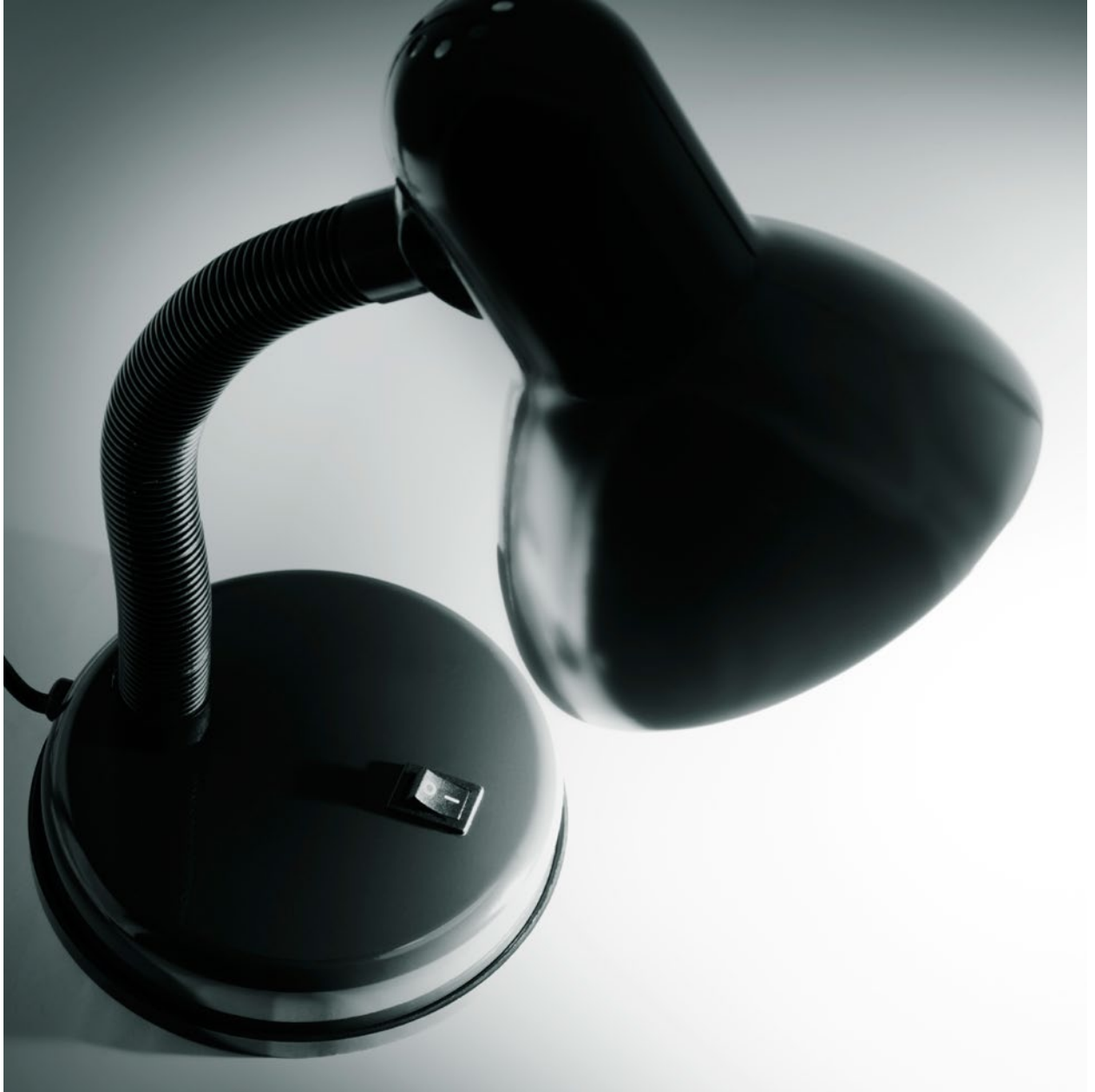
Bulb LED 3W 90Lm 3000K incl.**Materials** Polycarbonate + Metal
Policarbonato + Metal**V/Hz** 100-240V / 50-60 Hz**Weight** 0.4 kg / 0.88 lb**+ info****LENA****Clip****LED**

Ref.	52059		white blanco
	52061		black negro

Bulb SMD LED 3W 4000K 300Lm incl.**Materials** Aluminium + Metal + Silicone
Aluminio + Metal + Silicona**V/Hz** 220-240V / 50-60 Hz**EEL** A++**Weight** 0.55 kg / 1.21 lb**+ info****TER****Clip**




Ref.	51151		grey gris
-------------	--------------	---	--------------

Bulb 1xE14 max 15W not incl. [LED 17451]**Materials** Metal
Metal**V/Hz** 100-240V / 50-60 Hz**EEL** A++ to B**Weight** 0.5 kg / 1.10 lb**+ info**



SAM

Desk Lamp

Ref.	52006		white blanco
	52008		black negro
	52009		red rojo

Bulb 1xE27 max 40W not incl. [LED 17452]

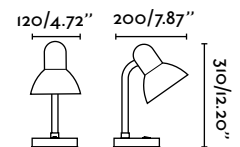
Materials Metal
Metal

V/Hz 100-240V / 50-60 Hz




EEL A++ to E

Weight 0.9 kg / 1.98 lb

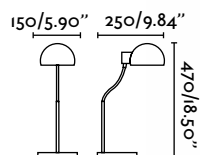
+ info







MULAN**Desk Lamp**

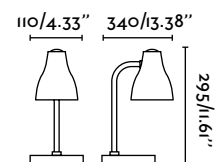
Ref.	51900		white blanco
	51901		black negro
	51902		purple lila
Bulb	1xE27 max 11W not incl. [LED 17452]		
Materials	Metal Metal		
V/Hz	100-240V / 50-60 Hz		
EEL	A++ to B		
Weight	1.49 kg / 3.28 lb		

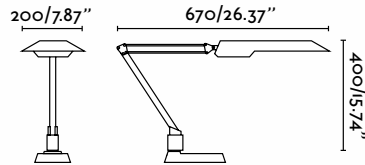
+ info

**BOB****Desk Lamp**

Ref.	52043		orange naranja
	52044		pale green verde pastel
	52045		sky blue azul celeste
	52046		pink rosa
Bulb	1xE27 max 15W not incl. [LED 17452]		
Materials	ABS ABS		
V/Hz	100-240V / 50-60 Hz		
EEL	A++ to B		
Weight	0.88 kg / 1.94 lb		

+ info






LÁSER

Desk Lamp

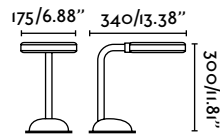
BULB INCLUDED
BOMBILLA INCLUIDA

Ref.	51011	 black negro	HF
Bulb	1 x PL G23q II W 6400K incl.		
Materials	Metal + PVC Metal + PVC		
V/Hz	220-240V / 50-60 Hz		
EEl	A to B		
Weight	2.4 kg / 5.29 lb		

+ info




HF Until stock exhaustion
Hasta final de stock
Jusqu'à la fin de stock



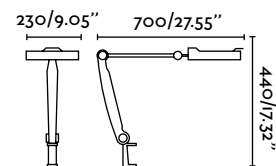
LENTE

Desk Lamp

BULB INCLUDED
BOMBILLA INCLUIDA

Ref.	50064	 black negro
Bulb	1 x G10q T4 12W incl.	
Materials	PVC + Glass PVC + Cristal	
V/Hz	220-240V / 50-60 Hz	
EEl	A to B	
Weight	1.2 kg / 2.65 lb	


+ info



MAKET

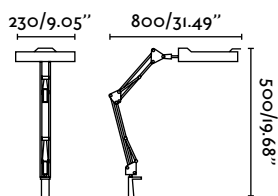
Clip


BULB INCLUDED
BOMBILLA INCLUIDA

Ref.	50052	 white blanco
Bulb	1 x G10q T9 22W incl.	
Materials	PVC PVC	
V/Hz	220-240V / 50-60 Hz	
EEl	A to B	
Weight	2.47 kg / 5.45 lb	

+ info



**MAGNI****Clip**

Ref. **50040**  white
blanco

Bulb 1xG10q T9 22W incl.

Materials Metal
Metal

V/Hz 220-240V / 50-60 Hz

EEL A++ to E

Weight 2.5 kg / 5.51 lb

+ info



BULB INCLUDED
BOMBILLA INCLUIDA



Magni Lens (not incl.)
Cristal Magni (no incl.)

50042

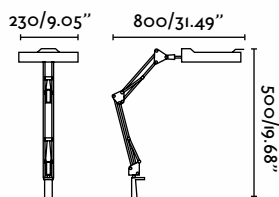
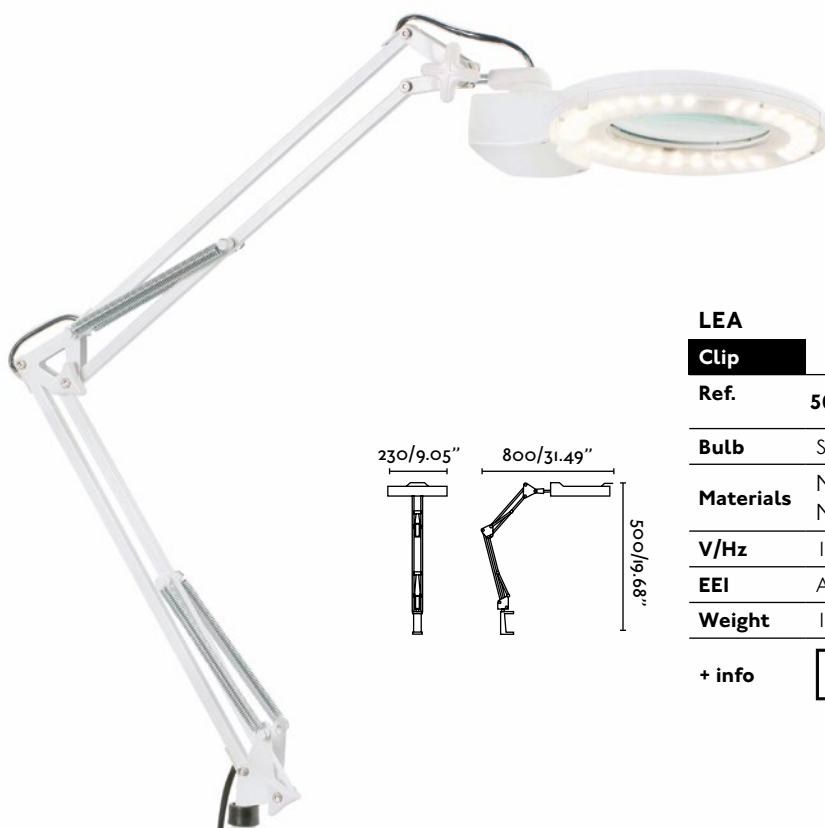
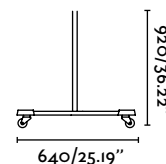
Glass
Cristal
0.42 kg / 0.93 lb



Magni and Lea Base Accessory (not incl.)
Accesorio Pie Magni y Lea (no incl.)


50043

Metal
Metal
5.1 kg / 11.24 lb

**LEA**

LED

Clip

Ref. **50025**  white
blanco

Bulb SMD LED 10W 4000K 616Lm CRI>80 incl.

Materials Metal + Glass
Metal + Cristal

V/Hz 100-240V / 60 Hz

EEL A++

Weight 1.35 kg / 2.98 lb

+ info





Ledstrip / Tira Led 376

Unit 378






LEDSTRIP / TIRA LED

Ref.	19028		white blanco	3000K	1350Lm
	19029		white blanco	5000K	1550Lm

Bulb LED 36W 24VdC incl. Driver not incl. [19031]

EEl A++ to B

Weight 0.35 kg / 0.77 lb

Ref. **19030**  rgb
rgb

Bulb LED 36W 24VdC RGB incl.
Driver not incl. [19031]

EEl A++ to B

Weight 0.35 kg / 0.77 lb

+ info    



Power Supply (not incl.)
Fuente de Alimentación (no incl.)

I9031

100-240 V AC 36W 3A 24V DC
220-240V / 50-60 Hz
A++ to B
0.38 kg / 0.84 lb



Remote Control (not incl.)
Mando a Distancia (no incl.)

I9032



220-240V / 50-60 Hz
A++ to B
0.07 kg / 0.15 lb



Conector with Cable (not incl.)
Conector con Cable (no incl.)

I9036

monocolour

I9037



rgb
rgb



Conector with jack (not incl.)
Conector con jack (no incl.)

I9034

monocolour

I9035



rgb
rgb



Connector (not incl.)
Conector (no incl.)

I9038

monocolour

I9039



rgb
rgb

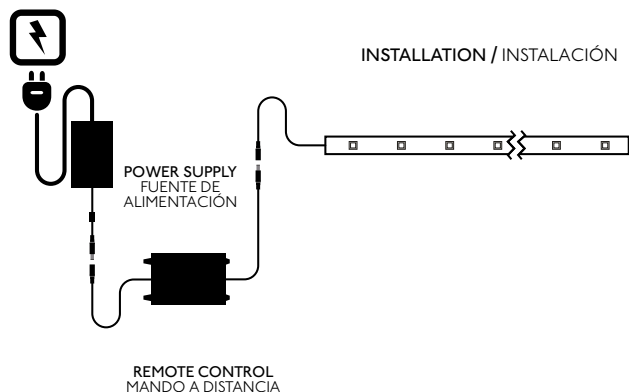


All LED accessories are easy to connect.

Los accesorios para las tiras LED de interior y exterior se unen fácilmente gracias a sus interconectores.

Ledstrip lose IP with the accessories.


Las tiras de LED pierden el IP con los accesorios.



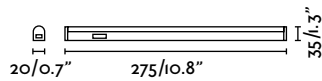
Accessories and driver not included.
Equipo y accesorios no incluidos.




UNIT

Ref.	62086		white blanco
Bulb	LED 4W 4000K 300Lm incl.		
Materials	PVC PVC		
V/Hz	100-240V / 50 Hz		
Weight	0.1 kg / 0.22 lb		

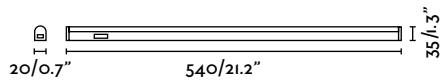
+ info    



UNIT

Ref.	62087		white blanco
Bulb	LED 9W 4000K 720Lm incl.		
Materials	PVC PVC		
V/Hz	100-240V / 50-60 Hz		
Weight	0.15 kg / 0.33 lb		

+ info    



INTERCONNECTION CABLE
CABLE DE INTERCONEXION





Socket MR 16
Portalámparas MR 16

4R033

0.2 kg / 0.44 lb



Socket GU 10
Portalámparas GU 10

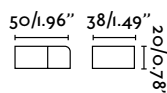
43065

0.05 kg / 0.11 lb

Driver 3W 350mA

46060  white
blanco

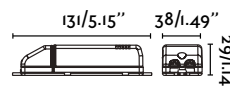
Input 240V - AC 50~60Hz.
Output 350 Ma min. 1W - max. 3W
0.05 kg / 0.11 lb



Driver 16W 350mA

46061  white
blanco

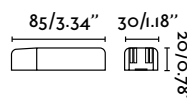
Input 240V - AC 50~60Hz.
Output 350 Ma min. 3W - max. 16W
0.14 kg / 0.31 lb



Electronic Gear 60W
Transformador Electrónico Regulable 60W

43070  white
blanco

Power factor 0.99
Input 220-240V. 50~60 Hz. Output 11,5V 10-60W
0.06 kg / 0.13 lb

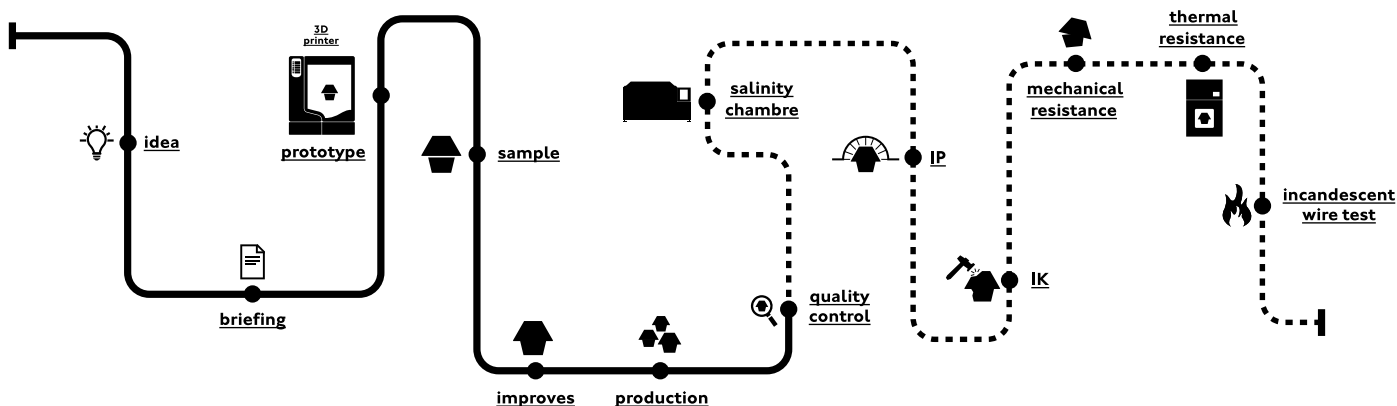


infor
mation

Faro commitment

ENG	ES	FR	PT
<p>Faro Barcelona Technical Laboratory Faro Barcelona has extended the capacity of its Quality Control Department by equipping its laboratory with machinery that can conduct the following tests:</p> <ul style="list-style-type: none"> - IP Tests - Incandescent thread. - Electric shocks. - Thermal and mechanical resistance. - Impacts. - Consumption and power factors. <p>Thanks to these advances, Faro Barcelona has raised the bar regarding the thoroughness of its tests and ensures that European regulations and standards are complied with fully.</p> <p>Faro collaborates on improvements to the environment With its commitment to efficient light bulbs and its contribution to energy saving and the campaign against global warming. In Faro catalogues, next to the standard-use light bulb given for each item, you will see the recommended bulb, highlighted by this symbol: [LED ref.]</p>	<p>Laboratorio técnico propio de faro Barcelona Faro Barcelona ha ampliado la capacidad de su Departamento de Control de Calidad, dotando su laboratorio de una maquinaria capaz de hacer los siguientes ensayos:</p> <ul style="list-style-type: none"> - Pruebas de IP - Hilo incandescente. - Choques eléctricos. - Resistencia térmica y mecánica. - Choques de impacto. - Consumos y factores de potencia. <p>Gracias a estos avances, Faro Barcelona eleva el nivel de rigurosidad en sus ensayos y garantiza el estricto cumplimiento de las normativas y estándares europeos.</p> <p>Faro colabora en la mejora del medio ambiente Apostando por las bombillas eficientes y contribuyendo con el ahorro energético y la lucha contra el calentamiento global. En los catálogos Faro podrá encontrar junto a la bombilla de uso standard de cada artículo cual es la bombilla que recomendamos y lo diferenciamos con este símbolo: [LED ref.]</p>	<p>Laboratoire technique appartenant à faro Barcelona Faro Barcelona a élargi la capacité de son Département de contrôle qualité, en dotant son laboratoire de machines capables de procéder aux essais suivants:</p> <ul style="list-style-type: none"> - Essais d'IP - Fil incandescent. - Chocs électriques. - Résistance thermique et mécanique. - Chocs d'impact. - Consommations et facteurs de puissance. <p>Grâce à ces avancées, Faro Barcelona élève le niveau de rigueur de ses essais et garantit le strict respect des réglementations et normes européennes.</p> <p>Faro participe à l'amélioration de l'environnement En misant sur des ampoules efficaces, en contribuant aux économies d'énergie et en participant à la lutte contre le réchauffement de la planète. Dans les catalogues Faro, vous trouverez, à côté de l'ampoule standard utilisée pour chaque article, l'ampoule recommandée et identifiée parce symbole: [LED ref.]</p>	<p>Laboratório técnico próprio da faro Barcelona A Faro Barcelona ampliou a capacidade do seu Departamento de Controlo de Qualidade, dotando o seu laboratório de uma maquinaria capaz de fazer os seguintes ensaios:</p> <ul style="list-style-type: none"> - Testes de IP - Fio incandescente. - Choques eléctricos. - Resistência térmica e mecânica. - Choques de impacto. - Consumos e factores de potência. <p>Graças a estes avanços, a Faro Barcelona eleva o nível de rigor nos seus ensaios e garante o estrito cumprimento das normas e padrões europeus.</p> <p>A Faro colabora na melhoria do meio ambiente Apostando nas lâmpadas eficientes e contribuindo para a poupança energética e para a luta contra o aquecimento global. Nos catálogos Faro poderá encontrar, junto à lâmpada de uso padrão de cada artigo, a lâmpada recomendada e que se diferencia com este símbolo: [LED ref.]</p>
GER	NL	BL	PL
<p>Eigenes technisches Labor von faro Barcelona Faro Barcelona hat die Leistungsfähigkeit seiner Qualitätssicherungsabteilung durch die Ausstattung seines Labors mit Einrichtungen für folgende Tests erweitert.</p> <ul style="list-style-type: none"> - IP-Tests - Thermische und mechanische Elektroschocks Widerstandskraft - Mechanische Stöße - Verbrauchs- und Leistungsaspekte - Glühfäden <p>Dank dieser Erweiterungen kann Faro Barcelona jetzt seine Produktprüfungen noch wesentlich rigoroser durchführen und eine strikte Erfüllung der europäischen Normen und Standards garantieren.</p> <p>Faro bemüht sich ständig um den Umweltschutz Daher verwenden wir immer mehr effiziente Leuchtmittel und tragen damit zum Einsparen von Energie und zum Kampf gegen die Klimaerwärmung bei. In den Katalogen von Faro finden Sie neben den Standard-Leuchtmitteln für die einzelnen Artikel auch jeweils passende Sparbirnen, die mit folgendem Symbol gekennzeichnet sind: [LED ref.]</p>	<p>Eigen technisch laboratorium van faro Barcelona Faro Barcelona heeft de capaciteit van haar Afdeling Kwaliteitscontrole uitgebreid met een laboratorium waarin de volgende testen kunnen worden uitgevoerd:</p> <ul style="list-style-type: none"> - Testen van de IP-code - Gloeidraad. - Elektrische schokken. - Thermische en mechanische weerstand. - Schok door impact. - Verbruik en vermogensfactoren. <p>Dankzij deze vooruitgang is er bij Faro Barcelona sprake van een hoger striktheidniveau tijdens het testen en garandeert een strikte naleving van de Europese normen en standaards.</p> <p>Faro werkt mee aan de verbetering van het milieu Middels het gebruik van efficiënte lampen. Zo draagt zij bij aan de energiebesparing en aan de strijd tegen de opwarming van de aarde. In de catalogi van Faro treft u naast de lamp voor standaardgebruik van ieder artikel de aanbevolen lamp met laag verbruik aan die met dit symbool wordt onderscheiden: [LED ref.]</p>	<p>Собствена техническа лаборатория на faro Barcelona Faro Barcelona разшири капацитета на своя Отдел за контрол на качеството, като обзаведе лабораториите си с оборудване за осъществяване на следните изпитвания:</p> <ul style="list-style-type: none"> - Изпитвания за степен на защита (IP) - Термична и механична - Токови удари.Сустойчивост. - Удари в твърд предмет. - Консумирана мощност - Нажежена жичка. и коефициент на мощността. <p>По този начин Faro Barcelona повишава точността на изпитванията и гарантира стриктно спазване на европейските.</p> <p>Faro съдейства за подобряване на околната среда чрез използване на енергоспестяващи крушки, с което дава своя принос в борбата с глобалното затопляне. В каталозите на Faro всеки продукт може да се използва както със стандартна, така и с енергоспестяваща крушка, която е препоръчителна и е означена със следния символ: [LED спра.]</p>	<p>Laboratorium techniczne należące do faro Barcelona Firma Faro Barcelona rozszerzyła zakres kompetencji swojego Działu Kontroli Jakości, wyposażając laboratorium w urządzenia wykonujące następujące testy:</p> <ul style="list-style-type: none"> - Próby IP - Włókno żarzenia. - Porażenia prądem. - Wytrzymałość termiczna i mechaniczna. - Wstrząsy. - Zużycie i czynniki mocy. <p>Dzięki tym procedurom firma Faro Barcelona zaostrzyła poziom testów, gwarantując bezwzględne przestrzeganie norm i standardów europejskich.</p> <p>Firma Faro chroni środowisko stawiając na wydajne żarówki i oszczędność energii, przyczyniając się tym samym do walki z globalnym ociepleniem. Oprócz informacji o standardowych żarówkach, katalogi Faro zawierają zalecenia dotyczące żarówek energooszczędnych wyróżnione tym symbolem: [LED odni.]</p>

ITA	GRK	RUS	CZ
<p>Laboratorio tecnico proprio di fano Barcelona</p> <p>Faro Barcellona ha ampliato la capacità del suo Dipartimento di Controllo della Qualità, dotando il suo laboratorio di macchinari in grado di realizzare i seguenti test:</p> <ul style="list-style-type: none"> - Prove di IP - Filo incandescente. - Scariche elettriche. - Resistenza termica e meccanica. - Test di impatto. - Consumi e fattori di potenza. <p>Grazie a questi progressi, Faro Barcelona alza il livello di rigorosità nei suoi test e garantisce il rigido rispetto delle normative e degli standard europei.</p> <p>Faro collabora al miglioramento dell'ambiente</p> <p>Scommettendo sulle lampadine efficienti e contribuendo al risparmio energetico e alla lotta contro il riscaldamento globale.</p> <p>Nei cataloghi Faro potrete trovare, assieme alla lampadina d'uso standard di ogni articolo, la lampadina di basso consumo consigliata e che si distingue con questo simbolo: [LED ref.]</p>	<p>Faro Barcelona Technical Laboratory</p> <p>Η Faro Barcelona έχει διευρύνει τις δυνατότητες του Τμήματος Ελέγχου Ποιότητας, εξοπλίζοντας το εργαστήριό της με μηχανήματα που πραγματοποιούν τα εξής τεστ:</p> <ul style="list-style-type: none"> - Τεστ IP - Νήμα πυρακτώσεως. - Ηλεκτροπληξία. - Θερμική και μηχανική αντοχή. - Κρούση. - Κατανάλωση και παράγοντες ισχύος. <p>Χάρη σε αυτές τις εξελίξεις, η Faro Barcelona αυξάνει το επίπεδο αυστηρότητας στις δοκιμές της και εξασφαλίζει την απόλυτη τήρηση των ευρωπαϊκών κανονισμών και προτύπων.</p> <p>Η Faro συμβάλλει στη βελτίωση του περιβάλλοντος χρησιμοποιώντας αποδοτικούς λαμπτήρες και συμβάλλοντας στην εξοικονόμηση ενέργειας και την καταπολέμηση της υπερθέρμανσης του πλανήτη.</p> <p>Στους καταλόγους της Faro μπορείτε να βρείτε, μαζί με τον συμβατικό λαμπτήρα για κάθε προϊόν, τον συνιστώμενο λαμπτήρα χαμηλής κατανάλωσης που διακρίνεται με αυτό το σύμβολο: [LED αναφ.]</p>	<p>Собственная техническая лаборатория компании fano Barcelona</p> <p>Потенциал Отдела контроля качества компании Faro Barcelona увеличился благодаря появлению в лаборатории оборудования, с помощью которого можно проводить следующие испытания:</p> <ul style="list-style-type: none"> - Тестирование IP - Механическое и - Поражение электрическим током. - Тепловое сопротивление. - Воздействие от столкновения. - Потребление и - Спираль накаливания. <p>Благодаря этому компания Faro Barcelona предъявляет все более жесткие требования к проведению исследований и обеспечивает строгое соответствие европейским стандартам и нормам.</p> <p>Faro заботится об окружающей среде</p> <p>делая ставку на эффективные электрические лампы, позволяющие экономить энергию и бороться с глобальным потеплением.</p> <p>В каталогах Faro можно найти как стандартные лампы различных типоразмеров, так и рекомендуемые энергосберегающие лампы, отмеченные специальным символом: [LED ссы.]</p>	<p>Собственная техническая лаборатория компании fano Barcelona</p> <p>Потенциал Отдела контроля качества компании Faro Barcelona увеличился благодаря появлению в лаборатории оборудования, с помощью которого можно проводить следующие испытания:</p> <ul style="list-style-type: none"> - Тестирование IP - Механическое и - Поражение электрическим током. - Тепловое сопротивление. - Воздействие от столкновения. - Потребление и - Спираль накаливания. <p>Благодаря этому компания Faro Barcelona предъявляет все более жесткие требования к проведению исследований и обеспечивает строгое соответствие европейским стандартам и нормам.</p> <p>Používáním efektivních žárovek přispívá firma Faro</p> <p>Ke zlepšení životního prostředí, úspoře elektrické energie a boji proti globálnímu oteplování.</p> <p>V katalozích Faro naleznete vedle standardní žárovky vhodné pro jednotlivé zboží i doporučenou žárovku s nízkou spotřebou, která je označena tímto symbolem: [LED ref.]</p>



IP Information



ENG	ES	FR	PT
<p>The first digit (IP x...) indicates the protection from solid objects.</p> <p>4 Protected against solid objects bigger than 1 mm.</p> <p>6 Dust tight.</p>	<p>La primera cifra (IP x...) indica la protección del aparato contra la penetración de cuerpos sólidos.</p> <p>4 Protegido contra la penetración de cuerpos sólidos con $\varnothing \geq 1$ mm</p> <p>6 Totalmente protegido contra el polvo</p>	<p>Le premier chiffre (IP x...) indique le degré de protection des parties contre les corps solides.</p> <p>4 Protection contre corps de diamètre supérieur à 1 mm.</p> <p>6 Protection contre toute infiltration de poussière.</p>	<p>O primeiro dígito (IP x...) indica o grau de protecção contra corpos sólidos.</p> <p>4 Protegido contra a penetração de corpos sólidos com $0 > 1$ mm.</p> <p>6 Totalmente protegido contra o pó.</p>
<p>The second digit (IP ...y) indicates protection from moisture.</p> <p>4 Protected against splashing water.</p> <p>5 Protected against water jets.</p> <p>7 Protected against the effects of immersion.</p>	<p>La segunda cifra (IP ...y) indica la protección del aparato contra la lluvia.</p> <p>4 Protegido contra salpicaduras y protección del agua</p> <p>5 Protegido contra chorros de agua</p> <p>7 Protegido contra inundaciones temporales.</p>	<p>Le deuxième chiffre (IP ...y) indique le degré de protection contre l'eau.</p> <p>4 Protection contre projections d'eau de toutes les directions.</p> <p>5 Protection contre jets d'eau de toutes les directions.</p> <p>7 Protection contre immersion à moins d'un metre de profondeur.</p>	<p>O segundo dígito (IP ...y) indica o grau de protecção contra po e chuva.</p> <p>4 Protegido contra projecções de água.</p> <p>5 Protegido contra jactos de água em todas as direcções.</p> <p>7 Protegido contra a imersão temporária.</p>

GER	NL	ITA	GRK
<p>Die erste Ziffer (IP x...) gibt den Schutz des Apparats gegen das Eindringen von festen Körpern an.</p> <p>4 Geschützt gegen das Eindringen von festen Körpern mit $\varnothing \geq 1$ mm.</p> <p>6 Vollkommen gegen Staub geschützt.</p>	<p>Het eerste cijfer (IP x...) geeft de beschermingsgraad weer van het apparaat tegen het binnendringen van vaste elementen.</p> <p>4 Biedt bescherming tegen het binnendringen van vaste elementen met $\varnothing \geq 1$ mm.</p> <p>6 Biedt volledige bescherming tegen stof.</p>	<p>La prima cifra (IP x...) indica la protezione del sistema contro l'ingresso di corpi solidi.</p> <p>4 Protetto contro l'ingresso di corpi solidi con $\varnothing \geq 1$ mm.</p> <p>6 Totalmente protetto contro la polvere.</p>	<p>Το πρώτο νούμερο (IP x...) υποδεικνύει την προστασία της συσκευής κατά της διείσδυσης στερεών αντικειμένων.</p> <p>4 Με προστασία κατά της διείσδυσης στερεών αντικειμένων διαμέτρου $\varnothing \geq 1$ mm</p> <p>6 Με πλήρη προστασία κατά της σκόνης</p>
<p>Die zweite Ziffer (IP ...y) gibt den Schutz des Apparats gegen Regen an.</p> <p>4 Geschützt gegen Spritzer und Schutz gegen Wasser.</p> <p>5 Geschützt gegen Wasserschauer.</p> <p>7 Geschützt gegen zeitweilige Überschwemmungen.</p>	<p>Het tweede cijfer (IP ...y) geeft de beschermingsgraad van het apparaat tegen de regen weer.</p> <p>4 Biedt bescherming tegen spetters en tegen water.</p> <p>5 Biedt bescherming tegen waterstralen.</p> <p>7 Biedt bescherming tegen tijdelijke overstromingen.</p>	<p>La seconda cifra (IP ...y) indica la protezione del sistema contro la pioggia.</p> <p>4 Protetto contro gli spruzzi e l'ingresso di acqua.</p> <p>5 Protetto contro i getti d'acqua.</p> <p>7 Protetto contro inondazioni temporanee.</p>	<p>Το δεύτερο νούμερο (IP ...y) υποδεικνύει την προστασία της συσκευής κατά της βροχής.</p> <p>4 Με προστασία κατά των πιτσιλισμάτων και προστασία νερού</p> <p>5 Με προστασία κατά της ροής νερού</p> <p>7 Με προστασία κατά των παροδικών πλημμυρών</p>

RUS	CZ	BL	PL
<p>Первая цифра (IP x...) указывает на защиту прибора от проникновения твердых тел.</p> <p>4 Защищен от проникновения твердых тел $\varnothing \geq 1$ мм</p> <p>6 Полностью защищен от пыли</p>	<p>První číslice (IP x...) označuje stupeň ochrany přístroje proti průniku pevných částic.</p> <p>4 Chráněno proti průniku pevných částic s $\varnothing \geq 1$ mm</p> <p>6 Kompletně chráněno proti prachu</p>	<p>Първата цифра (IP x...) означава защита на уреда от попадане на твърди тела.</p> <p>4 Защита от попадане на твърди тела с $\varnothing \geq 1$ mm</p> <p>6 Изцяло защитен от прах</p>	<p>Pierwsza cyfra (IP x...) oznacza zabezpieczenie urządzenia przed wnikaniem ciał stałych.</p> <p>4 Zabezpieczono przed wnikaniem ciał stałych za pomocą $\varnothing \geq 1$ mm</p> <p>6 Całkowicie zabezpieczono przed pyłem</p>
<p>Вторая цифра (IP ...y) указывает на защиту прибора от воды.</p> <p>4 Защищен от брызг и попадания воды</p> <p>5 Защищен от потоков воды</p> <p>7 Защищен от проникновения воды при временном затоплении</p>	<p>Druhá číslice (IP ...y) označuje ochranu proti vnikání vlhkosti.</p> <p>4 Ochrana před stříkající vodou.</p> <p>5 Ochrana před tryskající vodou (tlakovou vodou).</p> <p>7 Ochrana při dočasném ponoření.</p>	<p>Втората цифра (IP ...y) указва нивото на защита от влага.</p> <p>4 защитен от пръскаща вода</p> <p>5 защитен от водна струя</p> <p>7 защитен от ефекта на потапяне</p>	<p>Druga z cyfr kodu (IP ...y) oznacza stopień ochrony przed wilgocią.</p> <p>4 ochrona przed rozbryzującą się wodą</p> <p>5 ochrona przed strumieniami wody</p> <p>7 ochrona przed zanurzeniem krótkotrwałym w wodzie</p>

Symbols

	EN	ES	FR	PT	GER	NL
	Has a protective earth Class I protection	Con toma de tierra Aísla. clase I	Avec prise de terre Catégorie de protection I	Com ligação terra Isolamento classe I	Mit Erdung Isolierung der Klasse I	Met aardleiding Isolatie klasse I
	Reinforced or double insulation (class II protection)	Aislamiento clase II	Isolement de protection (classe de protection II)	Isolamento (clase II)	Isolierung der Klasse II	Isolatie klasse II
	Low voltage protection (class III protection)	Aislamiento clase III	Très basse tension de protection (classe protec. III)	Isolamento (clase III)	Isolierung der Klasse III (für montage auf)	Isolatie klasse III
	No incandescent bulb	No bombilla incandescente	Pas utiliser ampoule incandescence	Não use lâmpada incandescente	Nicht verwenden glühlampe	Gebruik geen gloeilamp
	Cable	Cable	Câble	Cabo	Kabel	Kabel
	Switch / Double Switch	Interruptor / Doble Interruptor	Interrupteur / Double Interrupteur	Interruptor / Doble Interruptor	Schalter / Doppelter Schalter	Schakelaar / Dubbele Schakelaar
	Special transformer	Transformador especial	Transformateur spécial	Transformador especial	Spezieller transformator	Speciale transformator
	With equipment, ballast	Con equipo, reactancia	Avec l'équipement, ballast	Com equipamento, equipamento	Ausrüstung, reaktanz	Met uitrusting, reactancia
	Spare part	Repuesto o recambio	Pièce de rechange	Substituição	Ersatzteil oder Austauschteil	Voorraad of vervanging
	Cut out	Agujero para empotrar	Trou d'encastrement	Furo para encastrar	Bohrloch zum Einbauen	Gat om in te bouwen
	Adjustable	Orientable	Orientable	Ajustável	Verstellbar	Verstelbare
	Diopters	Dioptrías	Dioptries	Dioptrias	Dioptrien	Dioptrieën
	Dimmable	Dimable	Réglable	Regulável	Dimmbar	Dimbaar
	Light up / down / up and down	Luz arriba / abajo / arriba y bajo	Lumière de haut / vers les bas / de haut en bas	Luz para cima / baixo / cima e para baixo	Licht auf / nach unten / auf und ab	Lichte omhoog / omlaag / boven en beneden
	Beam angle	Grados apertura	Grades halo lumineux	Notas luz	Light grade	Licht rangen
	Remote control	Mando a distancia	Télécommande	Comando à distancia	Vernbedienung	Dubbele intensiteit
	Recessed box	Caja empotrar	Boîte encastrée	Recesso box	Einbaugeschäuse	Recessed box
	Hours	Horas	Des heures	Horas	Stunden	Uur

	ITA	GRK	RUS	CZ	BL	PL
	Con messa a terra Isola. tipo I	Με γείωση Μόνωση κλάσης I	С контактом заземления Изоляция класс I	S uzemněním Izolace třídy I	Със заземяване Изоляция клас I	Z uziemieniem Izolacja klasy I
	Isolamento tipo II	Μόνωση κλάσης II	Изоляция класс II	Izolace třídy II	Изоляция клас II	Izolacja klasy II
	Isolamento tipo III	Μόνωση κλάσης III	Изоляция класс III	Izolace třídy Ili	Изоляция клас Ili	Izolacja klasy Ili
	Non lampadina a incandescenza	Δεν λάμπα πυρακτώσεως	Нет накаливания	No žárovka	Не крушка с нажежаема жичка	Żarówka nie używać
	Cavo	Καλώδιο	Кабель	Kabel	Καβελ	Kabel
	Interruttore / Doppio Interruttore	Διακόπτης Διπλός / Διακόπτης	Выключатель / Двойной Выключатель	Vypínač / Dvojitý Vypínač	Прекъсвач / Двоен Прекъсвач	Wyłącznik / Podwójny Wyłącznik
	Trasformatore Speciale	Ειδικός Μετασχηματιστής	Специальный Трансформатор	Speciální Transformátor	Специален Трансформатор	Specjalny Transformator
	Con attrezzatura reattanza	Με εξοπλισμό αντίστασης	С оборудованием сопротивление	Včetně zařízení reaktance	С оборудване съпротивление	Zestaw reaktancji
	Pezzi Di Ricambio	Ανταλλακτικό	Сменная Или Запасная Деталь	Náhradní Díly Nebo	Резервни Части Или	Części Zamiennych Lub
	Foro per incasso	Οπή για εντοίχιση	Отверстие для встраивания	Otvor k vložení	Μонтажен отвор	Otwór do mocowania
	Regolabile	Ρυθμιζόμενο	Регулируемый	Nastavitelný	Ρεγυλιруеми	Orientacja
	Dioptrie	Διοπτριών	Диоптрий	Dioptrie	Диоптъра	Dioptrii
	Regolabile	Ροοστάτη	Затемняемый	Stmívatelné	Димиране	Ściemniania
	Luce su / giù / su e giù	Φως εγγραφή / κάτω / εγγραφή και κάτω	Свет вверх / вниз / вверх и вниз	Osvětlit / dolů / nahoru a dolů	Лайт нагоре / надолу / нагоре и надолу	Zapalać się / w dół / w górze iw dół
	Gradi di luce	φως βαθμών	Светлые сорта	Světlo třídy	Светлини марки	Lekkie klasy
	Doppia Intensità	Τηλεχειριστήριο	Дистанционное Управление	Dálkové Ovládání	Дистанционно Управление	Zdalne Sterowanie
	Incasso box	Χωνευτα κουτι	Монтажная коробка	Recessed box	За вграждане box	Puszka
	Ore	Ώρες	Часов	Hodiny	Часове	Godziny

Materials

	ES	FR	PT	GER	NL	ITA
ABS	ABS	ABS	ABS	ABS	ABS	ABS
Acrylic	Acrílico	Acrylique	Acrílico	Acryl	Acryl	Acrílico
Aluminium	Aluminio	Aluminium	Alumínio	Aluminium	Aluminium	Alluminio
Bubble Glass	Cristal Burbuja	Verre bullé	Vidro bolha	Blasenglas	Bubble glas	Vetro bolla
Die Cast Aluminium	Aluminio Inyectado	Fonte d'aluminium	Alumínio fundido	Aluminiumguss	Gegoten aluminium	Ghisa alluminio
Fiber Glass	Fibra de Vidrio	Fibre De Verre	Fibra De Vidro	Fiberglas	Glasvezel	Fibra Di Vetro
Glass	Cristal	Verre	Virdo	Glas	Glas	Vetro
Marble	Mármol	Marbre	Mármore	Marble	Marmeren	Marmo
Metal	Metal	Métal	Metal	Metall	Metaal	Metallo
Opal Acrylic	Acrílico Opal	Acrylique opale	Opal acrílico	Opalacryl	Opaal acrylaat	Acrílico opale
Opal Glass	Cristal Opal	Verre opale	Vidro opal	Opalglas	Opaal glas	Vetro opalino
Opal PMMA	PMMA Opal	PMMA opale	PMMA opal	Opal PMMA	Opaal PMMA	PMMA opale
Opal Polycarbonate	Policarbonato Opal	Polycarbonate opale	Policar-bonato opal	Opal polycarbonat	Opaal polycarbonnat	Policar-bonato opale
Opal PVC	PVC Opal	PVC opale	PVC opal	Opal PVC	Opaal PVC	PVC opale
Optical Glass K9	Cristal Óptico K9	Verre optique	Vidro óptico	Optisches Glas	Optisch glas	Vetro ottico
Papyrus	Papiro	Papyrus	Papiro	Papyrusses	Papyrus	Papiro
Parchment	Pergamino	Parchemin	Pergaminho	Pergament	Perkament	Pergamena
PCB	PCB	PCB	PCB	PCB	PCB	PCB
Plaster	Yeso	Gypse	Gesso	Gips	Gips	Gesso
PMMA	PMMA	PMMA	PMMA	PMMA	PMMA	PMMA
Polycarbonate	Policarbonato	Polycarbonate	Policarbonato	Polycarbonat	Polycarbonaat	Policarbonato
Polymer	Polímero	Polymères	Polímero	Polymer	Polymeer	Polimero
Polypropylene	Polipropileno	Polyéthylène	Poliétileno	Polyethylen	Polyethyleen	Polietilene
PVC	PVC	PVC	PVC	PVC	PVC	PVC
Rattan	Rattan	Rotin	Rattan	Rattan	Rattan	Rattan
Resine	Resina	Résine	Resina	Harz	Hars	Resina
Rustic Glass	Cristal Rústico	Verre rustique	Vidro rústico	Rustikale Glas	Rustieke Glas	Vetro rustico
Silicone	Silicona	Silicone	Silicone	Silicon	Silicone	Silicone
Stainless Steel	Acero Inoxidable	Acier inoxydable	Aço inoxidável	Edelstahl Rostfreier	Roestvrij staal	Acciaio inossi.
Steel	Acero	Acier	Aço	Stahl	Staal	Acciaio
Suede	Ante	Verre Tiffany	Vidro Tiffany	Tiffany-Glas	Tiffany Glas	Vetro Tiffany
Teflon	Teflón	Teflon	Teflon	Teflon	Teflon	Teflon
Textile	Téxtil	Textile	Têxtil	Textile	Textiel	Tessile
Translucent Glass	Cristal Translúcido	Verre translucide	Vidro translúcido	Translucent Glas	Doorschijnend glas	Vetro traslucido
Translucent Polycarbonate	Policarbonato Translúcido	Polycarbonate translucide	Policar-bonato transl.	Translucent polycarbonat	Doorschijnend polycarbo.	Policar-bonato transl.
Transparent Glass	Cristal Transparente	Verre transparent	Vidro transpa.	Transparentem Glas	Transparant glas	Vetro trasparente
Transparent PMMA	PMMA Transparente	PMMA transparent	PMMA transpa.	Transparentem PMMA	Transparant PMMA	PMMA trasparente
Wood	Madera	Bois	Madeira	Holz	Hout	Legno
Zinc	Zinc	Zinc	Zinco	Zink	Zink	Zinco

	GRK	RUS	CZ	BL	PL
ABS	ABS	ABS	ABS	ABS	ABS
Acrylic	Ακρυλικό	Акриловый	Akryl	Акрил	Akrylowy
Aluminium	Αλουμίνιο	Алюминий	Hliník	Алюминий	Aluminium
Bubble Glass	Υαλί φούσκα	Пузырь стекло	Bublina sklo	балон стъкло	Szklane bańki
Die Cast Aluminium	Χυτό αλουμίνιο	Ритого алюминия	Z litého hliníku	Рят алюминий	Odlew aluminiumowy
Fiber Glass	Πολυεστερικεσ	Стекловолокно	Laminát	Фибростъкло	Włókno Szklane
Glass	Υαλί	Стекло	Sklo	Стъкло	Szko
Marble	Μαρμαρα	Мрамор	Mramorová	Мрамор	Marmur
Metal	Μέταλλο	Металл	Kov	Метал	Metal
Opal Acrylic	Opal ακρυλικό	Опалового акрила	Opalový akrylát	Opal акрил	Opal akryl
Opal Glass	Opal γυαλί	Матовое стекло	Opalové sklo	Млечно стъкло	Szko mleczne
Opal PMMA	Opal PMMA	PMMA ακριλωση	Opal PMMA	Opal PMMA	Mlecznego PMMA
Opal Polycarbonate	Opal πολυάνθρακας	Opal поликарбонат	Opal polykarbonát	Opal поликарбонат	Mlecznego Poliwęglan
Opal PVC	Opal PVC	Opal PVC	Opal PVC	Opal PVC	PVC Poliwęglan
Optical Glass K9	Οπτική γυαλί	Оптическое стекло	Optické sklo	Оплично стъкло	Szka optycznego
Papyrus	Πάπυρος	Папирус	Papyrus	Ραпуrus	Papyrus
Parchment	Περγαμηνή	Пергамент	Pergamen	Пергамент	Pergamin
PCB	PCB	PCB	PCB	PCB	PCB
Plaster	Γύψος	Гипс	Sádrovec	Гипс	Gips
PMMA	PMMA	PMMA	PMMA	PMMA	PMMA
Polycarbonate	Πολυκαρβονικά	Поликарбонат	Polykarbonát	Поликарбонат	Poliwęglan
Polymer	Πολυμερές	Полимер	Polymer	Полимер	Polimer
Polypropylene	Πολυαιθυλένιο	Полиэтилен	Polyethylen	Полиэтилен	Polietylen
PVC	PVC	PVC	PVC	PVC	PVC
Rattan	Rattan	Ротанг	Rattan	Rattan	Rattan
Resine	Ρητινουχο	Смола	Pryskyřice	Смола	Żywica
Rustic Glass	ρουστίκ Γυαλί	Сельский стекла	Rustikální sklo	Рустик стъкло	Rustic Szko
Silicone	Σιλικονη	Силикон	Silikonová	Силикон	Silikon
Stainless Steel	Ανοξείδωτο χάλυβα	нержавеющая сталь	Nerez	нерждаема стомана	Stali nierdzewnej
Steel	χάλυβας	сталь	Ocel	Стомана	Stal
Suede	Tiffany Γυαλί	Тиффани Стекла	Tiffany Skleněné	Tiffany Стъкло	Tiffany Szko
Teflon	Τεφλόν	Тефлон	Teflon	Τεφλοново	Teflon
Textile	Υφάσματα	Текстильный	Textilní	Τекстилен	Włókienniczy
Translucent Glass	Διαφανές γυαλί	Прозрачные стекла	Translucent stъкло	Průhledné sklo	Przezroczyste szklo
Translucent Polycarbonate	Διαφανές πολυάνθρακας	Прозрачные поликарбонат	Translucent polykarbonát	Průhledné поликарбонат	Przezroczyste Poliwęglan
Transparent Glass	Διαφανές γυαλί	Прозрачное стекло	Průhledné sklo	Прозрачно стъкло	Przezroczystego szkła
Transparent PMMA	Διαφανές PMMA	Прозрачное PMMA	Průhledné PMMA	Прозрачно PMMA	Przezroczystego PMMA
Wood	Ξύλο	Дерево	Dřevo	Дърво	Drewno
Zinc	Ψευδάργυρος	Цинк	Zinek	Цинк	Cynk

Finishes



General information

ENG	ES	FR
<p>The technical information detailed in our catalogue can be modified in order to improve the features or design of our products.</p> <p>Faro Barcelona keeps the right to cancel or modify any model without prior notice and without any cause for complaints.</p> <p>The conditions, technical characteristics and prices of the products that appear in this catalogue are the effective ones in the date of impression of the catalogue except for typographical error and are subject to possible changes.</p> <p>The catalogue prices are public prices.</p> <p>RATES DO NOT INCLUDE VAT.</p> <p>Price list not valid for Italy and Switzerland.</p> <p>Returned goods shall only be accepted, after prior notice being given to LOREFAR, on the grounds of being defective and never on the basis of broken glass or missing parts. In such cases, please contact us so that we can send you the required parts as a matter of urgency. Exchanges or returns of goods in good condition will not be accepted. In the event of express acceptance by LOREFAR, a 20% charge shall be incurred, on receipt and checking, for depreciation and classification of the goods.</p>	<p>La información referente a nuestros productos puede ser modificada con el fin de mejorar las características técnicas o de diseño.</p> <p>Faro Barcelona se reserva el derecho de anular o modificar cualquier modelo sin previo aviso y sin que sea motivo de reclamaciones.</p> <p>Las condiciones, características y precios de los productos que aparecen en este catálogo son los vigentes en la fecha de impresión del catálogo salvo error tipográfico y están sujetos a posibles modificaciones.</p> <p>Los precios mostrados son precios de venta al público (PVP).</p> <p>IVA NO INCLUIDO EN TARIFA</p> <p>Tarifa no válida para Italia y Suiza.</p> <p>Previa comunicación a Lorefar sólo se aceptará la mercancía devuelta por defectuosa, nunca por cristales rotos o falta de algún componente. En estos casos rogamos se pongan en contacto con nosotros para enviarnos urgentemente las piezas requeridas.</p> <p>No se admitirán cambios ni devoluciones de mercancía en buen estado. En caso de aceptación explícita por parte de Lorefar, a su recepción y comprobación se emitirá un cargo del 20% en concepto de depreciación y clasificación de la mercancía.</p>	<p>L'information qui se réfère à nos produits peut être modifiée afin d'améliorer les caractéristiques technique ou de design.</p> <p>Faro Barcelona se réserve le droit d'annuler ou de modifier n'importe quel modèle sans préavis et sans que cela soit motif de réclamations.</p> <p>Les conditions, caractéristiques et prix des produits qui apparaissent dans ce catalogue sont celles en vigueur à la date d'impression du catalogue sauf erreur typographique et sont susceptible d'être modifiées ultérieurement.</p> <p>Les prix du catalogue son les prix de vente public .</p> <p>IVA NON COMPRISE DANS LE TARIF.</p> <p>Liste de prix pas valable pour l'Italie et la Suisse.</p> <p>Seule sera acceptée en retour la marchandise défectueuse, et ce après communication à LOREFAR. LOREFAR n'acceptera jamais de retour pour du verre brisé ou pour l'absence d'un composant quelconque. Dans ces derniers cas, nous vous prions de vous mettre en contact avec nous afin que nous vous fassions parvenir dans les plus brefs délais les pièces nécessaires. La marchandise en bon état ne sera ni reprise ni échangée. En cas d'acceptation explicite de sa part, LOREFAR retiendra 20% au titre de la dépréciation et de la classification du produit.</p>
PT	GER	NL
<p>A informação referente aos nossos produtos pode ser modificada com o fim de melhorar as características técnicas ou de desenho.</p> <p>A Faro Barcelona reserva-se o direito de anular ou modificar qualquer modelo sem aviso prévio e sem que seja motivo de reclamações.</p> <p>As condições, características e preços dos produtos que aparecem neste catálogo são os vigentes na data de impressão do catálogo salvo erro tipográfico e estão sujeitos a possíveis modificações. Os preços mostrados são preços de venda ao público (PVP).</p> <p>IVA NÃO INCLUIDO NA LISTA DE PREÇOS</p> <p>Lista de preços não é válido para a Itália e Suíça.</p> <p>Mediante comunicação prévia à Lorefar, apenas se aceitará a mercadoria devolvida por defeito, nunca por vidros partidos ou falta de algum componente. Nestes casos pedimos que entrem em contacto connosco para lhes enviarmos urgentemente as peças requeridas.</p> <p>Não serão admitidas alterações nem devoluções de mercadoria em bom estado. Em caso de aceitação explícita por parte da Lorefar, na sua recepção e comprovação emitir-se-á um débito de 20% a título de depreciação e classificação da mercadoria.</p>	<p>Die Information über unsere Produkte kann im Zusammenhang mit den Verbesserungen ihrer technischen Eigenschaften und ihres Designs jederzeit geändert werden.</p> <p>Faro Barcelona behält sich das Recht vor, seine Modelle jederzeit und ohne vorheriger Ankündigung vom Markt zu nehmen, ohne dass sich daraus ein Anrecht auf Beschwerden ableiten könnte.</p> <p>Die Bedingungen, Eigenschaften und Preise der Produkte in diesem Katalog gelten zum Datum der Drucklegung des Katalogs vorbehaltlich Druckfehler und können jederzeit geändert werden. Diese Preise gelten für den Direktverkauf an den Kunden.</p> <p>DIE MEHRWERTSTEUER IST NICHT IN DEN PREISEN EINGESCHLOSSEN</p> <p>Preisliste gilt nicht für Italien und die Schweiz.</p> <p>Nach vorheriger Kommunikation kann Lorefar die Rücklieferung von schadhafter Ware akzeptieren, jedoch niemals wegen beschädigten Glasteilen oder fehlenden Komponenten. In letzteren Fällen setzen Sie sich bitte zwecks schneller Zusendung der notwendigen Teile in Verbindung.</p> <p>Wir tauschen keine Waren in gutem Zustand um oder nehmen sie zurück. Bei ausdrücklicher Annahme durch Lorefar nach Erhalt und Überprüfung stellen wir Ihnen 20% des Preises für Wertverminderung und Handhabung der Ware in Rechnung.</p>	<p>De informatie over onze producten kan gewijzigd worden met als doel de technische eigenschappen of het design te verbeteren.</p> <p>Faro Barcelona behoudt zich het recht voor onaangekondigd modellen te schrappen of te wijzigen en zonder dat dit aanleiding tot een klacht vormt.</p> <p>De voorwaarden, eigenschappen en prijzen van de producten in deze catalogus zijn geldig op het moment van druk van de catalogus tenzij sprake is van een drukfout. Zij zijn onderhevig aan mogelijke wijzigingen. De getoonde prijzen betreffen verkoopprijzen.</p> <p>Btw NIET BIJ DE PRIJS INBEGREPEN</p> <p>Taifra niet geldig voor Italië en Zwitserland.</p> <p>Lorefar aanvaardt uitsluitend defecte terugggezonden goederen nadat zij hierover van tevoren op de hoogte is gesteld. Dit geldt niet voor gebroken glas of het ontbreken van onderdelen. In deze gevallen wordt u verzocht met ons contact op te nemen zodat wij u zo snel mogelijk de gewenste onderdelen kunnen toezenden.</p> <p>Ruilen of terugsturen van goederen in correcte staat is niet toegestaan. In geval van uitdrukkelijke aanvaarding door Lorefar wordt bij ontvangst en controle een heffing van 20% voor waardevermindering en classificatie van de goederen toegepast.</p>
ITA	GRK	RUS
<p>La informazione che si riferisce ai nostri articoli può essere soggetta a modifiche con il fine di migliorare le caratteristiche, tecniche o di design, dei nostri prodotti. Faro Barcelona si riserva il diritto di annullare o modificare qualsiasi modello senza previo avviso e senza che sia motivo di reclami.</p> <p>Le condizioni, caratteristiche e prezzi dei prodotti che compaiono in questo catalogo sono quelli vigenti alla data della stampa del catalogo ad eccezione di errori tipografici e sono soggetti a possibili modificazioni.</p> <p>I prezzi indicati sono prezzi di vendita al pubblico.</p> <p>IVA NON INCLUSA IN LISTINO.</p> <p>Il listino non è valido per l'Italia e la Svizzera.</p> <p>LOREFAR accetta previa comunicazione, solo la merce restituita perché difettosa; in nessun caso accetterà la merce restituita per presenza di vetri rotti o per mancanza di qualche componente. In questi casi vi preghiamo di contattarci per potervi mandare al più presto i pezzi richiesti.</p> <p>Non si effettuano cambi né si ammettono restituzioni di merci in buono stato. In caso di accettazione esplicita da parte di LOREFAR, al momento del ricevimento e della verifica della merce si emetterà un addebito del 20% a titolo di deprezzamento e classificazione.</p>	<p>Οι πληροφορίες σχετικά με τα προϊόντα μας ενδέχεται να τροποποιηθούν με στόχο τη βελτίωση των τεχνικών χαρακτηριστικών ή του σχεδίου.</p> <p>Η Faro Barcelona διατηρεί το δικαίωμα ακύρωσης ή τροποποίησης οποιουδήποτε μοντέλου χωρίς προηγούμενη προειδοποίηση και χωρίς αυτό να αποτελεί αιτία απαίτησης επιστροφής χρημάτων.</p> <p>Οι όροι, τα χαρακτηριστικά και οι τιμές των προϊόντων που παρουσιάζονται σε αυτόν τον κατάλογο είναι αυτά που ισχύουν κατά την ημερομηνία της εκτύπωσης του καταλόγου, εκτός τυπογραφικών λαθών, και υπόκεινται σε αλλαγές. Οι τιμές που εμφανίζονται είναι τιμές λιανικής.</p> <p>Ο ΦΠΑ ΔΕΝ ΣΥΜΠΕΡΙΛΑΜΒΑΝΕΤΑΙ ΣΤΗΝ ΤΙΜΗ</p> <p>Μετά από συνηνόηση με τη Lorefar, γίνονται αποδεκτές επιστροφές μόνο αν πρόκειται για ελαττωματικά εμπορεύματα και όχι για θραύση κρυστάλλων ή απουσία κάποιου στοιχείου. Στις περιπτώσεις αυτές, παρακαλούμε να ερθετε σε επαφή μαζί μας για να σας στείλουμε επείγοντως τα απαιτούμενα μέρη.</p>	<p>Информация относящаяся к нашей продукции может быть модифицирована с целью улучшить технические или внешние характеристики.</p> <p>Faro Barcelona сохраняет за собой право аннулировать или модифицировать любую модель без предупреждения и без того что это послужит причиной для жалоб.</p> <p>Δεν γίνονται αποδεκτές αλλαγές ή επιστροφές για εμπορεύματα σε καλή κατάσταση. Σε περίπτωση ρητής απόδοσης εκ μέρους της Lorefar, κατά την παραλαβή και τον έλεγχο τους θα πραγματοποιηθεί χρέωση 20% για έξοδα απόσβεσης και ταξινόμησης των εμπορευμάτων.</p> <p>Условия, характеристики и цены на изделия, указанные в данном каталоге, действительны на дату его выпуска, за исключением опечаток в каталоге, и могут быть изменены. В каталоге указаны различные цены.</p> <p>БЕЗ УЧЕТА НДС</p> <p>В соответствии с правилами, компания Lorefar принимает возврат изделий только при наличии дефектов, но ни в коем случае не при разбитии стекла или отсутствии какой-либо детали. В таком случае, пожалуйста, свяжитесь с нами, чтобы мы отправили вам необходимые детали.</p> <p>Товар в рабочем состоянии не подлежит обмену или возврату. В случае подтверждения компанией Lorefar наличия дефектов, после возврата и проверки, начисляется 20% стоимости с учетом амортизации и классификации товаров.</p>
CZ	BL	PL
<p>Technické informácie uvedené v katalogu môžu byť modifikované za účelom zdokonalování vlastností svítidel nebo jejich designu.</p> <p>Producent Faro Barcelona si vyhradzuje právo konstrukčních změn nabízených modelů bez předcházejícího oznámení a tato skutečnost nemůže být předmětem jakékoli stížnosti či reklamace.</p> <p>Podmínky, technické specifikace a ceny produktů uvedené v katalogu jsou platné ke dni vydání katalogu. Producent si vyhradzuje právo konstrukčních změn nabízených modelů, pokud tyto nepovedou k zásadním změnám charakteru výrobků. Informace z tohoto katalogu postrádají platnosti v den vydání katalogu nového.</p> <p>VŠECHNY CENY JSOU UVEDENY BEZ DPH.</p> <p>Zboží může být vráceno pouze po předchozím souhlasu od společnosti PAXI, na základě poruchy nebo vady ovšem nikdy na základě poškozeného skla nebo chybějícího dílu. V takových případech nás, prosím, kontaktujte, abychom Vám mohli požadované části svítidel urgentně zaslat. Výměny nebo vracení zboží v dobrém technickém stavu je nepřijatelné.</p>	<p>Техническата информация, представена в нашият каталог, може да бъде променяна с цел да подобри представянето или дизайна на продуктите.</p> <p>Фаро Барселона си запазва правото да отмени или променя всеки модел без предварително осведомяване и без това да се счита причина за оплаквания.</p> <p>Условията, техническите характеристики и цените на продуктите показани в този каталог са ефективни към датата на отпечатването на каталога, с изключение на грешки при отпечатване и са обект на възможни промени.</p> <p>Цените в каталога са публичните цени.</p> <p>ЦЕНИТЕ НЕ ВКЛЮЧВАТ ДДС.</p> <p>Връщане на закупена стока ще да бъдат приети единствено след писмено осведомяване на ЛОРЕФАР на основание дефекти и в никакъв случай на основание съвкупно стъкло или липсващи части.</p> <p>Размяна или връщане на стока в добро състояние няма да бъде извършвана. В случай на спешно приемане от ЛОРЕФАР 20 % такса ще бъде наложена за приемане и проверка, за обезценяване и класификация на продуктите.</p>	<p>Informacje techniczne wyszczególnione w naszym katalogu mogą być modyfikowane w celu poprawienia właściwości lub zornictwa produktów.</p> <p>Faro Barcelona ma prawo do anulowania i modyfikowania każdego z modeli bez uprzedniego informowania i nie przyjmuje skarg z tego tytułu.</p> <p>Warunki, opis techniczny oraz ceny artykułów, które pojawiają się w katalogu są aktualne do czasu przedruku katalogu za wyjątkiem pomyłek w druku, które podlegają ewentualnej zmianie. Ceny w katalogu są cenami publicznymi.</p> <p>CENY NIE ZAWIERAJĄ STAWKI VAT.</p> <p>Ewentualne zwroty mogą być zaakceptowane po przedniej zgodzie przez Lorefar na podstawie stwierdzenia, że są wadliwe, nigdy nie przyjmowane są zwroty artykułów, z powodu słabej jakości szkła czy brakujących części, w tym przypadku prosimy o kontakt w celu wysłania potrzebnych części w trybie natychmiastowym.</p> <p>Wymiany lub zwroty artykułów w dobrym stanie nie będą zaakceptowane. W przypadku wyrażonej akceptacji przez Lorefar, 20% opłaty może być poniesione na otrzymanie i sprawdzenie, w celu sklasyfikowania uszkodzonego artykułu.</p>

fan



indoor



outdoor



bulbs



professional

BARCELONA
DRESSLight[®]
by **faro**



made in **Spain**

Tango

Design: Estudi Ribaudí



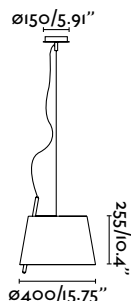
Tango is inspired by the search of closeness between object and person.



Pendant Lamp

Ref.	DT00062G		grey gris
	DT00062N		black negro
Bulb	1xE27 100W not incl. [LED 17455]		
Materials	Satin Nickel + Textile Níquel Satinado + T�xtil		
V/Hz	220-240V / 50-60 Hz		
EEL	A++ to B		
Weight	2.8 kg / 6.17 lb		

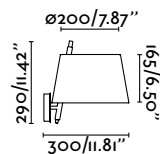
+ info  



Wall Lamp

Ref.	DT00063G		grey gris
	DT00063N		black negro
Bulb	1xE27 40W not incl. [LED 17455]		
Materials	Satin Nickel + Textile N�quel Satinado + T�xtil		
V/Hz	220-240V / 50-60 Hz		
EEL	A++ to B		
Weight	1.4 kg / 3.09 lb		

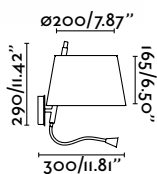
+ info 



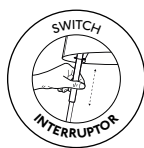
Wall Lamp + Reader

Ref.	DT00064G		grey gris
	DT00064N		black negro
Bulb	1xE27 40W not incl. [LED 17455] + LED 3W 2700K incl.		
Materials	Satin Nickel + Textile N�quel Satinado + T�xtil		
V/Hz	100-240V / 50-60 Hz		
EEL	A++ to B		
Weight	1.8 kg / 3.97 lb		

+ info 







WITH SWITCH
CON INTERRUPTOR

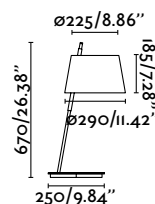


Table Lamp

Ref. **DT00065G** grey / gris
DT00065N black / negro

Bulb 1x E27 60W not incl. [LED 17455]

Materials Satin Nickel + Textile / Níquel Satinado + Tèxtil

V/Hz 220-240V / 50-60 Hz

EEL A++ to B

Weight 3.1 kg / 6.83 lb

+ info



Floor Lamp

Ref. **DT00066G** grey / gris
DT00066N black / negro

Bulb 1x E27 100W not incl. [LED 17455]

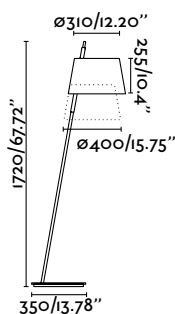
Materials Satin Nickel + Textile / Níquel Satinado + Tèxtil

V/Hz 220-240V / 50-60 Hz

EEL A++ to B

Weight 11 kg / 24.25 lb

+ info



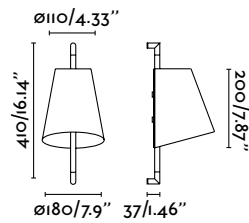
Hanoi

Design: Pepe Llaudet





Hanoi
represents the
beauty of simplicity.
The harmony of contrast.
Hanoi projects optimal
soft and warm light for
comfort stay.





Wall Lamp

Ref.	DT00073	 	natural wood+pearl grey madera natural+gris perla
Bulb	1xE27 42W not incl. [LED 17455]		
Materials	Satin Nickel + Special Paper Níquel Satinado + Papel Especial		
V/Hz	220-240V / 50-60 Hz		
EEL	A++ to E		
Weight	2 kg / 4.41 lb		

+ info



ADJUSTABLE SWITCH
INTERRUPTOR REGULABLE

Etna

Design: Pepe Llaudet



Etna comes about from the blend of noble, rustic materials like solid wood and exclusive materials such as handmade Pyrex glass. This original and modern ceiling lamp with a strong personality is available in 3 sizes and 2 finishes that adapt to the needs of each room.



Pendant Lamp

Ref.	DV00032	 black wood madera negra
	DV00035	 natural wood madera natural

Bulb 1xGU 10 7W not incl. [97001]

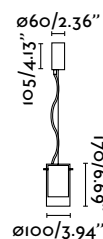
Materials Blown Glass + Wood + Lacquered Metal
Vidrio soplado + Madera + Metal Lacado

V/Hz 220-240V / 50-60 Hz

EEL A++ to A

Weight 1.15 kg / 2.54 lb

+ info

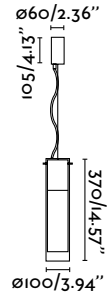
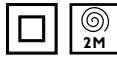




Pendant Lamp

Ref.	DV00033	● black wood madera negra
	DV00036	● natural wood madera natural
Bulb	1xGU10 LED 7W not incl. [97001]	
Materials	Blown Glass + Wood + Lacquered Metal Vidrio soplado + Madera + Metal Lacado	
V/Hz	220-240V / 50-60 Hz	
EEl	A++ to A	
Weight	3 kg / 6.61 lb	

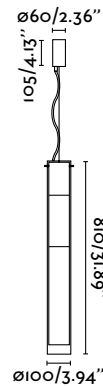
+ info



Pendant Lamp

Ref.	DV00034	● black wood madera negra
	DV00037	● natural wood madera natural
Bulb	1xGU10 LED 7W not incl. [97001]	
Materials	Blown Glass + Wood + Lacquered Metal Vidrio soplado + Madera + Metal Lacado	
V/Hz	220-240V / 50-60 Hz	
EEl	A++ to A	
Weight	6.1 kg / 13.45 lb	

+ info

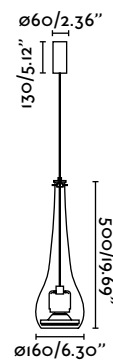


Eter

Design: Faro Team

Craftsmanship opens the door to modernity as the age-old tradition of glassblowing comes to the forefront. Innovation in glass, chromed steel and halogen lights bring a touch of light to any space.





Pendant Lamp

Ref.	29816	transparent transparente
Bulb	1xQR III LED 20W not incl. [LED 175II]	
Materials	Pyrex Blown Glass + Red Fiber Cable + Chrome Vidrio Pyrex Soplado + Cable de Fibra Rojo + Cromo	
V/Hz	220-240V / 50-60 Hz	
Weight	2.5 kg / 5.51 lb	

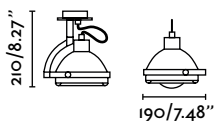
+ info

Glop

Design: Faro Team

A collection with a strong presence and particular elegance that can successfully fit in with any decorative style. Transparencies, chrome and red fiber combined to provide a touch of distinction to any kind of room.



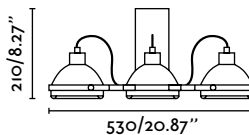


Wall Lamp

2 POSITIONS
2 POSICIONES

Ref.	DV00006	transparent transparente
Bulb	1xGU10 ES-III 75W not incl. [14042]	
Materials	Pyrex Blown Glass + Chrome + Red Fiber Cable Vidrio Pyrex Soplado + Cromo + Cable de Fibra Rojo	
V/Hz	220-240V / 50-60 Hz	
EEL	A++ to B	
Weight	1.9 kg / 4.19 lb	

+ info



Ceiling Lamp

Ref.	DV00012	transparent transparente
Bulb	4xGU10 ES-III 75W not incl. [14042]	
Materials	Pyrex Blown Glass + Chrome + Red Fiber Cable Vidrio Pyrex Soplado + Cromo + Cable de Fibra Rojo	
V/Hz	220-240V / 50-60 Hz	
EEL	A++ to B	
Weight	7.75 kg / 17.09 lb	

+ info

Coffee

Design: Faro Team

Opal glass luminaire in the shape of a coffee cup designed for lighting cafes, restaurants, kitchens and hotels. Its sympathetic inverted presence gives it an original twist.



COFFEE BOWL

Pendant Lamp

Ref. **DV00013**  transparent
transparente

Bulb 1xG9 40W not incl. [15615]

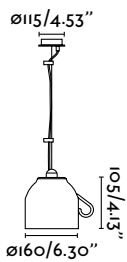
Materials Pyrex Blown Glass + Chrome
Vidrio Pyrex Soplado + Cromo

V/Hz 220-240V / 50-60 Hz

EEL A++ to E


Weight 1.6 kg / 3.53 lb

+ info



COFFEE CUP

Pendant Lamp

Ref. **DV00007**  transparent
transparente

Bulb 1xG9 40W not incl. [15615]

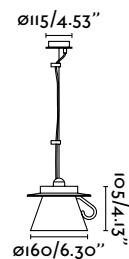
Materials Pyrex Blown Glass + Chrome
Vidrio Pyrex Soplado + Cromo

V/Hz 220-240V / 50-60 Hz

EEL A++ to E

Weight 1.5 kg / 3.31 lb


+ info



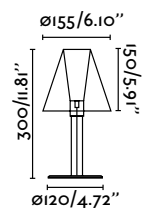


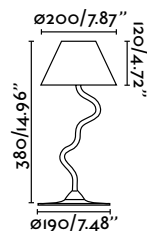
BURAN

Table Lamp

Ref.	DV00021  transparent transparente
Bulb	1xG9 40W not incl. [15615]
Materials	Transparent & Opal Pyrex Blown Glass + Red Fiber Cable Cristal Pyrex Soplado Transparente y Opal + Cable de Fibra Rojo
V/Hz	220-240V / 50-60 Hz
EEL	A++ to E
Weight	1.63 kg / 3.59 lb

+ info





EOLO

Table Lamp

Ref.	DV00001	transparent transparente
Bulb	1xG9 40W not incl. [15615]	
Materials	Pyrex Blown Glass Vidrio Pyrex Soplado	
V/Hz	220-240V / 50-60 Hz	
EEl	A++ to E	
Weight	2.4 kg / 5.29 lb	

+ info

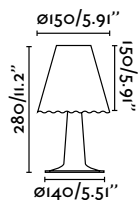


MISTRAL

Table Lamp

Ref.	DV00019	transparent transparente
Bulb	1xG9 40W not incl. [15615]	
Materials	Pyrex Blown Glass Vidrio Pyrex Soplado	
V/Hz	220-240V / 50-60 Hz	
EEl	A++ to E	
Weight	1.65 kg / 3.64 lb	

+ info



Ref.	Pag.	Ref.	Pag.	Ref.	Pag.
02090101	323	19031	377	20045	19
02090201	323	19032	377	20046	19
03030101	344	19034	377	20047	25
03030102	344	19035	377	20048	25
03030103	344	19036	377	20049	19
03030201	344	19037	377	20050	19
03030202	344	19038	377	20100	127
03030203	344	19039	377	28370	107
03030301	345	20000	19	28371	107
03030302	345	20001	19	28380	105
03030303	345	20002	19	28381	105
03030401	345	20003	21	28382	105
03030402	345	20004	21	28383	105
03030403	345	20005	21	28384	105
03040102	344	20006	23	28385	105
03040202	344	20007	23	28390	35
03040302	345	20008	23	28391	35
03040402	345	20009	21	28394	35
03002	314	20010	23	28398	137
03004	314	20011	23	28399	137
03005	313	20012	23	28401	111
03006	313	20016	19	28406	121
03007	311	20017	19	28407	121
03008	311	20018	19	28408	111
03009	311	20019	21	28413	205
03010	311	20020	21	28414	205
03011	312	20021	37	28415	205
03012	312	20022	37	29293	160
03013	313	20023	37	29294	133
03014	313	20024	37	29295	133
03015	312	20025	39	29296	133
03016	312	20026	39	29297	133
17500	337	20027	38	29300	154
19028	376	20028	38	29306	61
19029	376	20029	39	29307	59
19030	376	20030	39	29308	59

Ref.	Pag.	Ref.	Pag.	Ref.	Pag.
29309	61	29878	65	29942	45
29310	61	29879	65	29943	45
29311	59	29880	65	29944	47
29312	59	29881	67	29945	47
29313	61	29882	67	29946	44
29326	27	29883	67	29947	45
29327	27	29884	67	29948	45
29328	27	29886	77	29949	47
29329	27	29887	77	29950	48
29330	27	29888	77	29951	48
29331	27	29889	77	29952	51
29332	29	29890	79	29953	51
29333	29	29891	79	29954	49
29335	29	29894	79	29955	49
29336	29	29895	79	29956	51
29468	137	29906	109	29957	51
29764	117	29907	109	29958	49
29789	137	29920	351	29959	49
29793	113	29921	351	29960	57
29796	113	29922	351	29961	57
29816	403	29923	351	29962	55
29854	217	29924	351	29963	55
29855	217	29925	351	29964	55
29864	53	29926	351	29965	55
29865	53	29927	351	29966	56
29866	52	29928	350	29967	56
29867	52	29929	350	29968	57
29868	53	29930	350	29969	57
29869	53	29931	350	29970	54
29871	199	29935	48	29971	54
29872	199	29936	51	29974	209
29873	63	29937	49	29975	209
29874	63	29938	49	29976	209
29875	63	29939	51	29977	209
29876	63	29940	47	29980	41
29877	65	29941	44	29981	41

Ref.	Pag.	Ref.	Pag.	Ref.	Pag.
29982	41	40561	183	40941	191
29983	41	40562	197	40942	191
29984	40	40563	197	40994	223
29985	40	40564	197	40995	222
29986	43	40580	181	40996	223
29987	43	40581	181	41019	223
29988	43	40582	181	41020	223
29989	43	40583	181	41021	222
29991	211	40584	181	41022	222
29992	211	40585	181	41023	221
29993	211	40586	180	41025	221
29995	33	40587	180	42840	319
29996	33	40588	180	42841	319
29997	31	40589	181	42842	319
29998	31	40590	181	42862	321
29999	33	40591	181	42863	321
40062	219	40592	197	42865	321
40070	219	40593	197	42866	321
40100	199	40594	197	42867	321
40101	199	40791	185	42868	321
40215	327	40792	184	42870	321
40225	327	40793	185	42871	321
40391	193	40794	185	42872	321
40411	193	40871	193	42874	321
40421	193	40880	187	42875	321
40550	182	40881	186	42876	321
40551	182	40882	187	42878	321
40552	182	40883	187	42879	321
40553	183	40884	187	42880	321
40554	183	40885	186	42906	347
40555	183	40886	187	42910	329
40556	183	40887	187	42911	329
40557	183	40891	193	42912	329
40558	183	40938	188	42913	329
40559	183	40939	189	42919	327
40560	183	40940	189	42921	329

Ref.	Pag.	Ref.	Pag.	Ref.	Pag.
42923	323	43403	339	52046	370
42924	323	46027	335	52049	366
42925	327	46029	335	52057	361
42926	325	46030	335	52058	361
42927	325	46060	379	52059	369
42928	322	46061	379	52061	369
42929	323	4R033	379	52064	362
42930	323	50025	373	52065	362
43050	347	50040	373	52069	355
43051	347	50042	373	52071	355
43053	347	50043	373	52072	361
43056	347	50052	372	52077	361
43057	347	50064	372	52081	359
43058	347	51011	372	53413	367
43059	347	51151	369	53414	359
43065	379	51900	371	53415	359
43070	379	51901	371	54007	368
43071	342	51902	371	54008	368
43072	342	51908	365	54009	369
43300	342	51909	365	54010	369
43301	342	51910	365	54011	369
43315	343	51911	365	55019	363
43316	343	51913	367	55190	357
43382	340	51914	367	55191	357
43383	340	51916	365	55192	357
43384	340	51917	365	55193	357
43386	341	51918	365	55205	353
43388	341	51919	365	55206	353
43389	341	51973	363	57069	117
43396	337	51975	363	57200	115
43397	337	52006	371	57201	115
43398	337	52008	371	57202	115
43399	339	52009	371	57205	115
43400	339	52043	370	57207	115
43401	339	52044	370	61005	305
43402	339	52045	370	61006	305

Ref.	Pag.	Ref.	Pag.	Ref.	Pag.
61008	306	62981	301	63120	269
61046	220	62982	301	63124	285
61048	255	62983	295	63125	285
61049	255	62984	295	63126	285
61064	257	62985	295	63127	285
61066	257	62986	252	63128	285
61068	257	62987	252	63129	285
61070	255	62988	225	63146	271
61071	255	63006	271	63147	263
62086	378	63007	302	63148	263
62087	378	63008	271	63151	249
62105	227	63009	270	63156	248
62106	227	63010	303	63157	309
62107	227	63011	303	63158	309
62108	227	63012	303	63167	235
62109	227	63027	249	63172	243
62110	227	63028	305	63173	243
62112	213	63038	269	63174	243
62113	213	63040	251	63175	242
62115	215	63041	251	63176	241
62120	207	63043	269	63177	241
62121	207	63046	253	63178	241
62122	207	63047	253	63186	247
62123	207	63056	307	63187	225
62124	207	63057	307	63195	225
62125	207	63064	252	63199	235
62961	291	63065	253	63200	246
62962	291	63069	249	63201	247
62963	291	63075	304	63202	247
62964	291	63076	305	63215	279
62965	301	63084	307	63216	278
62966	301	63087	306	63217	279
62968	295	63088	306	63218	279
62969	295	63089	306	63219	141
62974	271	63090	250	63231	221
62980	301	63105	251	63237	281

Ref.	Pag.	Ref.	Pag.	Ref.	Pag.
63238	279	63397	298	64175	163
63239	278	63398	298	64176	163
63240	279	63399	297	64177	261
63268	283	63403	297	64178	261
63269	283	63404	299	64180	131
63270	277	63405	299	64180	287
63271	277	64100	170	64181	131
63272	277	64101	171	64181	287
63273	277	64102	171	64182	131
63274	276	64104	169	64182	287
63275	276	64108	173	64183	131
63276	277	64109	171	64183	287
63277	277	64125	173	64184	131
63278	237	64127	151	64185	131
63279	237	64128	151	64186	131
63280	331	64129	175	64187	131
63281	333	64131	175	64188	297
63282	333	64132	167	64190	281
63283	333	64133	145	64191	141
63284	239	64134	145	64192	201
63285	239	64137	149	64193	201
63286	331	64138	233	64198	282
63288	239	64139	165	64199	282
63289	330	64140	167	64200	283
63290	331	64141	167	64201	283
63309	299	64142	167	64202	201
63310	299	64145	165	64203	201
63320	265	64152	142	64210	201
63321	265	64153	142	64211	201
63322	267	64154	142	64212	201
63323	267	64159	143	64213	201
63325	259	64160	143	64214	201
63326	259	64162	143	64215	201
63393	293	64170	135	64218	17
63394	293	64172	135	64219	17
63395	293	64174	159	64220	17

Ref.	Pag.	Ref.	Pag.	Ref.	Pag.
64221	17	67020	95	68544	96
65046	129	68138	101	68545	97
65047	129	68139	101	68546	99
65071	145	68144	153	68547	97
65079	147	68153	155	68548	97
65080	147	68283	157	68549	99
65081	152	68284	157	68561	153
65090	149	68285	157	68562	169
65133	233	68286	157	68563	169
65136	289	68298	289	68569	155
65137	289	68333	112	71363	235
66137	245	68334	112	71366	235
66183	245	68417	91	71367	235
66185	245	68418	91	71526	231
66186	245	68419	93	71527	231
66190	74	68420	93	75509	229
66191	75	68423	113	75510	229
66194	75	68461	165	75511	229
66200	73	68462	119	98310589	319
66201	73	68463	119	98310689	319
66204	72	68500	83	DT00062G	395
66205	73	68501	83	DT00062N	395
66208	69	68502	83	DT00063G	395
66209	69	68503	83	DT00063N	395
66210	71	68504	81	DT00064G	395
66211	71	68505	81	DT00064N	395
66212	69	68506	81	DT00065G	397
66213	69	68507	81	DT00065N	397
66214	71	68513	85	DT00066G	397
66215	71	68514	85	DT00066N	397
66872	161	68515	84	DT00073	399
66873	161	68530	87	DV000007	407
67000	315	68531	87	DV000001	409
67002	315	68532	89	DV000006	405
67018	95	68533	89	DV000012	405
67019	94	68535	159	DV000013	407

Ref.	Pag.
DV00019	409
DV00021	408
DV00032	400
DV00033	401
DV00034	401
DV00035	400
DV00036	401
DV00037	401

Mod	Pag.	Mod	Pag.	Mod	Pag.
Acacia	307	Coccote	131	Glop	405
Adra	304	Code	231	Greta [new]	361
Aina [new]	159	Coffee	407	Groe	239
Akane	107	Conik [new]	17	Gru	365
Álamo	188	Cono	245	Halita	145
Alder	167	Copic	281	Halo	357
Alma [new]	151	Cora	302	Handy [new]	205
Aluminio	170	Cráter	165	Hanoi	399
Ambo	246	Creta	84	Hat	111
Ami	298	Cup [new]	180	Henlein	257
Ángulo	249	Dallas	235	Homs	235
Anouk	359	Dana	327	Hotel	44
Argón	339	Dante	306	Ibiscus	249
Ariel	367	Data	250	Ikon	259
Art	149	Degas	255	Indo	271
Aurea	215	Dino	307	Iris [new]	293
Azor	311	Diula	252	Ito [new]	355
Babá	363	Dix	121	Janet	289
Banker	112	Doka	267	Juliet [new]	221
Baobab	365	Dot	323	Kalo	315
Bar	167	Eaco	241	Kant	327
Berni	27	Ebba	327	Kao	297
Bird	229	Elba	367	Katana [new]	353
Black	117	Elsa [new]	237	Klimt	255
Bliss	111	Eolo	409	Koi	329
Bob	371	Erma [new]	149	Lampetta	217
Bongo	173	Eter	403	Laos	265
Buran	408	Etna	400	Lara	94
Calda	263	Fijo	347	Láser	372
Celia	219	Flat	319	Lass	270
Chapí	113	Flexi	350	Lea	373
Charlotte [new]	169	Foro [new]	299	Led Mini	329
Cheras	242	Fusta [new]	35	Ledstrip	376
Cilo	171	Galaxia	184	Lena	361, 369
Clara [new]	151	Gina	235	Leni	305
Cloe	297	Gingko	344	Lente	372

Mod	Pag.	Mod	Pag.	Mod	Pag.
Leo	366	Neón	339	Prosa	159
Liana [new]	155	Neu	331	Quark	347
Linda	59	Neutrón	342	Radón	337
Link	63	Nexo	115	Ram	199
Liria	248	Nidia	113	Ray	220
Lise	77	Nido	155	Rel	282
Liz [new]	147	Niger	269	Relax	269
Logos	301	Nitro	173	Retro	19
Loke	222	Nord	331	Ring	182
Luce	163	Nudos	101	Roda	225
Lula	105	Nuka	368	Roma	117
Lumiere	257	Nusa	323	Ronda	299
Lune	193	Ola	252	Room	209
Lupe [new]	31	Olaf	237	Rose [new]	152
Magma	137	Óleo	175	Saba	96
Magni	373	Ona	359	Sabana	211
Maket	372	Ónice	342	Sac	74
Mali	161	Ora	79	Sam	370
Malmo	330	Oslo	239	Sami	221
Margot	153	Otto	362	Seven	157
Marlin	145	Ovo	227	Sinki	225
Meier [new]	355	Pam	143	Sintra	251
Mia	163	Papillon	133	Siret	261
Mika	186	Papua	119	Siria	169
Mild	259	Pauline [new]	127	Snow	239
Mistral	409	Pérgamo	154	Sogo [new]	291
Mitic	91	Petra	219	Son [new]	322
Mix	54	Planet [new]	129	Squad	141
Moma	81	Plano	340	Star	193
Monet	257	Plas	333	Stella [new]	225
Mont	321	Platillo	171	Suau [new]	207
Móvil	347	Plec [new]	69	Sunny	253
Mulan	371	Plot	201	Sven [new]	283
Murano	160	Pluma	135	Sweet	48
Nan	141	Portos	251	Swing	213
Nanko	165	Pote	285	Tango	395

Mod	Pag.
Tavern	153
Tecto	276
Ted	325
Tempo	142
Ter	369
Terma	263
Thana	87
Tirso	335
Tod	325
Tola	295
Transfer	175
Tree	52
Tub	221
Twin	245
Unit	378
Vera	249
Versus	109
Vesper	40
Volta	37
Vuk [new]	297
Winch	72
Yap	363
Yes	331
Yuca	303
Zircón	343

LOREFAR
c/Dinámica, 1
08755 Castellbisbal
Barcelona, Spain
faro@lorefar.com
www.faro.es

Spain / Portugal / Andorra
Phone: +34 937 723 949 / 902 165 166
Fax: +34 937 720 018
E-mail: faro@lorefar.com

Export
Phone: +34 937 723 965
Fax: +34 937 723 967

Contact us from anywhere
E-mail: france@faro.es
italia@faro.es
middleeast@faro.es
europe@faro.es
america@faro.es
africa@faro.es
asiapacific@faro.es



faro.es